



Elite, Elite Dual, CoreX2 & Core Series of Inspection Systems



**Speed, Accurate, Easy.
Measure On.**

**Speed, Accurate, Easy.
Measure On.**

George Products Company, Inc.
110 Sleepy Hollow Drive
Middletown, DE 19709
(302) 449-0199 PHONE
(302) 449-0288 FAX

www.georgeproducts.com

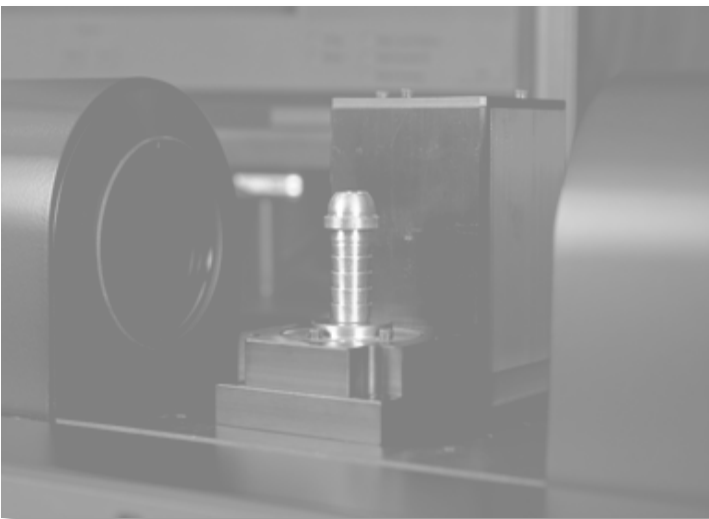
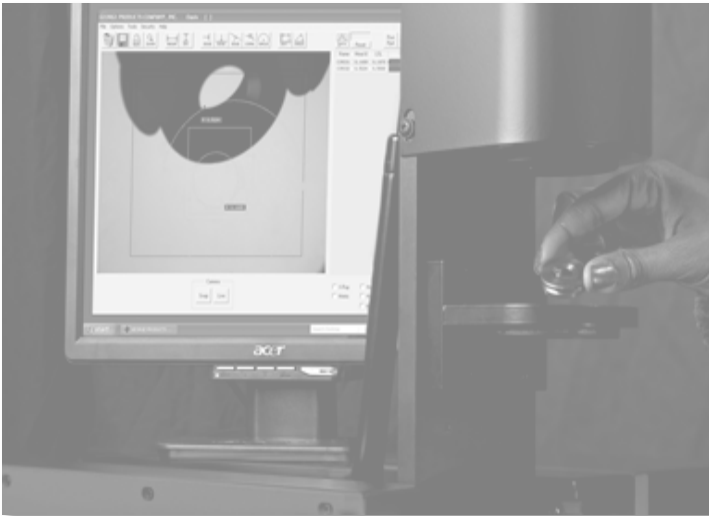
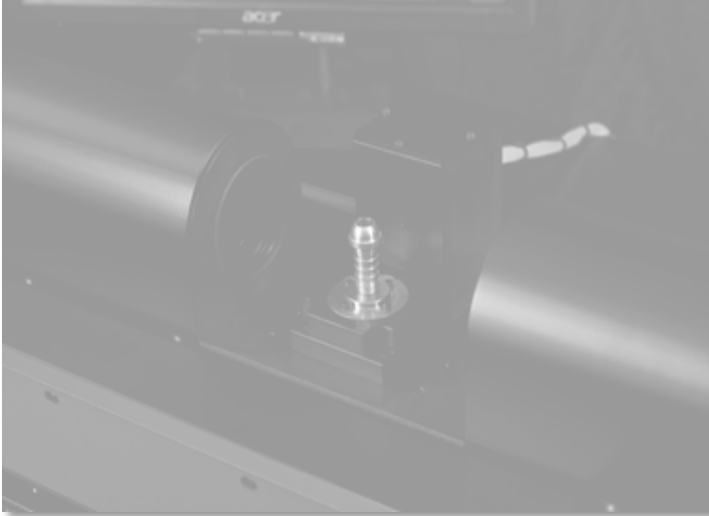

Table of Contents

Why Use OASIS?.....	3
How Does it Work?	4
Part Programming in OASIS.....	6
Search Feature & Part Recognition.....	7
Automatic Focus & Light Setting.....	8
OASIS Models.....	9
Difference Between Elite & Core.....	13
Data Management & Reporting.....	14
Output to SPC Software.....	15
OASIS Offline Software.....	16
Measurement Capabilities.....	18
Available Options for OASIS.....	21



Why Use the OASIS to Measure Your Parts?

Because Measuring Parts Conventionally...

- **Takes too long**
A part with many dimensions can take up to 15 minutes to measure and record all data
- **Measurements vary depending on the user**
Variation in results between users due to many factors, including part placement and focus (comparator) and operator skill level/experience
- **Are difficult to use**
Long training times and learning curves mean you have to use your more highly skilled personnel for tasks that should be repetitive and potentially automated
- **Has limitations**
Require manual Data Collection, again bringing in the potential for human error

Measuring Parts with the OASIS Inspection System:

- **Speed**
Fast? How about a second! All dimensions are measured and displayed simultaneously – up to 99 dimensions at once! 15 minutes worth of work in a second. The OASIS is faster because we don't scan parts (which invites variable resolution) – the OASIS measures continuously.
- **Accurate**
Up to +/- .0001" on Elite and Core model, up to +/- .0002" on the CoreX2. More accurate because parts are measured the same way every time. No operator variation.
- **Easy**
Easy set-up of part programs mean a fast learning curve – everyone on the shop floor and in the QC Lab can use the OASIS, not just one or two people. If you can use a mouse, you can use the OASIS.
- **Measure On**
Data is collected with the click of a mouse. Every part, every measurement collected into a report that can be printed, turned into a spreadsheet or exported to your SPC software in real-time!



How Does it Work?

Step 1. Place the part

Name	Meas'd	LSL	Status	USL
01-DIA		0.5450		0.5550
02-DIA		0.7150		0.7250
03-DIA		0.5300		0.5400
04-DIA		0.5300		0.5400
05-DIA	0.1462	0.5300		0.5400
06-DIA		0.5300		0.5400
07-DIA		0.4850		0.4950
08-DIA	0.0026	0.4850		0.4950
09-DIA		0.4850		0.4950
10-DIA		0.4850		0.4950
11-DIA		0.5150		0.5250
12-DIST		0.1050		0.3050
13-DIST		0.1850		0.1950
14-DIST		0.1850		0.1950
15-DIST		0.1850		0.1950
17-DIST	1.1062	1.1150		1.1250
18-DIST		1.5400		1.5500
19-DIST		0.4050		0.4150
20-DIST		0.2300		0.2400
21-DIST		0.1350		0.1450
22-ANG		14.00°		18.00°
23-ANG		14.00°		18.00°
24-ANG		14.00°		18.00°
25-ANG		14.00°		18.00°
26-ANG		14.00°		18.00°
27-CR		0.6150		0.6250

Step 2. You're done!

Name	Meas'd	LSL	Status	USL
01-DIA	0.5488	0.5450		0.5550
02-DIA	0.7180	0.7150		0.7250
03-DIA	0.5347	0.5300		0.5400
04-DIA	0.5350	0.5300		0.5400
05-DIA	0.5353	0.5300		0.5400
06-DIA	0.5358	0.5300		0.5400
07-DIA	0.4919	0.4850		0.4950
08-DIA	0.4908	0.4850		0.4950
09-DIA	0.4906	0.4850		0.4950
10-DIA	0.4895	0.4850		0.4950
11-DIA	0.5205	0.5150		0.5250
12-DIST	0.2140	0.1050		0.3050
13-DIST	0.1907	0.1850		0.1950
14-DIST	0.1891	0.1850		0.1950
15-DIST	0.1922	0.1850		0.1950
17-DIST	1.1165	1.1150		1.1250
18-DIST	1.5429	1.5400		1.5500
19-DIST	0.4087	0.4050		0.4150
20-DIST	0.2359	0.2300		0.2400
21-DIST	0.1424	0.1350		0.1450
22-ANG	15.19°	14.00°		18.00°
23-ANG	14.91°	14.00°		18.00°
24-ANG	15.26°	14.00°		18.00°
25-ANG	15.10°	14.00°		18.00°
26-ANG	14.43°	14.00°		18.00°
27-CR	0.6219	0.6150		0.6250



If you can use a mouse, you can use the OASIS.

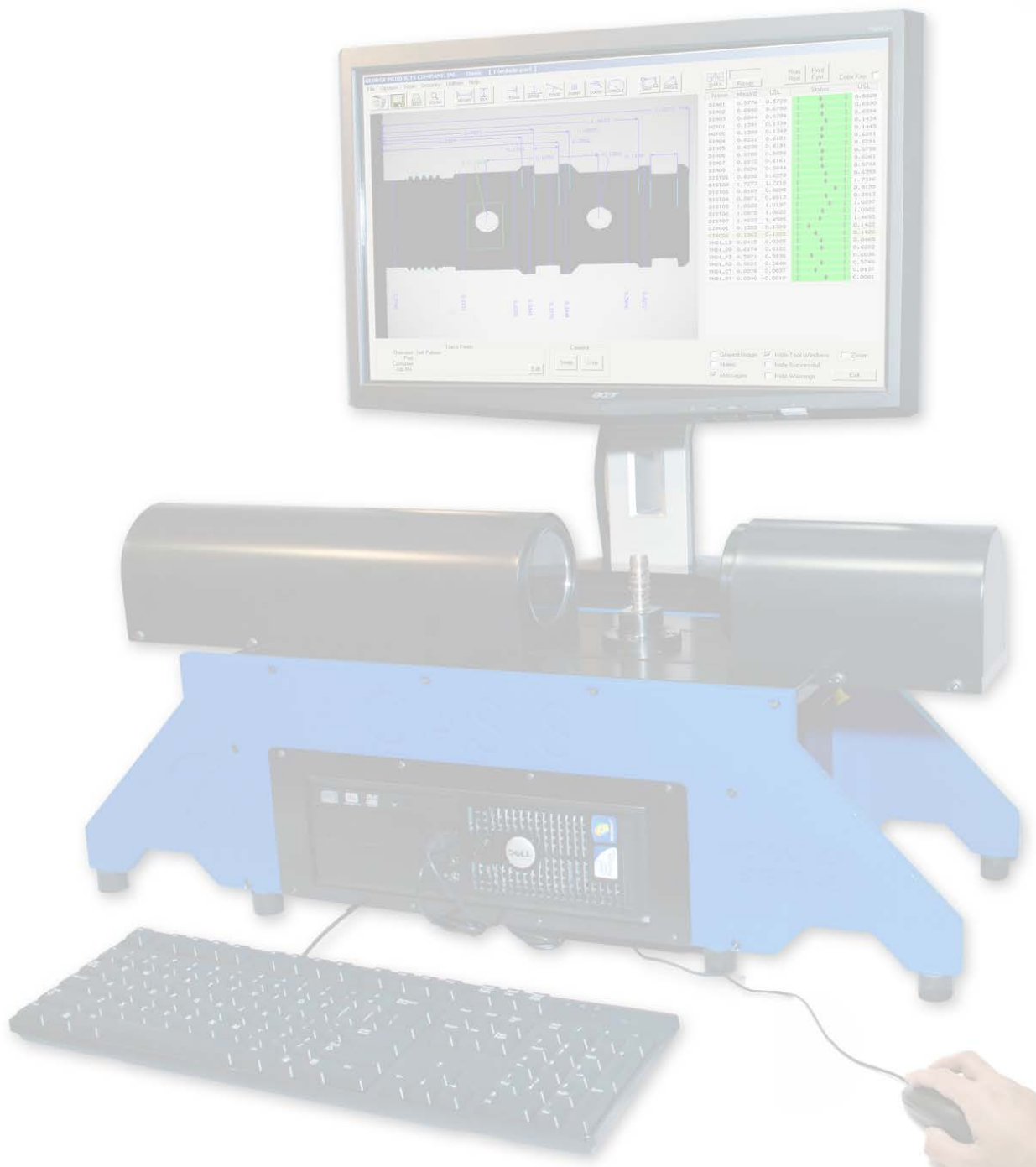



Part Programs in the OASIS

Set-up with a few mouse clicks and completed in minutes

To create a diameter measurement, click on the DIA Tool, hold the left mouse button down and drag across the location of the diameter. Instantly, the diameter measurement is displayed.

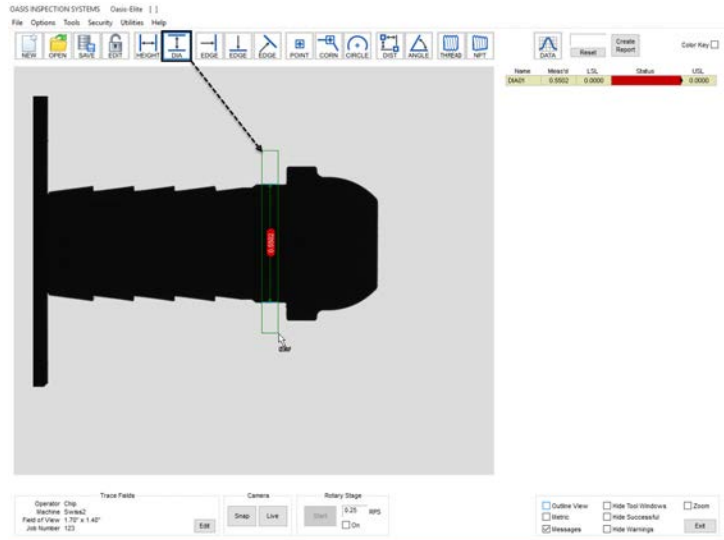

Now right-click the mouse and choose Tolerances.

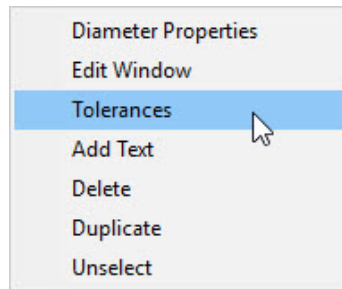

1. Enter the nominal value
2. Enter the +/- value
3. Enter percentage for warning limit (optional)

That's all there is to it, you're ready to setup the next dimension

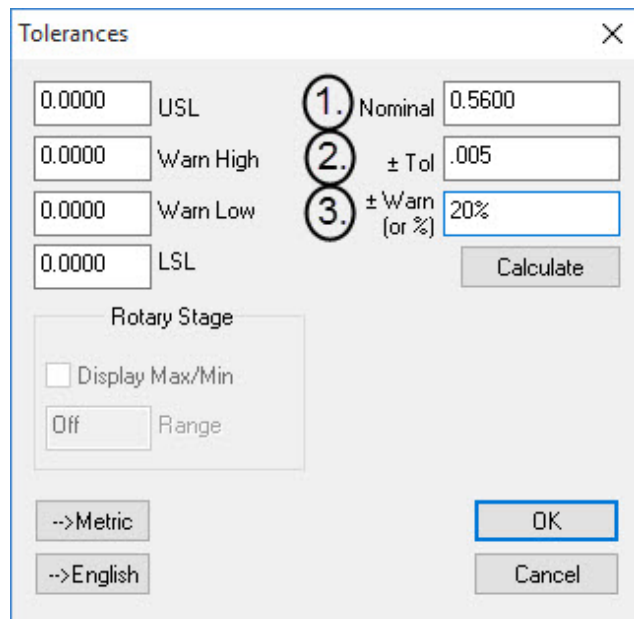



Open programs using Search Feature

The OASIS can automatically recognize your part and open the program for you. A Barcode Scanner can also be used to open programs instantly.

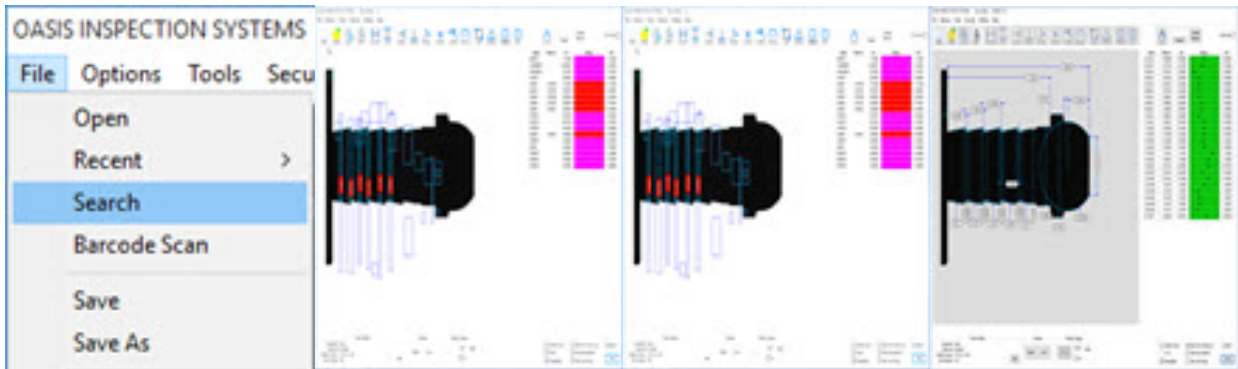

Edge Tracking feature for recognition of part position

With the Edge Tracking feature in the OASIS, the part does not have to be in the same location every time – if the OASIS can see the edges of the part, it can find and measure it. No need to slow down your inspections trying to fixture the part, just place it.

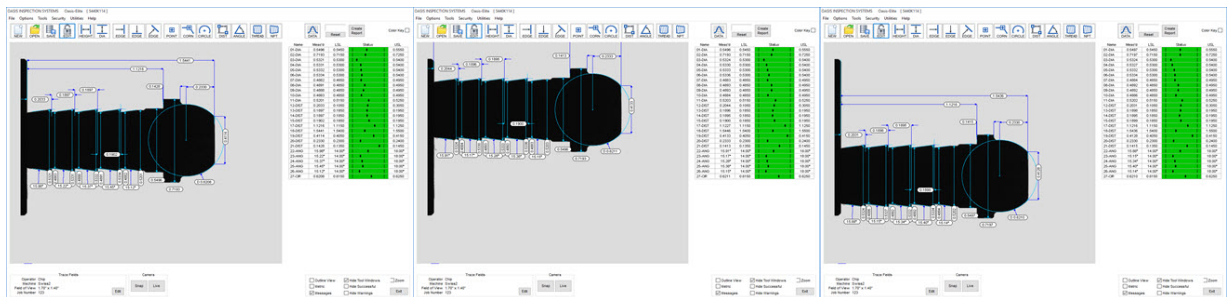

Measure up to 99 dimensions instantly and simultaneously

All measurements are taken instantly. The OASIS measures continuously so there is no need to wait; all dimensions are displayed as soon as the part is placed – up to 99 in a single operation.



Reduce inspector influence and error

Because the software, camera and light-source are doing all of the work, operator influence and chance for error is eliminated. The same feature on the same part will give you the same dimension, regardless of who the inspector is, or what their skill level is.

Automatic focus

There is no operator influence on the focus of the OASIS; focus is automatic across the entire depth of field. Parts are always at the optimum focal point.

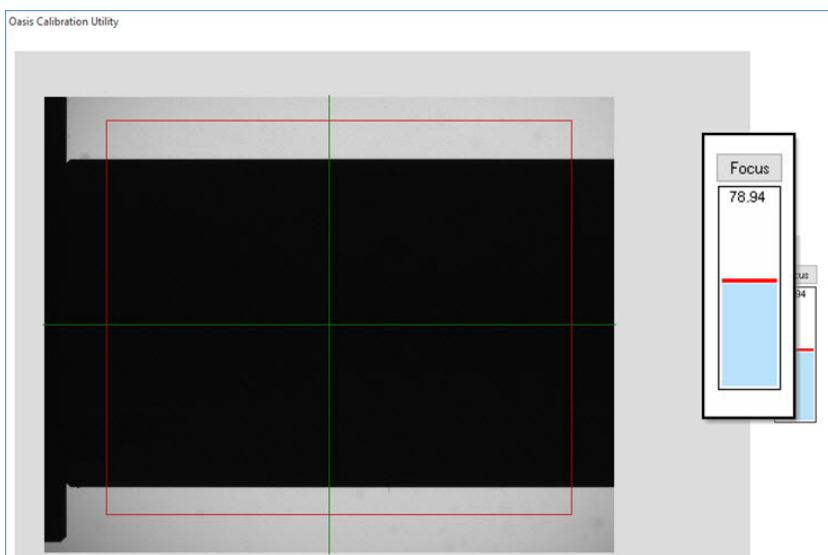

Automatic light settings

The lamp level is set at the factory and requires no operator input. This light source has an anticipated life-span of 50,000 continuous hours of use.

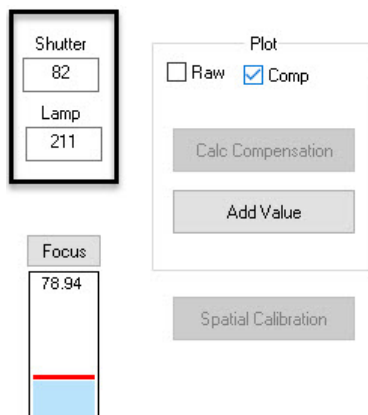



OASIS Models

Elite Model – available in two Fields of View

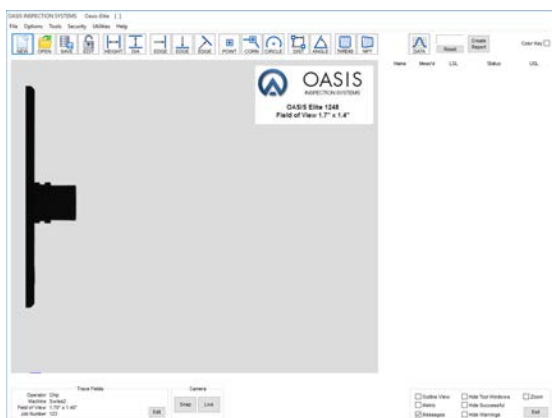

Elite 12048
Field of View 1.70" x 1.40"

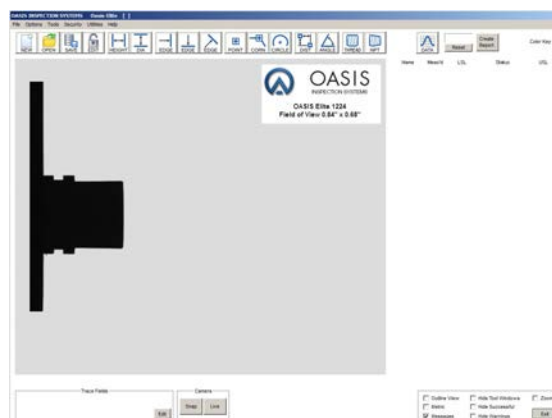

Elite 12024
Field of View 0.84" x 0.68"

- Accurate up to +/- .0001"
- Tilts up to 90 Degrees for use with optional 90 Degree Glass Stage for measuring flat parts
- 30" x 17" x 12" footprint – weighs 78 lbs
- Includes computer, monitor, mouse & keyboard – everything you need to measure parts right out of the crate



OASIS Models

Elite Dual Model – two Fields of View - one machine!

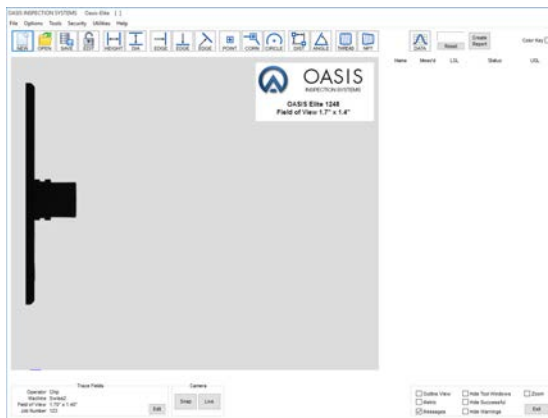

Elite 12048
Field of View 1.70" x 1.40"

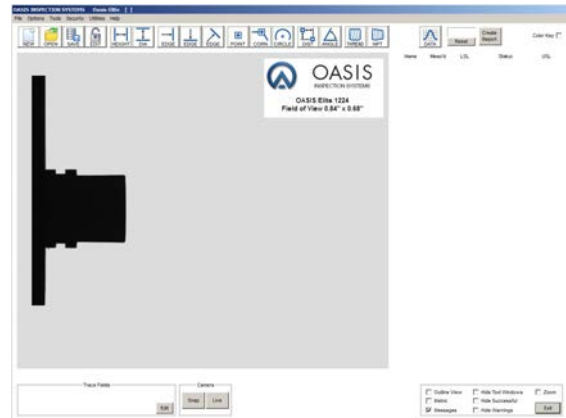

Elite 12024
Field of View 0.84" x 0.68"

- Accurate up to +/- .0001"
- Both sides tilt up to 90 Degrees for use with optional 90 Degree Glass Stage for measuring flat parts
- 30" x 17" x 12" footprint – weighs 110 lbs
- Includes computer, monitor, mouse & keyboard – everything you need to measure parts right out of the crate
- Softwares operate independently (not simultaneously)



OASIS Models

CoreX2 – our largest Field of View



CoreX2
Field of View 3.25" x 2.60"

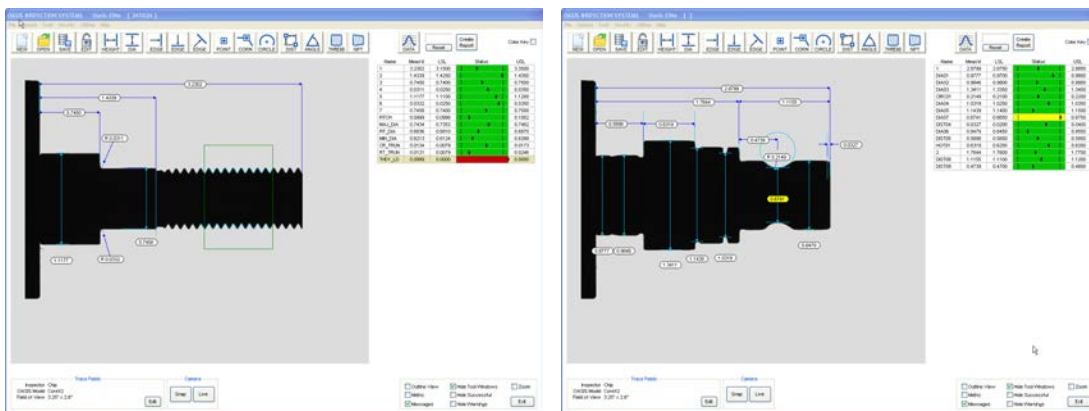

- Accurate up to +/- .0002"
- 46" x 12 ½" x 9" footprint – weighs 78 lbs
- Includes computer, monitor, mouse & keyboard – everything you need to measure parts right out of the crate
- Measure longer parts with our File-Linking feature (available on all models)



OASIS Models

Core – our most economical system

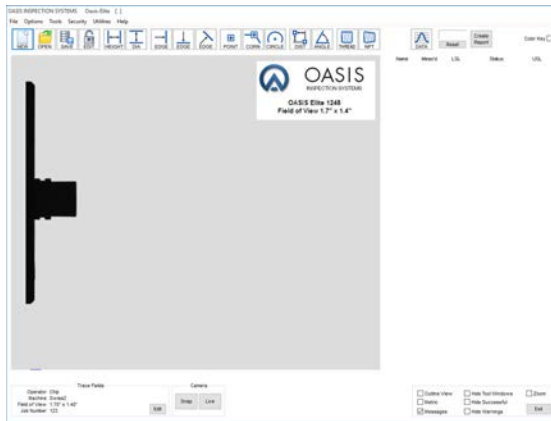
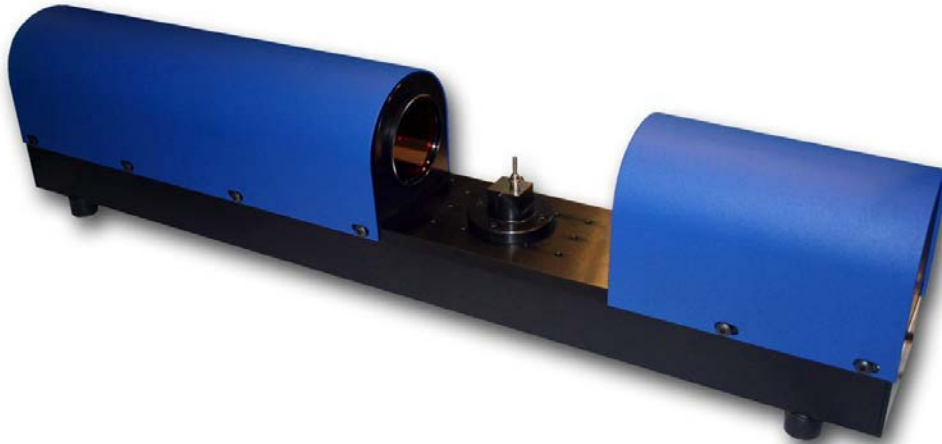

Core 12048
Field of View 1.70" x 1.40"

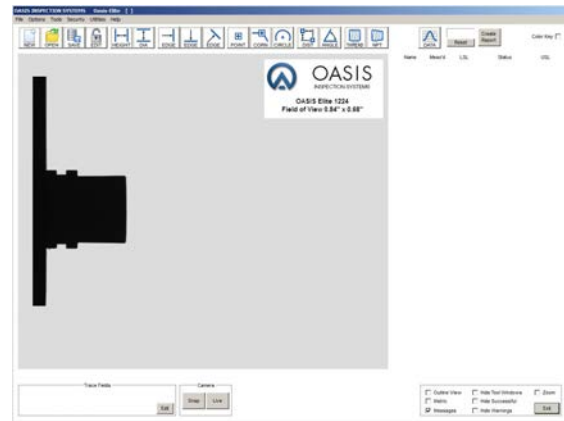

Core 12024
Field of View 0.84" x 0.68"

- Accurate up to +/- .0001"
- Available with OASIS Lite software version (see next page)
- 30" x 5" x 7" footprint – weighs 32 lbs
- Includes computer, monitor, mouse & keyboard – everything you need to measure parts right out of the crate



Differences between the OASIS Elite and Core

There are three main differences between the OASIS Elite and the OASIS Core.

Footprint and weight

- The OASIS Elite has a footprint of 30”x 17”x 12” and weighs 78 lbs. and the OASIS Core has a footprint of 30”x 5”x 7” and weighs 32 lbs., making the Core light-weight table-top version of the Elite.

Tilt feature for measurement of flat parts

- The OASIS Elite has a base that can tilt up to 90 degrees for use with our optional 90 Degree Glass Stage for measurement of flat parts. The OASIS Core does not have that capability.

Lite software version available with Core

- The OASIS Core is the only unit we offer with the Lite version of our software. This is an economical alternative for manufacturers whose measurement needs are basic.

OASIS-Lite Tools Menu:	OASIS-Full Tools Menu:	OASIS-Full Tools Menu with Premium Software Add-On:
Available for Core unit only	Standard Tools Menu with Elite, CoreX2 and Core-Full	Menu with Premium Tools added

**Note – Rotary Stage Tool is activated when Motorized Rotary Stage is present*

**Note – For Premium Tools to be added, the Full software version must be present*



OASIS Data Management, Reporting and Output

Easy Data Collection

Data is collected in the OASIS by pressing the Data key with the mouse or the 'D' key on the keyboard after each part. This data is automatically stored in a file with the same the inspection program and can be appended any time until the file is deleted.

```

START|C:\gpc\Oasis\Data\5440K114.txt
TRACE|Operator|Chip
TRACE|Machine|Swiss1
TRACE|Field of View|1.70" x 1.40"
TRACE|Job Number|123
DATA|01-DIA|0.5450|0.5460|0.5478|0.5540|0.5550|PASS
DATA|02-DIA|0.7150|0.7160|0.7195|0.7240|0.7250|PASS
DATA|03-DIA|0.5300|0.5310|0.5353|0.5390|0.5400|PASS

```

OASIS Report

The OASIS comes with on-board reporting software that takes the collected data and compiles it into a report. The report has a customizable header and can include an outline view of the part, the part print or even a picture of the part. The report can be printed in its entirety or the Data Summary only. The summary shows the MIN MAX and AVG dimension of each feature across the entire lot of parts.

Dimension	Low Limit	Low Warn	Measured	High Warn	High Limit	Status	Dimension Notes
01-DIA	0.5450	0.5460	0.5478	0.5540	0.5550	+	
02-DIA	0.7150	0.7160	0.7195	0.7240	0.7250	+	
03-DIA	0.5300	0.5310	0.5353	0.5390	0.5400	+	
04-DIA	0.5300	0.5310	0.5361	0.5390	0.5400	+	
05-DIA	0.5300	0.5310	0.5367	0.5390	0.5400	+	
06-DIA	0.5300	0.5310	0.5372	0.5390	0.5400	+	
07-DIA	0.4850	0.4860	0.4915	0.4940	0.4950	+	
08-DIA	0.4850	0.4860	0.4927	0.4940	0.4950	+	
09-DIA	0.4850	0.4860	0.4924	0.4940	0.4950	+	
10-DIA	0.4850	0.4860	0.4919	0.4940	0.4950	+	
11-DIA	0.5150	0.5160	0.5190	0.5240	0.5250	+	
12-DIST	0.1950	0.1950	0.2069	0.2050	0.2050	-	
13-DIST	0.1850	0.1860	0.1895	0.1940	0.1950	+	
14-DIST	0.1850	0.1860	0.1895	0.1940	0.1950	+	
15-DIST	0.1850	0.1860	0.1901	0.1940	0.1950	+	
16-DIST	1.1150	1.1160	1.1235	1.1240	1.1250	+	
18-DIST	1.5400	1.5410	1.5474	1.5490	1.5500	+	
19-DIST	0.4950	0.4960	0.4910	0.4940	0.4950	-	
20-DIST	0.2300	0.2310	0.2330	0.2390	0.2400	+	
24-DIST	0.2300	0.2310	0.2330	0.2390	0.2400	+	

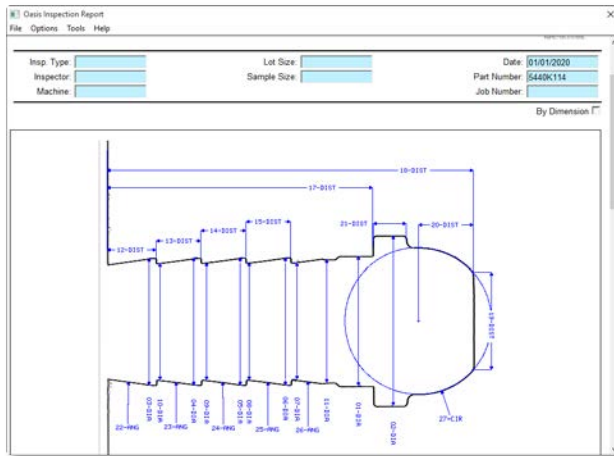



Other output options

Send Data to SPC

The OASIS text file can be output in real-time to SPC software. In most cases, making OASIS and your SPC software ‘talk’ is as simple as naming the data acquisition source the same as the OASIS data folder. When the Data button is pressed on OASIS, the dimensions are plotted in your SPC software.

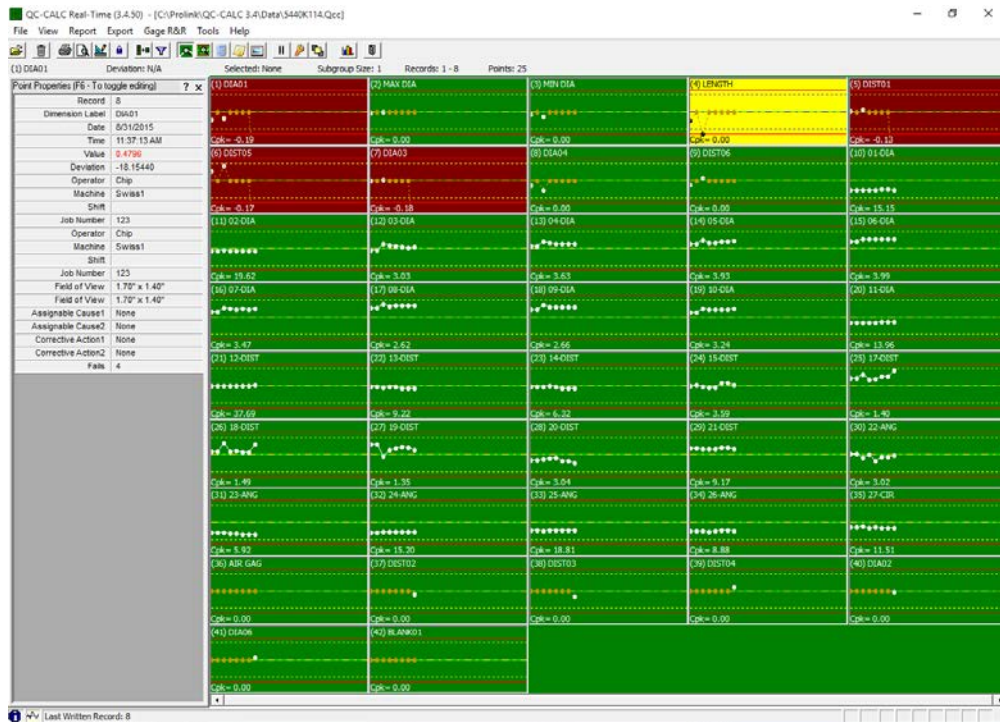

*Prolink Software QC-Calc shown

Create a Spreadsheet with the press of a button

The OASIS Report can be changed to a CSV file for viewing as a spreadsheet by simply pressing Create CSV File in the report – nothing extra to buy, this is part of the report’s capability.

A	B	C	D	E	F	G	H	I	J	K	L	M	N	O	P	Q	R
Dimension	01-DIA	02-DIA	03-DIA	04-DIA	05-DIA	06-DIA	07-DIA	08-DIA	09-DIA	10-DIA	11-DIA	12-DIST	13-DIST	14-DIST	15-DIST	17-DIST	18-DIST
High Limit	0.555	0.725	0.54	0.54	0.54	0.54	0.495	0.495	0.495	0.495	0.525	0.305	0.195	0.195	0.195	1.125	1
Low Limit	0.545	0.715	0.53	0.53	0.53	0.53	0.485	0.485	0.485	0.485	0.515	0.105	0.185	0.185	0.185	1.115	1
1	0.5478	0.7197	0.5359	0.5363	0.5368	0.5373	0.4921	0.4928	0.4926	0.4918	0.5187	0.2064	0.1895	0.1898	0.1898	1.1228	1.54
2	0.5477	0.7197	0.5355	0.5363	0.5368	0.5373	0.492	0.4928	0.4926	0.4918	0.5187	0.2064	0.1895	0.1897	0.1899	1.1228	1.54
3	0.5478	0.7197	0.5355	0.5363	0.5368	0.5373	0.492	0.4928	0.4926	0.4918	0.5187	0.2064	0.1895	0.1898	0.1899	1.1228	1.54
4	0.5478	0.7197	0.5355	0.5363	0.5368	0.5373	0.492	0.4928	0.4926	0.4918	0.5187	0.2064	0.1895	0.1898	0.1899	1.1228	1.54
5	0.5478	0.7197	0.5354	0.5363	0.5368	0.5373	0.492	0.4928	0.4925	0.4918	0.5187	0.2064	0.1895	0.1898	0.1898	1.1228	1.54
6	0.5478	0.7197	0.5354	0.5363	0.5368	0.5373	0.492	0.4928	0.4925	0.4918	0.5187	0.2064	0.1895	0.1898	0.1898	1.1228	1.54
7	0.5478	0.7197	0.5354	0.5363	0.5368	0.5373	0.492	0.4928	0.4925	0.4918	0.5187	0.2064	0.1895	0.1898	0.1898	1.1228	1.54
8	0.5478	0.7197	0.5354	0.5363	0.5368	0.5373	0.492	0.4928	0.4925	0.4918	0.5187	0.2064	0.1895	0.1898	0.1898	1.1228	1.54
9	0.5478	0.7197	0.5354	0.5363	0.5368	0.5373	0.492	0.4928	0.4925	0.4918	0.5187	0.2064	0.1895	0.1898	0.1898	1.1228	1.54
10	0.5478	0.7197	0.5354	0.5363	0.5368	0.5373	0.492	0.4928	0.4925	0.4918	0.5187	0.2064	0.1895	0.1898	0.1898	1.1228	1.54
11	0.5478	0.7197	0.5354	0.5363	0.5368	0.5373	0.492	0.4928	0.4925	0.4918	0.5187	0.2064	0.1895	0.1898	0.1898	1.1228	1.54
12	0.5478	0.7197	0.5354	0.5363	0.5368	0.5373	0.492	0.4928	0.4925	0.4918	0.5187	0.2064	0.1895	0.1898	0.1898	1.1228	1.54



OASIS Offline Software for remote setup of part programs

With the purchase of the OASIS you receive the Offline version of our software for even faster part program setup. Programs are created without taking up valuable time on the machine.

Completed part programs can be saved to a memory device for installation on the OASIS or can be saved to a network to be accessed by the operator. The software can be installed to as many PCs as needed, there are no licenses or seat fees to pay for this – it is free for the life of the machine.

The Offline software works by using an image of the part from the live OASIS. When the image of the part is opened in the Offline software, tool windows can be placed for all dimensions and tolerances setup. It's as if the part is right there on the screen, making programming fast and easy.

Save the part image from the 'live' OASIS

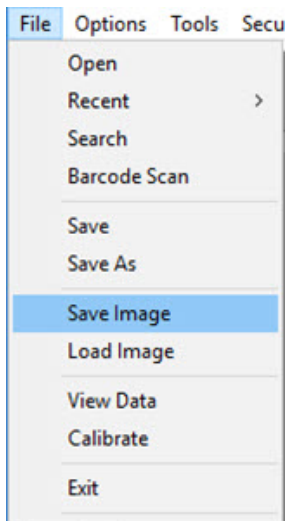

Load the part image to the 'remote' PC

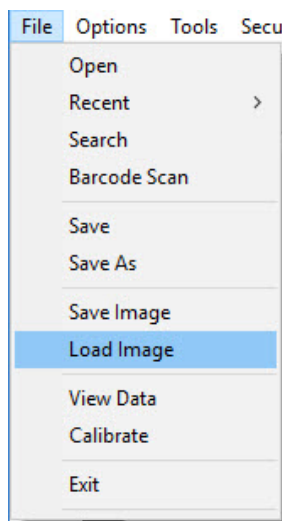

Now program your part just like you would on the live machine.

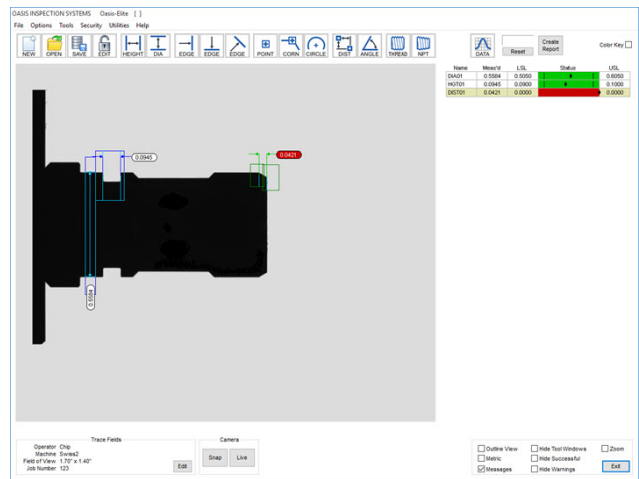



OASIS Measurement capabilities

In addition to measurements such as Lengths, Diameters, Angles and Radii, OASIS software includes the following measurement capabilities:

Taper Tool:

The Taper Tool measures the Maximum and Minimum diameter over a given length. If the length is bound, it also measures the length of the bounded range and checks that the chamfers (or fillets) meet specific tolerances.

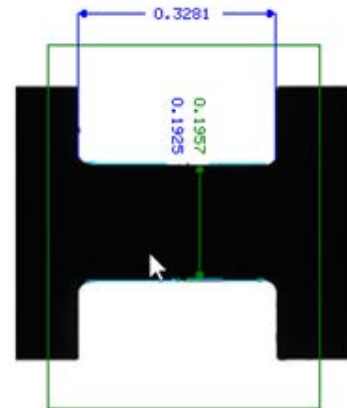

Gage Line Tool:

The Gage Line Tool instantly finds the distance to a specified diameter. In this case the diameter is the known value and the distance is the unknown value.

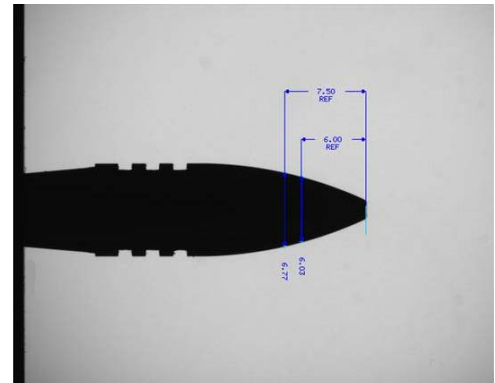

Offset Diameter Tool:

The Offset Diameter Tool instantly finds a diameter at a specified distance from a reference edge. In this case the distance is the known value and the diameter is the unknown value.

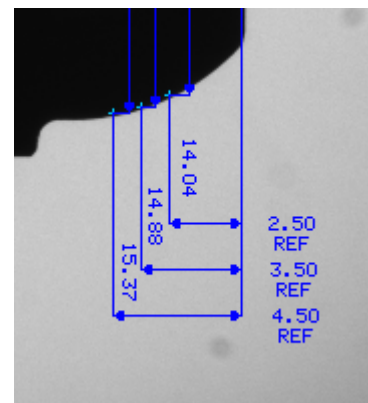



Pitch Tool:

The Pitch Tool can report either Pitch (distance between pattern repeats) or Count (number of patterns per unit distance). Example, number of Threads per Inch

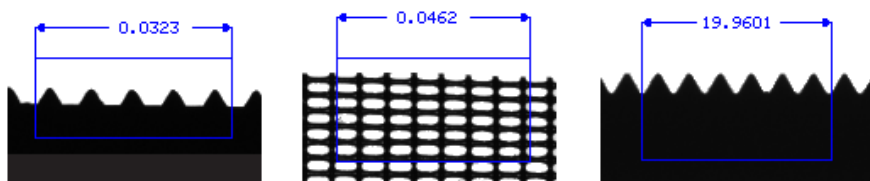

Link-File Tool

The Link-File Tool can be used to execute two or more part programs in automatic sequence and have the data saved in a common file. This is useful for parts that are too long for the Field of View or if a part is to be measured in more than one position.

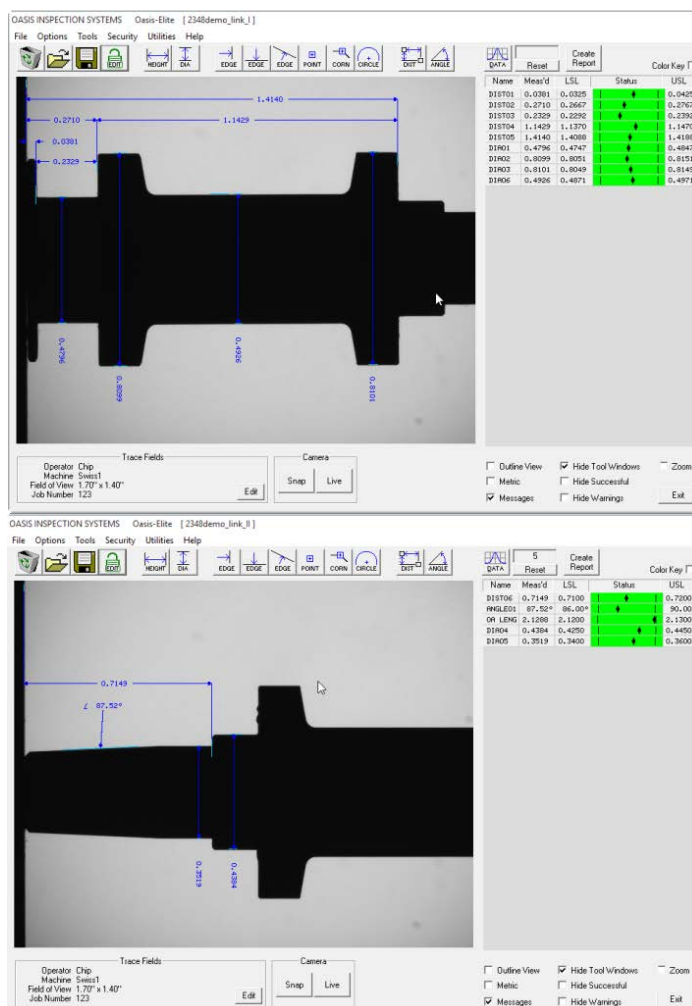



Blank Tool

The Blank Tool can be used as a Place Keeper for Measurements made external to the Oasis. This tool performs no measurement, but provides a mechanism to include a blank line in the data output stream, which can be populated afterwards.

19-DIST	0.4108	0.4050		0.4150
20-DIST	0.2329	0.2300		0.2400
21-DIST	0.1413	0.1350		0.1450
22-ANG	15.92°	14.00°		18.00°
23-ANG	14.92°	14.00°		18.00°
24-ANG	15.12°	14.00°		18.00°
25-ANG	15.31°	14.00°		18.00°
26-ANG	15.22°	14.00°		18.00°
27-CIR	0.6186	0.6150		0.6250
BLANK01		0.4980		0.5020

19-DIST	0.4050	0.4060	0.4110	0.4140	0.4150	
20-DIST	0.2300	0.2310	0.2330	0.2390	0.2400	
21-DIST	0.1350	0.1360	0.1413	0.1440	0.1450	
22-ANG	14.00	14.40	15.90	17.60	18.00	
23-ANG	14.00	14.40	14.92	17.60	18.00	
24-ANG	14.00	14.40	15.12	17.60	18.00	
25-ANG	14.00	14.40	15.31	17.60	18.00	
26-ANG	14.00	14.40	15.21	17.60	18.00	
27-CIR	0.6150	0.6160	0.6188	0.6240	0.6250	
BLANK01	0.4980	0.4984		0.5016	0.5020	

Part No. 1 Aug 31 2015 11:37:13 AM C:\gpc\Oasis\Data\5440K114.txt

Messages Tool

Customized pop-up messages can be issued when a program opens or after the Data Button is clicked. Messages are especially useful when used in conjunction with Linked Files, as they can prompt and instruct the operator on how to set up the part for various sections of a linked sequence

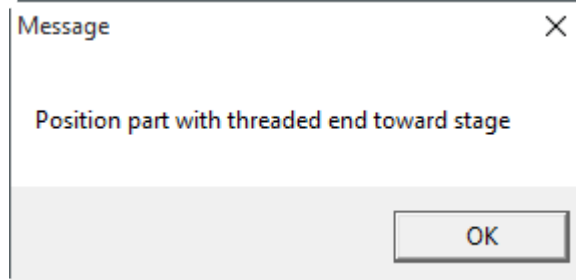

Ring & Gear Tools

When used with our optional 90 Degree Glass Stage the Ring & Gear Tools measures multiple diameters on a ring or gear. For proper operation, the entire outside and inside areas of the part must be visible.

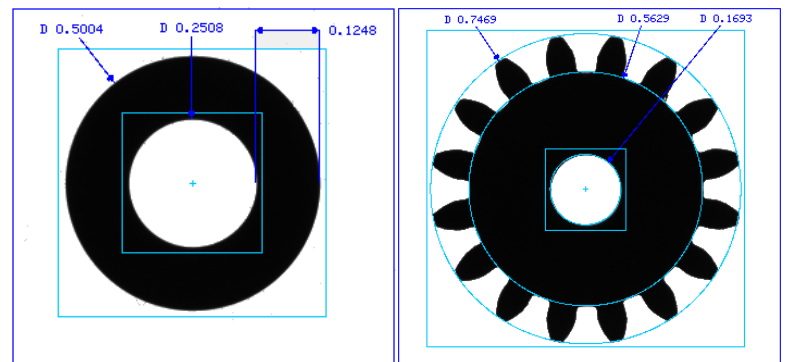



Available Options for the OASIS

OASIS Premium Software Add-On Module:

Unified/ISO Threads

The Unified/ISO Thread Tool (Thread Tool) measures multiple features on a thread. The Thread Tool measures threads with Horizontal (Fig. 1) or Vertical centerlines.

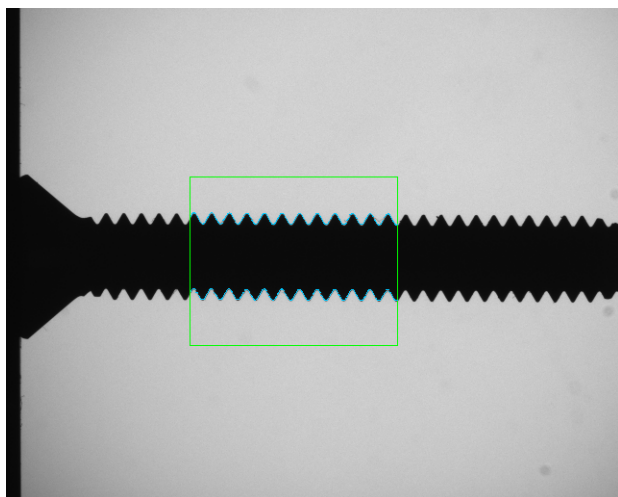

THD0_LD	0.0501	0.0498		◆		0.0502
THD0_OD	0.2464	0.2408		◆		0.2489
THD0_PD	0.2131	0.2127	◆			0.2164
THD0_RD	0.1831	0.1802	◆			0.1948
THD0_CT	0.0050	0.0036		◆		0.0095
THD0_RT	0.0067	0.0036		◆		0.0127

LD – The Lead of the Thread
 OD – The Outside Diameter
 PD – The Pitch Diameter
 ID – The Inside Diameter
 CT – The Crest Truncation
 RT – The Root Truncation

NPT Threads

The NPT Thread Tool (Thread Tool) measures multiple features on a tapered thread. Currently this tool works for threads with Horizontal centerlines.

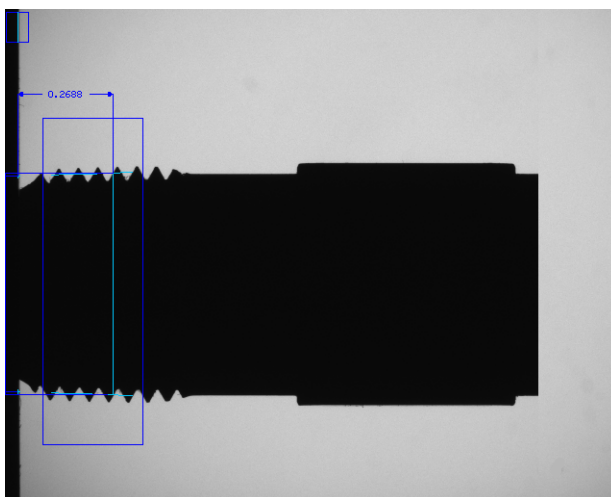

THD1_LD	0.0554	0.0543		◆		0.0568
THD1_TA	0.0711	0.0573			◆	0.0730
THD1_E0	0.6073	0.6054	◆			0.6164
THD1_L1	0.2766	0.1844			◆	0.2956
THD1_CT	0.0040	0.0018		◆		0.0049
THD1_RT	0.0038	0.0018		◆		0.0049

LD – The Lead of the Thread
 TA – The Taper of the Thread
 E0 – The Pitch Diameter at the end of the Thread
 L1 – The Distance from the end of the Thread to where the Pitch Diameter = E1
 CT – The Crest Truncation
 RT – The Root Truncation



OASIS Premium Software Add-On Module *(continued)*: **Construction Tool:**

The Construction Tools can be used to create Virtual Lines, Intersection Points, Circles and to find Tangent Points.

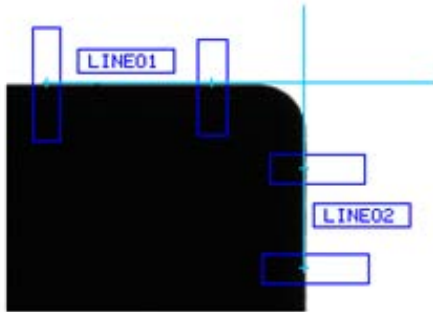

Lines through Edge Points

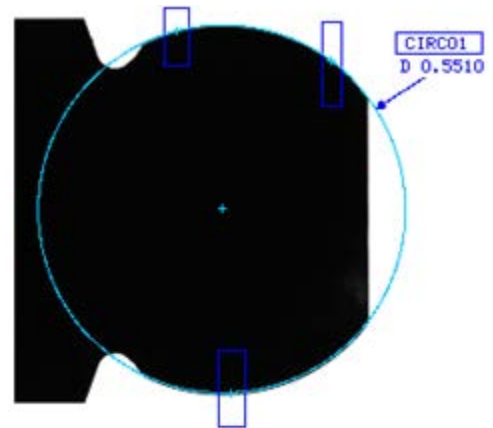

Circle through 3 Edge Points

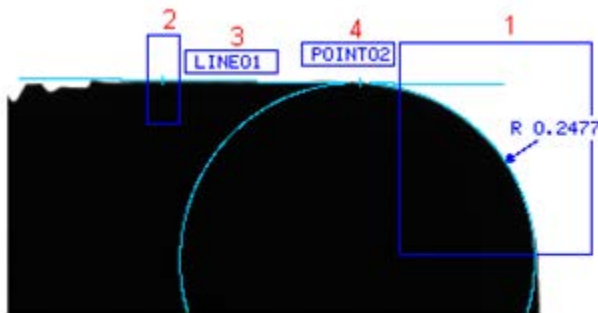

Tangent Point (POINT02) of Edge and Radius

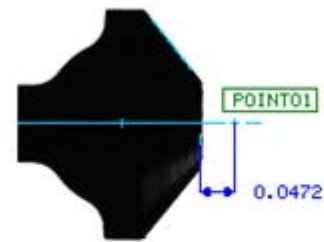

Intersection Point of Projected Edge and Centerline

Math Tool:

The Math Tool can be used to make calculations based on measurements made by tools or manually entered values.

Name	Meas'd	LSL	Status	USL
MAX DIA	0.4927	0.0000		0.0000
MIN DIA	0.4924	0.0000		0.0000
MATH01	0.0003	0.0000		0.0000

Math Tool Properties

MATH01 Name

Referenced

Argument 1	Oper	Argument 2
MAX DIA	-	MIN DIA

Absolute Value
 Partial Result

MAX DIA
MIN DIA
z \$REF1
z \$REF2
z \$REF3
z \$REF4



Available Options for the OASIS

In addition to the Premium Software Add-On Module, we offer the following optional accessories for your OASIS:

Manual Rotary Stages

All units have an available Manual Rotary Stage. The Manual Rotary Stages are for viewing parts from any position. This is useful for looking at roundness and concentricity as well as aligning hex flats and through-holes.

Manual Stage for Elite and Core Units



Manual Stage for CoreX2 Units

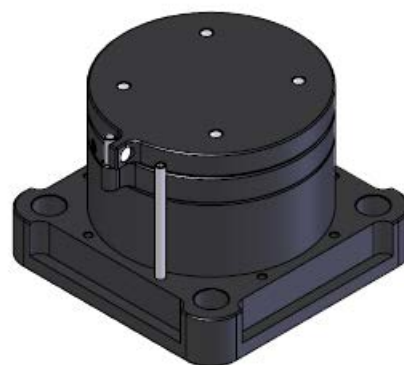
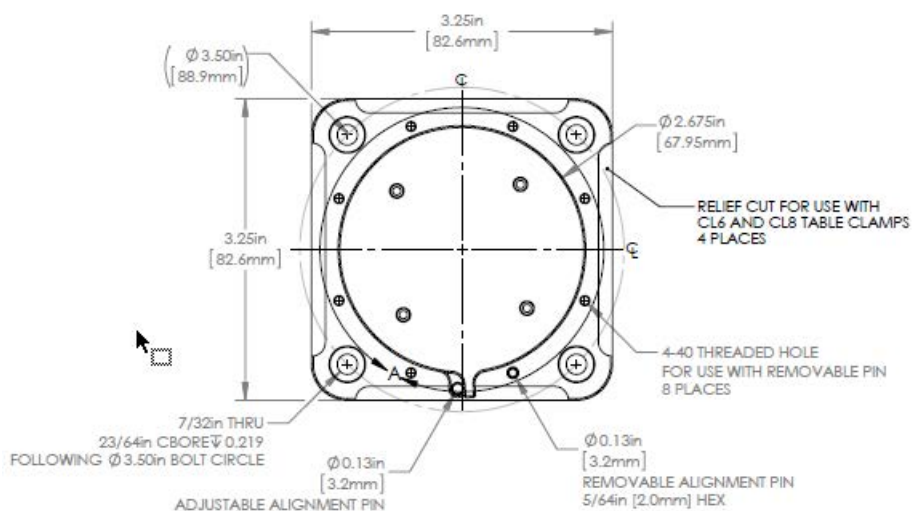



Motorized Rotary Stage for Virtual 360 Degree Measurement

The Elite 12048 Model has an available Motorized Rotary Stage for automated data collection. The user defines how many rotations for the Rotary Stage to make and how many times to measure the part while rotating. Setting the OASIS to measure 12 times in one rotation is like having 12 cameras measuring your part for virtual 3D measurement – great for checking roundness, runout and concentricity. Once the cycle is complete, the OASIS displays the Minimum, Average, Maximum, and Range for every dimension. A single click saves all of the data on the OASIS.



MAX-MIN	Range	Min	Status	Max
DIA01	0.0009	0.4518	◆◆◆	0.4527
DIA02	0.0008	0.4058	◆◆◆	0.4066
DIST01	0.0049	0.1880	◆◆	0.1929
DIST02	0.0028	0.3782	◆◆	0.3810
ANGLE01	0.14°	15.85°	◆	15.99°

90 Degree Glass Stage

OASIS Elite and Elite Dual units have a base that can be tilted up to 90 degrees for use with our optional 90 Degree Glass Stage. This provides a glass surface for measurement of flat parts such as rings, gears and others. The camera and the light-source remain perfectly aligned and measurement is just as fast and easy as it is with a standing part.

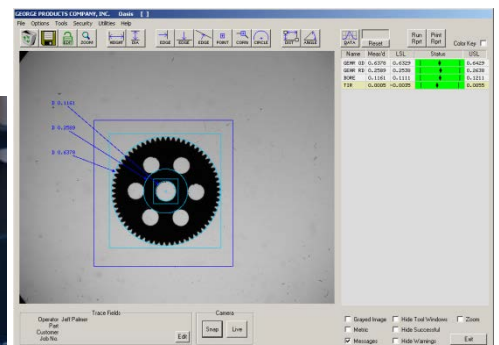



George Products Company, Inc.

Founded in 1951 in Livingston, NJ, George Products Company, Inc. owns and operates its 20,000 square-foot fabrication, assembly and testing facility in Middletown, Delaware, USA.

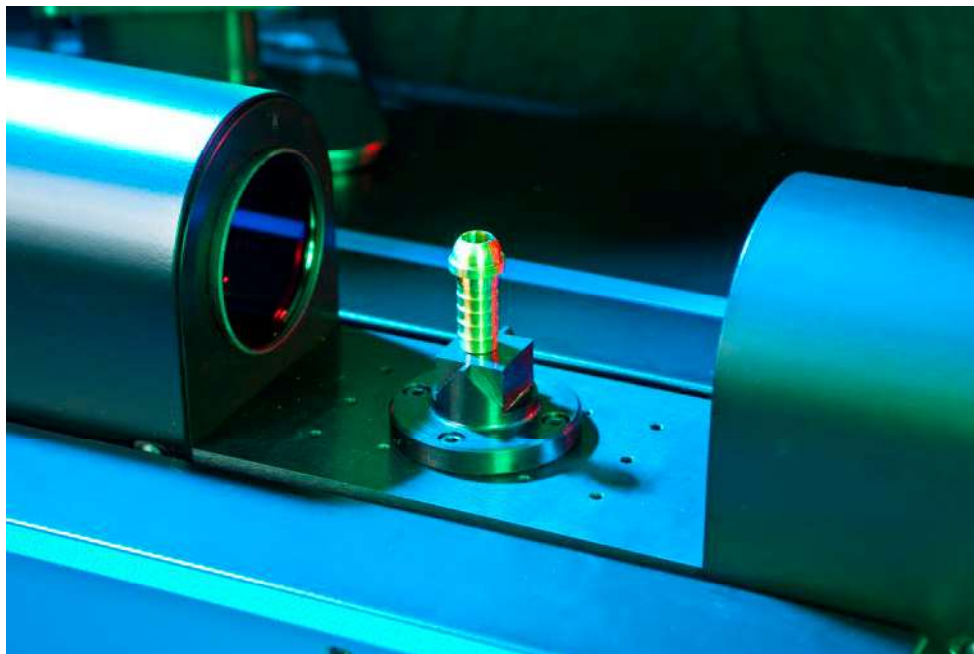

Model Shown: OASIS Elite15212048

Software Version 5.0

Created: 1/25/2016