



Solartron  
Metrology



**AMETEK**<sup>®</sup>  
ULTRA PRECISION TECHNOLOGIES

“Working with our customers and partners  
to provide complete precision linear  
measurement solutions”

“配合客户和合作伙伴提供完整的精密  
线性测量解决方案”

“Travailler avec nos clients et partenaires  
pour fournir des solutions de mesures  
linéaires précises et complètes”

“Zusammenarbeit mit Kunden und  
Partnern für die Bereitstellung präziser  
Messlösungen”

“Lavoriamo con i nostri clienti e partner per  
fornire soluzioni di misura lineare complete  
ed accurate”

“お客様へ高精度のリニア測定を実現す  
るためのソリューションを提供します。”

“Trabalhando com nossos clientes  
e parceiros para fornecer soluções  
precisas em medição linear”

“Сотрудничество с клиентами и  
партнерами обеспечивает наилучшие  
комплексные решения в области  
высокоточных систем линейных  
измерений.”

“Trabajamos con nuestros clientes y socios  
para proporcionarles soluciones completas  
en medidas lineares de precisión”



# Contents



**Orbit® Overview**  
Page 4 - 5



**Applications**  
Page 6 - 7



**Selecting a Sensor & Output**  
Page 8 - 11



**Standard Gauge Probes**  
Page 12 - 13  
Specs: Page 16



**Light Tip Force Probes**  
Page 14  
Specs: Page 16 - 17



**Compact Probes**  
Page 15  
Specs: Page 16 - 17



**Block & Flexure Gauges**  
Page 18 - 19  
Specs: Page 22 - 23



**Mini & Lever Probes**  
Page 20 - 21  
Specs: Page 23

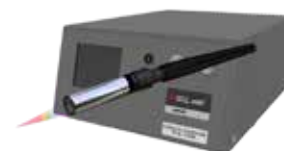

**Non-contact Confocal**  
Page 24  
Specs: Page 25 - 27

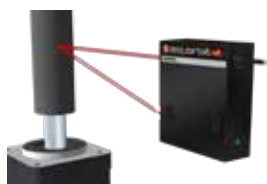

**Non-contact Laser**  
Page 28



**Wireless**  
Page 30



**Linear Encoder**  
Page 32



**Power Supply Modules & Accessories** - Page 33



**Special Input Modules**  
Page 34



**Interface Modules**  
Page 36 - 37



**Readouts**  
Page 38



**Probe Tips**  
Page 40 - 41

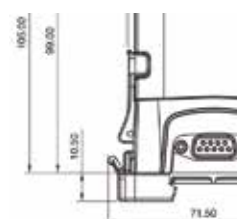

**Dimensions**  
Page 42 - 46

# Orbit® Digital Measuring Network

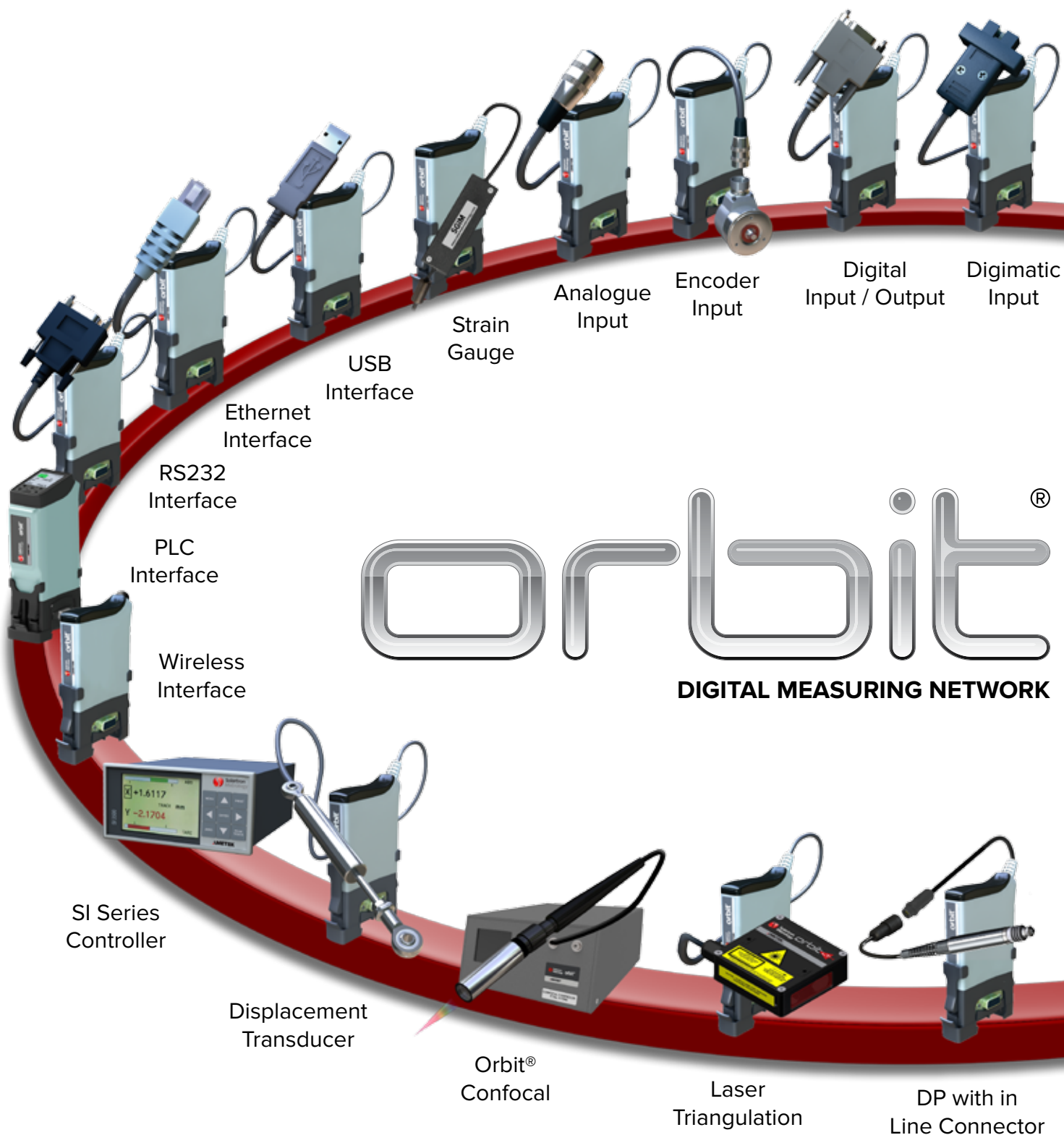

**orbit**®

**DIGITAL MEASURING NETWORK**

**CONTACT  
ENCODERS  
DIGITAL**

**NON  
CONTACT**

**GAUGING**

**DISTANCE**

**TECHNOLOGIES**

**MEASUREMENT  
AND CONTROL**

**PRECISION MECHANICAL  
ENGINEERING**

**TEMPERATURE  
Logic IO  
POSITION**

**DISPLACEMENT  
CURRENT  
STRAIN**

**LASERS  
ANALOGUE**

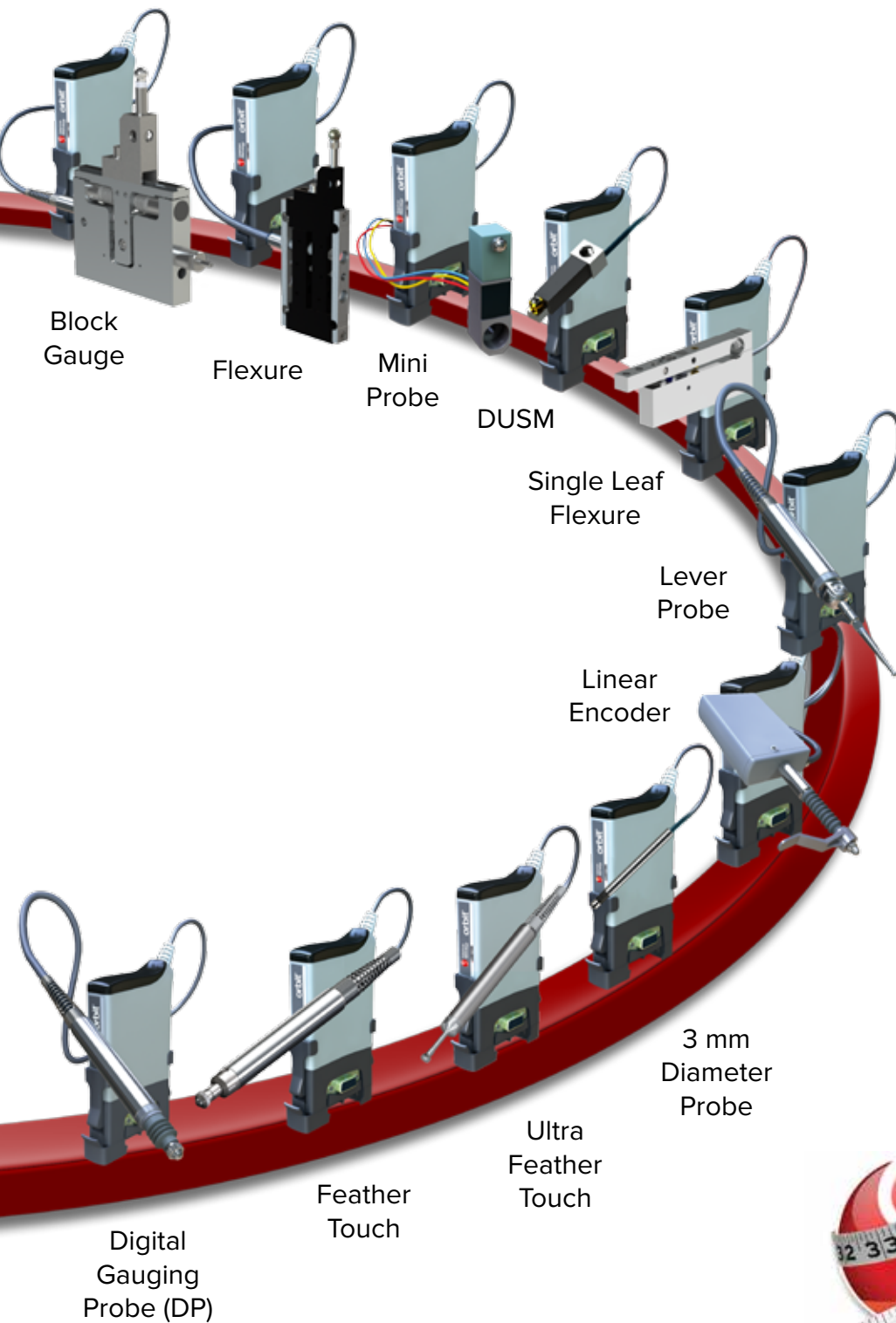

**Higher performance does not mean higher costs.**

Quality standards in industry and research are becoming tighter, while demands for cost savings continue to increase. Orbit® provides the way forward for all precision measurement or positioning needs, whether on the production line or in the laboratory.

Orbit® provides a complete solution for integrating different measurement position and control sensors smoothly and simply into network solutions.

The Orbit® system architecture consists of a rugged mechanical design coupled with a high degree of electrical protection and excellent noise immunity, ensuring valid accurate data when it is needed.

All Solartron products have undergone rigorous testing to ensure a long and productive life.



ETHERNET                      USB  
 COMPUTERS  
**INTEGRATING**  
 SENSORS                      PLCs  
 SERIAL                              WIRELESS

# Orbit® Applications

## Want to know a part's profile?

Combine Measuring Transducers with Rotary Encoders using the Encoder Interface Module to perform part profiling. Combine this with the high speed synchronised data capture modes of the Orbit® Measurement Network (Dynamic Modes) and you have full profile for products like Cam Shafts or indeed any product where the profile is of importance.

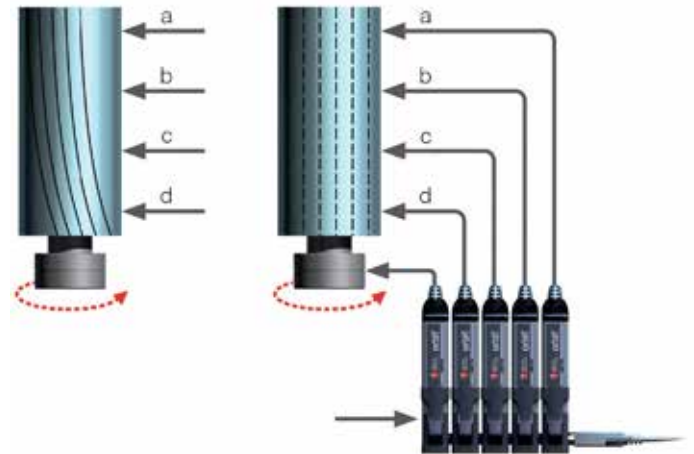

## Scared of damaging the part?

The low tip force options of contact transducers can solve your problems, or consider our non-contact products.

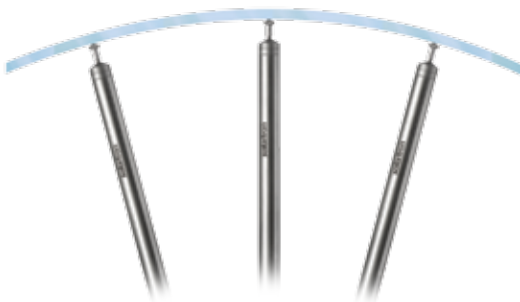

## Measure inside a Machine

With swarf chips and cutting oil present, measuring parts during the machining process is challenging – Contact Solartron for the latest sensors that can solve these problems.



## Check the part weight

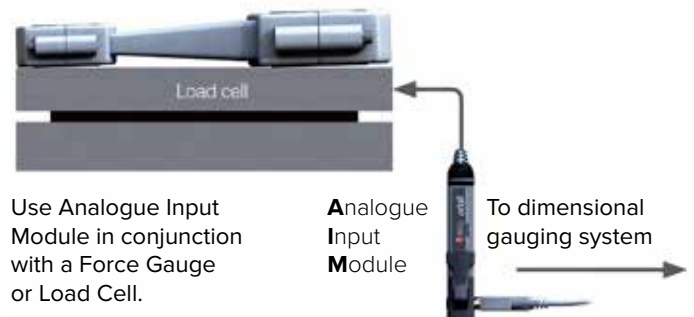

## Temperature a concern?

Use the Special temperature sensor version of the Analogue Input Module to check the part temperature or the ambient temperature either live with dimensional measurements or at the start and end of the measurement process.

## Process Monitoring

Use Contact probes or Confocal to monitor distances travelled, including the distance a screw is inserted into a metal sheet.

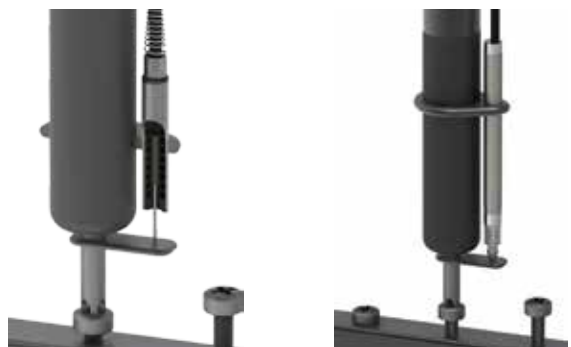

# Orbit® Applications

Connect and synchronise up to 150 Contact, Non-contact or 3rd party sensors per network.

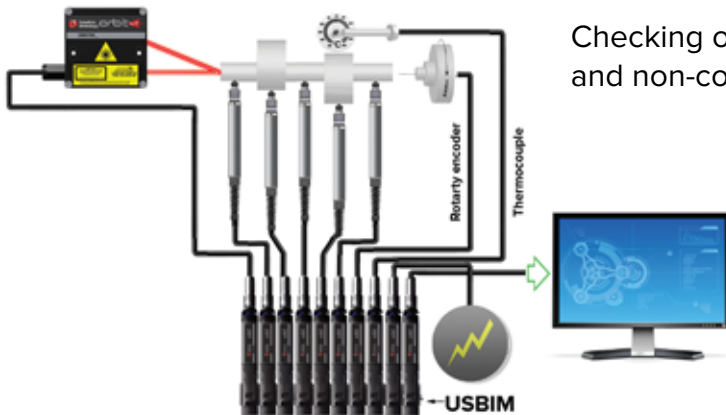

Checking of crank shaft using encoders, contact probes and non-contact lasers.

## Angles and Flatness

The precision measurement of angles requires high resolution + excellent linearity and repeatability.



## Automatic Gauging

Automatic gauging on-line or post-process is made possible with pneumatic probes and mechanical Interfaces.

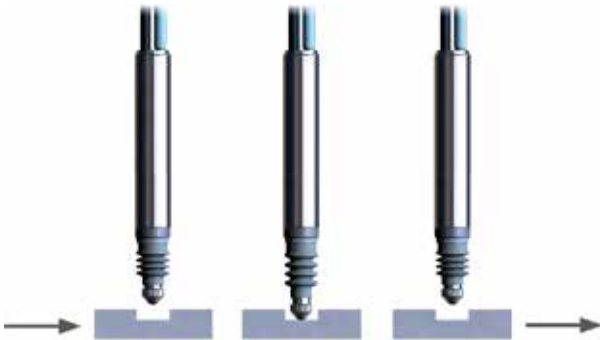

## Bearing Industry

Post process gauging or the grading of bearing components are among the most demanding of all post process gauging applications. Both Flexures and Block Gauges provide fast and reliable measurements in hard to reach places.

## Electronics Industry

Checking the components of a Hard Disk Drive



Checking Height of Semi Conductor Wafers

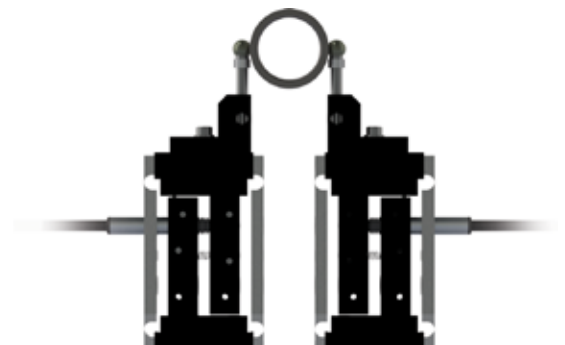
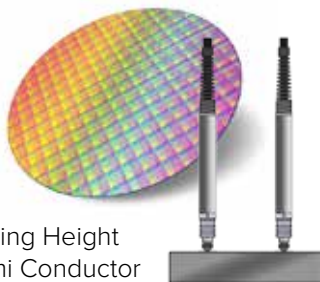

## Need some Visual Indication?

Connect a Digital Input Output Module to the Orbit® Measurement Network and use it to drive go and no go lamps.



# Select a Sensor for the Orbit® Network

Choose from a full array of linear measurement sensors, each with their own application advantages

## Contact Measurement

### Digital Probes and Transducers

- ▶ Accurate
- ▶ Repeatable
- ▶ Robust
- ▶ Small size
- ▶ Low tip force
- ▶ Long life
- ▶ Displaces light, dirt and oil
- ▶ Absolute measurement
- ▶ Works on all surfaces
- ▶ Best cost vs performance
- ▶ Can be used in most environments
- ▶ Very wide range of products



### “Feather Touch” Probes with Low Tip Force

- ▶ Tip forces from 20 g to as low as 3 g
- ▶ Ideal for glass, delicate surfaces, or easily damaged materials
- ▶ Nylon, Silicon Nitride and Ruby tips available
- ▶ Same high accuracy and resolution as digital probe



### Specialised Sensors

- ▶ Sensors for hard to reach areas, such as bores or gaps
- ▶ Multiple ranges and sizes
- ▶ Excellent resolution and repeatability
- ▶ Robust designs

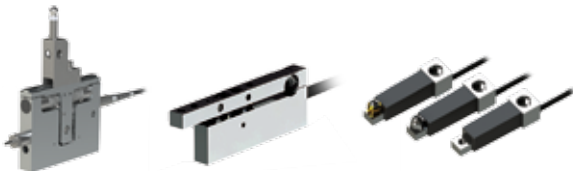

### Linear Encoder

- ▶ Glass Scale
- ▶ Best Accuracy over full scale range



## Custom Products

At Solartron Metrology our experienced design team have worked closely with customers to produce customised measurement solutions. If you require a specialised sensor to solve your measurement problem then please contact your local Solartron representative.



**Example:** Customised Feather Touch Probe

- ▶ Built for glass industry
- ▶ Long 30 mm travel, but with 5 mm range at end of stroke
- ▶ Ensures tip is clear when glass removed
- ▶ R/A Outlet with Steel Braided Cable



Automation



Metrology

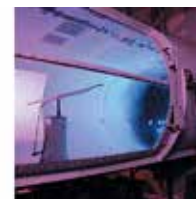

Bench Test



Medical

- ▶ Position feedback
- ▶ Level measurement
- ▶ Machine alignment

- ▶ Assembly checking
- ▶ Closed loop control
- ▶ Tool positioning



# Non-Contact Measurement

## Chromatic Confocal

- ▶ Compact 8 mm diameter sensor
- ▶ Excellent on shiny surfaces
- ▶ Excellent on clear materials
- ▶ Clear Material Thickness measurement with one sensor
- ▶ Small measurement spot size
- ▶ No beam interference between adjacent sensors



## Laser Triangulation

- ▶ Auto Gain Circuitry
- ▶ Long measurement range
- ▶ Up to 40 kHz sample rate
- ▶ Excellent on dull / rougher surfaces
- ▶ Large visible spot size
- ▶ Excellent for dynamic / scanning applications



## Other Products

### Position Control and Displacement Measurement

Solartron offers full ranges of displacement sensors for industrial position, laboratory and test environments. Nearly all of these sensors can be integrated with the flexible Orbit® Measurement Network.

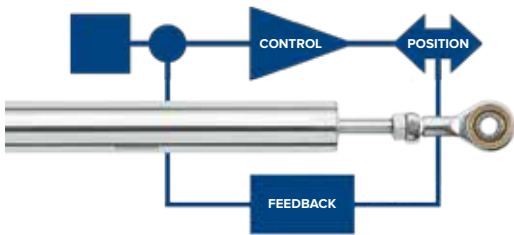

*Displacement transducers have been used in the following areas...*



Energy



Transport



Test



Structures



Electronics

- ▶ Motion control
- ▶ Distance control
- ▶ Crack monitoring
- ▶ Structure monitoring
- ▶ Material testing
- ▶ Research

## Key Application Factors

- ▶ Material
- ▶ Surface roughness
- ▶ Tolerance
- ▶ Speed in which it must be measured
- ▶ Contact allowed?
- ▶ Non-contact feasible?
- ▶ Environment
- ▶ Humidity
- ▶ Temperature
- ▶ Vibration
- ▶ Mounting of sensors
- ▶ Contact your local Solartron representative for the best sensor recommendation

# Orbit® Using the Digital Measuring Network

The Orbit® Measuring Network is a modular system that can be put together quickly, easily and cost effectively allowing many different types of sensors, not just linear probes, to be simply interfaced. Key elements of the network are the software drivers and library giving the network vast scope for high speed data capture and process.

## What do

Go straight out  
of the box

Install the Orbit® Support  
Pack for Windows®

Use Orbit® Measure Lite

Display the transducer  
readings, log data to a file



Go straight into a  
spreadsheet

Install the Orbit® Support  
Pack for Windows®

Install the Excel® Add In

Read data from Orbit®  
into Excel®, Post Process  
and generate graphics

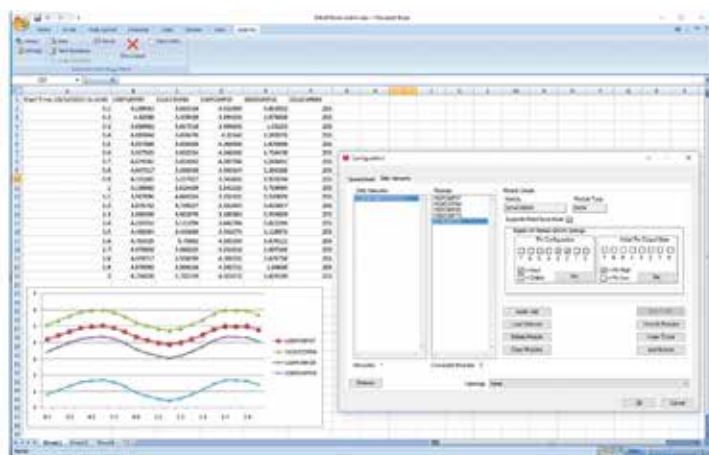
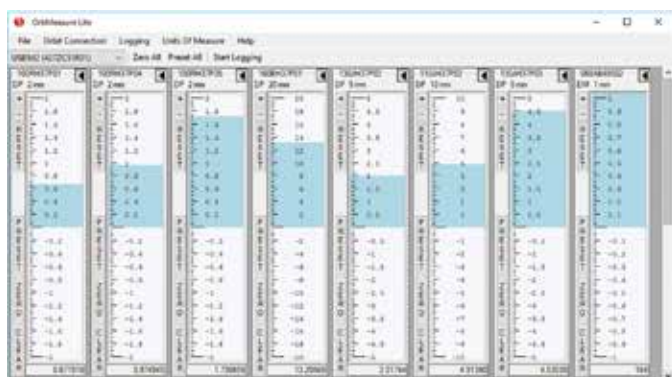

**OrbMeasureLite** is a simple to use application which gives the user the ability to set up a network and display the data in graphical format on a PC. Data can also be logged to Excel®. The Excel® add in can be used to facilitate building application specific spreadsheets.

Solartron also supports LabVIEW® with Orbit® for direct connection.

# Orbit® Using the Digital Measuring Network

Connect Orbit® to SPC, Excel®, or build your own program with the Orbit® Support Pack. Use our PLC interface modules or Readouts for a stand alone system.

## you want?

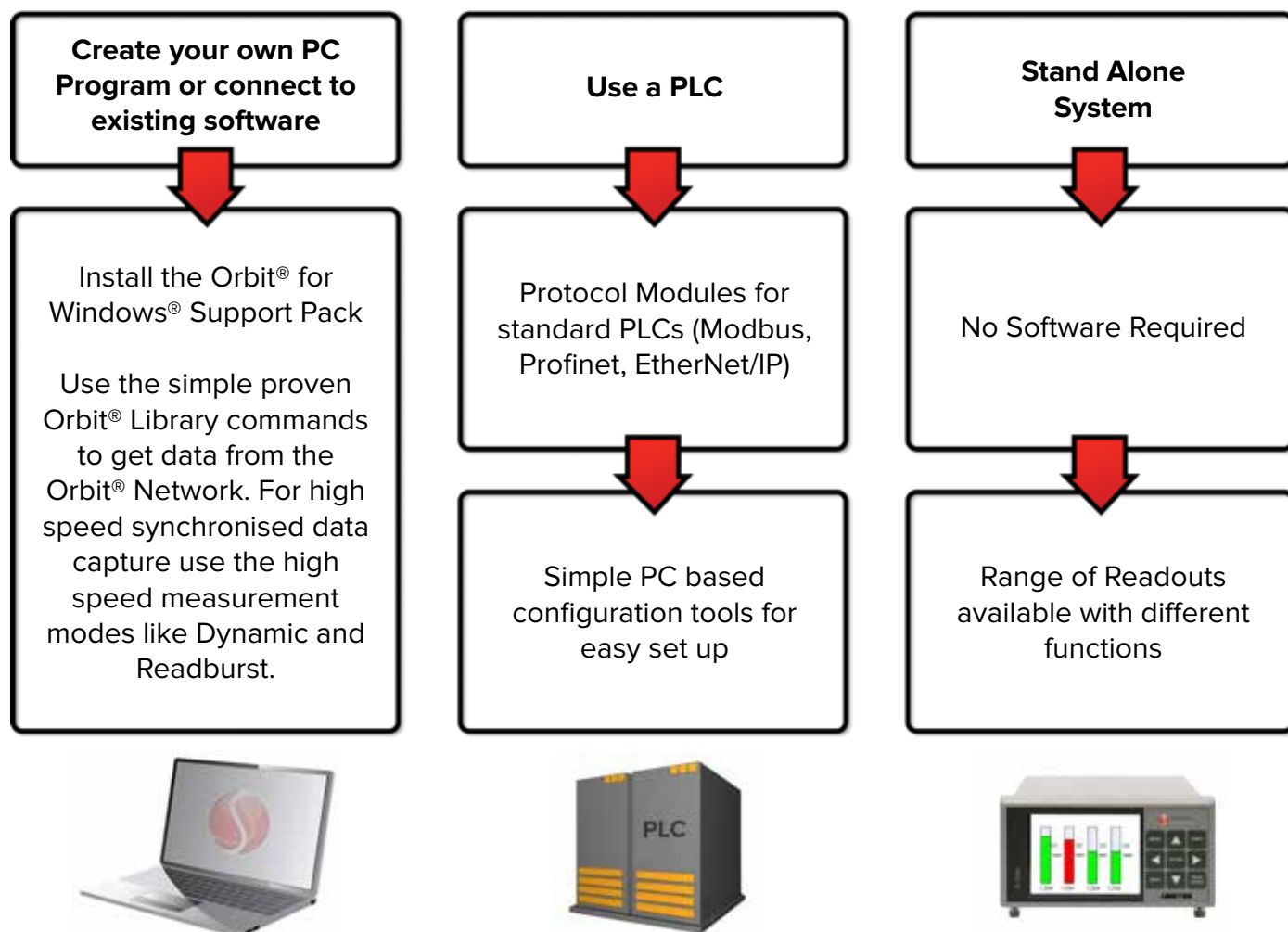

The Orbit® Library is specifically designed for the Microsoft® .Net Framework that is included with all Windows® operating systems from Windows XP® onwards. Using this library greatly simplifies the development of Orbit® systems. One of the main features of the Orbit® Library is the ability to get data from the network in several ways, providing solutions to many common measurement problems.

### FEATURES

- ▶ Windows® 10, 8.1, 7, and XP in both 64 bit and 32 bit
- ▶ Orbit® Library - based on Microsoft .NET Framework
- ▶ OrbMeasureLite Application – free simple application removes need to write software
- ▶ Excel® Add In - Orbit® straight into Excel®
- ▶ Orbit® Library Test application contains source code for all Orbit® commands which may be used by customers to develop own applications
- ▶ Language specific programming examples
- ▶ Detailed documentation and help files

# Orbit® - A universal truth

Data is only of value when it is processed from a reliable source

All standard transducer cables feature a polyurethane sheath with a foil screen layer for excellent electrical screening. The cable is very flexible

Indicator lamps show power and data transmission active

Strong, and lightweight body with internal electrical screening

Machined from solid, hardened stainless steel

Titanium core carrier, inert and able to withstand lateral shock

Internal screen to protect from magnetic fields

PIE (Probe Interface Electronics)

35 mm DIN rail mount for PIE, strong, lightweight construction. Holds the sensor address

Tight tolerance bearing with carbon/chrome balls providing good repeatability with long life

Anti rotation device designed to be strong and provide great repeatability even with probe tip off centre

Probe design endures a harsh "stepped cam" test where probe is actuated with a sideload. Probes last over 13 million cycles while maintaining repeatability

## Unerring data collection + Powerful processing = Rock Solid Results

Good original data can be ruined by noisy signal conditioning and poor immunity from electrical interference which in turn affects the repeatability of results. Orbit® processes and transmits clean, repeatable data from sensors at high speeds of up to 3906 readings per second.

A reliable sensor is essential to any data processing system. All Solartron Orbit® based sensors and mechanical interfaces are designed to generate reliable data, not just from new but for millions of cycles.

Data is only of use if it can be displayed and/or acted on. Orbit® offers a range of displays and readouts, interface modules and software for both PC and PLC based systems. The Excel® Add-In provides a simple way to get data into Excel®. PLC systems are addressed with various interfaces.

# Orbit® Digital Measuring Probes

Contact gauge probes often provide the most cost effective solution for a wide range of measuring and positioning applications. These have excellent sideload capabilities and can last over 100 million cycles.



## DP/S - Spring Push

- ▶ 0.5, 1, 2, 5, 10 & 20 mm measuring ranges
- ▶ Accuracy as low as <math>< 0.1 \mu\text{m}</math>
- ▶ Up to - ▶ Up to - ▶ Tip force of 0.7 N (options available)
- ▶ IP65 Sealing



The DP range of spring push probes is the work horse of the gauging industry. Very high resolution, excellent linearity and high data speeds is coupled with outstanding measurement repeatability. Long life precision bearings and IP65 sealing ensures that the probes maintain their performance for millions of measurements.



## DP/P - Pneumatic Push

- ▶ 2, 5, 10, & 20 mm measuring ranges
- ▶ Accuracy as low as <math>< 0.1 \mu\text{m}</math>
- ▶ Up to - ▶ Up to - ▶ Tip force of 0.7 N (0.4 bar of pressure)
- ▶ IP65 Sealing
- ▶ Pneumatic gaiter actuation
- ▶ Vacuum retract option available



Pneumatic transducers are ideal for use in automatic gauging applications or for accessing details that would be difficult or impossible to reach with spring push transducers. The standard range of Pneumatic Probes comes with IP65 sealing to ensure a long working life in wet or oily environments.



## DJ/P - Pneumatic Push

- ▶ 2, 5, 10 & 20 mm measuring ranges
- ▶ Actuation is by a built in piston, separate from gaiter
- ▶ Same performance as standard Pneumatic probe



Jet "J Type" probes are similar to standard pneumatic transducers except that actuation is by an inbuilt piston. High tip forces are available but as air is vented through a port close to the front of the probe, they have a lower IP rating. These probes will continue to operate even if the gaiter becomes punctured.



Application: Diameter Check

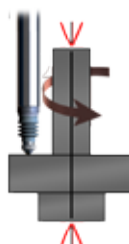

Application: TIR (Max - Min)



Application: Flatness

# Orbit® Low Tip Force and Rugged Probes



## DT - Feather Touch - Spring and Pneumatic

- ▶ Low tip force as low as 0.18 N (options available)
- ▶ 2, 5, 10, 20 & 30 mm Measuring Ranges
- ▶ Full range of tips available
- ▶ Pneumatic or Spring actuation
- ▶ IP50 Sealing
- ▶ Excellent sideload capability

Feather Touch transducers have been designed especially to gauge or measure delicate surfaces such as car windscreens, pharmaceutical bottles, electro-mechanical components and plastic parts. Where as a traditional transducer exerts a tip force of approximately 0.7 N, the Feather Touch exerts a mere 0.18 N when used in the horizontal position. This reduction is achieved by replacing the gaiter with a close tolerance gland. Despite the low volume of air flow the bearing is constantly purged, avoiding the build up of dust.



## DW - Ultra Feather Touch - Spring and Pneumatic

- ▶ Ultra Low tip force of 0.03 to 0.06 N
- ▶ 10 mm Measuring Range
- ▶ Nylon and Ruby tips available
- ▶ Pneumatic or Spring actuation
- ▶ IP50 Sealing

The Ultra Feather Touch probe has so light a tip force, it is a viable alternative to a non-contact sensor in many applications. With various tips available in ruby and nylon, the UFT is already being used to check glass, rubber, semi-conductor wafers and other delicate materials.



Application: Glass Thickness

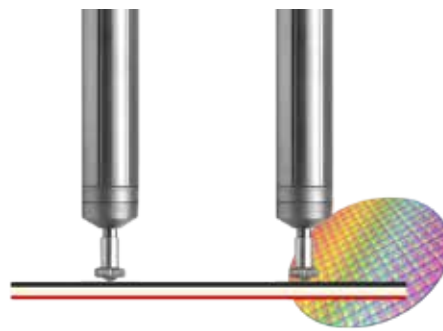

Application: Semi Conductor Wafer



Application: Hard Disk Drive Case



## D12P - Rugged probes for harsh environments

- ▶ Thicker, more rugged design for harsh environments
- ▶ 5 mm diameter shaft inside 12 mm diameter body
- ▶ Excellent strength and sideload capability
- ▶ IP65 Sealing

The Rugged digital probe is an option for environments where a standard probe may be easily damaged. The base performance of these products is identical to the  $\varnothing 8$  mm range. Contact Solartron for details.

# Orbit® Compact Probes



## D6P - 6 mm Diameter - Spring and Pneumatic

- ▶ 2, 5, and 12 mm Measuring Ranges
- ▶ 6 mm Diameter body
- ▶ Same resolution and repeatability as 8 mm probes
- ▶ Excellent when points are in close proximity
- ▶ IP65 Sealing

With the D6P probes, a 25% diameter reduction over conventional probes has been achieved, yet performance and life expectancy has been maintained. Long life precision bearings ensure that probes maintain their performance for millions of cycles.



6 mm probes checking the thickness of a coin



## D3P - 3 mm Diameter - Spring Push

- ▶ 1 mm Measuring Range
- ▶ 3 mm Diameter body
- ▶ IP50 Sealing

Quite possibly the world's thinnest probe, the tiny 3 mm diameter allows for even tighter packing densities for measuring features on intricate parts.



## DZ - Ultra Short Spring

- ▶ 1 or 2 mm measuring ranges
- ▶ Tip force 0.7 N (options available)
- ▶ IP65 Sealing
- ▶ Spring actuation
- ▶ R/A Outlets available
- ▶ Use where space is a premium

The DZ range of probes are probably the shortest available on the market with a full calibrated measuring range of 1 mm or 2 mm. The unique bearing design creates a very short probe body while still maintaining the performance of a standard probe.



8, 6 and 3 mm diameter probes

## Digital Probes with in line connectors

A complimentary range to the standard hard wired digital transducer, where the Orbit® electronics and the transducer have an in-line connector. The connector can be mounted close to the probe so that the probe can be replaced without having to unthread / thread the cable.

Probes can be replaced without any re-programming of the controlling software. The small diameter of the connector allows easy machine installation.



# Orbit® Digital Measuring Probes

Products (Note 4)	Standard, Spring, Pneumatic and Feather Touch					
Spring Push Axial Cable	DPR/0.5/S	DP/1/S	DP/2/S	DP/5/S	DP/10/S	DP/20/S
Spring Push Axial Cable Feather Touch	N/A	N/A	DT/2/S	DT/5/S	DT/10/S	DT/20/S
Pneumatic Axial Cable			DP/2/P	DP/5/P	DP/10/P	DP/20/P
Pneumatic Axial Cable Feather Touch			DT/2/P	DT/5/P	DT/10/P	DT/20/P
Pneumatic Axial Cable Jet			DJ/2/P	DJ/5/P	DJ/10/P	DJ/20/P
Diameter	8h6					
Measurement Performance						
Measurement Range (mm)	0.5	1	2	5	10	20
Accuracy (% of Reading) (Note 1)	0.05	0.05	0.05	0.05	0.06	0.07
Accuracy (% of Reading) (Note 1) - with In line Connector	N/A	0.20	0.20	0.15	0.15	0.15
Repeatability (worst case) µm (Note 2)	0.10	0.15	0.15	0.15	0.15	0.25
Repeatability (typical) µm (Note 3)	0.05	0.05	0.05	0.05	0.07	0.10
Resolution (µm)	0.01	0.01	0.01	0.05	0.05	0.1
Pre Travel (mm)	0.03	0.15	0.15	0.15	0.15	0.15
Post Travel (mm)	0.05	0.35	0.85	0.85	0.85	0.85
Tip Force (N) at Middle of Range ±20%						
Spring Push	0.70	0.70	0.70	0.70	0.70	0.70
Spring Push Feather Touch	0.30	0.30	0.30	0.30	0.30	0.30
Pneumatic at 0.4 bar	N/A	N/A	0.70	0.70	0.70	0.70
Pneumatic at 1 bar	N/A	N/A	2.60	2.60	2.60	2.60
Pneumatic Feather Touch ±30% at 0.3 bar	N/A	N/A	0.18	0.18	0.18	0.18
Pneumatic Feather Touch ±30% at 1 bar	N/A	N/A	1.10	1.10	1.10	1.10
Pneumatic Jet ±30% at 1 bar (Note 6)	N/A	N/A	0.85	0.85	0.85	0.85
Temperature Coefficient %FS/°C	0.01	0.01	0.01	0.01	0.01	0.01
Environmental						
Sealing for Probe	IP65 with gaiter or IP50 without gaiter					
Sealing for Probe Interface Electronics	IP43 for module and TCON					
Storage Temperature (°C)	-20 to +80					
Probe Operating Temperature with Gaiter (°C)	+5 to +80					
Probe Operating Temperature without Gaiter (°C)	-10 to +80					
Electronics Operating Temperature (°C)	0 to 60					
EMC Emission	EN61000-6-3					
EMC Immunity	EN61000-6-2					
Probe life (Operating Cycles)	100 million cycles (no side load), > 10 million cycles in most applications					
Material						
Probe Body						
Probe Tip (options)						
Gaiter (Note 5)	Fluoroelastomer or Silicon					
Cable						
Electronics Module						
Electronics Interface (Orbit®)						
Orbit® Interface options						
Reading Rate						
Bandwidth of Electronics (Hz) user selectable						
Power						

- ▶ Note 1: Accuracy 0.1 µm or % reading whichever is greater
- ▶ Note 2: Repeated operation against a carbide target with side load applied to the bearing using max-min
- ▶ Note 3: Repeated operation against a carbide target standard deviation from average (68%)
- ▶ Note 4: Right angle outlet versions of all of the standard 8h6 diameter probes for measuring ranges 2 mm to 20 mm are available, part description add R after first two letters e.g DPR/2/S is right angled version of DP/2/S
- ▶ Note 5: Different gaiter materials available for specific applications - Fluoroelastomer standard option
- ▶ Note 6: D6P/2/P @ 0.8 bar, D6J/5/P and D6J/12/P at 0.9 bar



# Technical Specifications

		Ultra Feather Touch	Ultra Short		Narrow Body				
N/A	DP/10/2/S	DW/10/S	DZ/1/S	DZ/2/S	D6P/2/S	D6P/5/S	N/A	D3P/1/S	
	DT/10/2/S	N/A	N/A	N/A	N/A	N/A	N/A	N/A	
DT/30/P	DP/10/2/S	DW/10/P	N/A	N/A	N/A	N/A	N/A	N/A	
	DT/10/2/S	N/A	N/A	N/A	N/A	N/A	N/A	N/A	
	DJ/10/2/S	N/A	N/A	N/A	N/A	D6J/5/P	D6J/12/P	N/A	
			8h6		D6J/2/P	6h6		3h6	
30	2	10	1	2	2	5	12	1	
0.1	0.05	0.06	0.10	0.10	0.05	0.05	0.10	0.20	
0.2	0.20	0.15	0.15	0.15	0.15	0.15	0.50	0.30	
0.5	0.15	0.15	0.05	0.05	0.05	0.05	0.25	0.5	
0.25	0.05	0.05	0.01	0.01	0.01	0.05	0.1	0.25	
0.2	0.01	0.01	0.15	0.15	0.15	0.15	0.15	0.01	
0.15	0.15	0.15	0.35	0.35	0.15	0.15	0.15	0.075	
0.85	8.85	0.85	0.35	0.35	0.85	0.85	0.85	0.30	
N/A	0.70	0.03 to 0.06	0.70	0.70	0.70	0.70	N/A	0.50	
N/A	0.30	0.03 to 0.06	0	N/A	N/A	N/A	N/A	N/A	
N/A	0.70	N/A	N/A	N/A	N/A	N/A	N/A	N/A	
N/A	2.60	N/A	N/A	N/A	N/A	N/A	N/A	N/A	
N/A	0.18	N/A	N/A	N/A	N/A	N/A	N/A	N/A	
0.85	1.10	N/A	N/A	N/A	N/A	N/A	N/A	N/A	
N/A	0.85	N/A	N/A	N/A	0.70	0.70	0.50	N/A	
0.03	0.01	0.01	0.01	0.01	0.01	0.01	0.01	0.03	
		IP50	IP65 with gaiter IP43 for module and TCON -20 to +80				IP50		+5 to +65
		N/A	+5 to +80						+5 to +65
								-10 to +80	N/A
								0 to 60	
								EN61000-6-3	
								EN61000-6-2	
								> 10 million	
Stainless Steel									
Nylon, Ruby, Silicon Nitride, Tungsten Carbide									
		N/A	Fluoroelastomer			Silicon		Fluoroelastomer	
PUR									
ABS									
USB, Ethernet, RS232, Modbus, EtherNet/IP, Bluetooth™									
3906 readings per second									
460, 230, 115, 58, 29, 14, 7, 4									
5±0.25 VDC @ 0.06 A typical									

# Orbit® Digital Specialist Transducers

Solartron's specialist gauging and measurement transducers are for applications where the standard pencil style probe will not fit.



## DK - Block Gauge

- ▶ Accuracy better than 1  $\mu\text{m}$
- ▶ Excellent Repeatability to 0.25  $\mu\text{m}$
- ▶ Measurement ranges of 2, 5 & 10 mm
- ▶ Spring or Pneumatic Actuation
- ▶ Multiple configurations with Top Tools and Tip holders

Solartron's Block Gauges makes precision measurements of bores and cavities a simple and reliable process. More generally, the use of these devices is recommended in applications where space and access is limited and where the use of axial probes is not possible. The 2 mm Block Gauge is only 8 mm wide.

The Block Gauges offer unrivalled ruggedness, accuracy and repeatability. All three units are extremely versatile and provide datum surfaces and all the adjustments required for precision gauging applications. Block Gauges have robust precision linear bearings with minimal clearance, which limits unmeasured movements maintaining good repeatability even when the contact tip is mounted off centre.



## Spring and Pneumatic Configurations

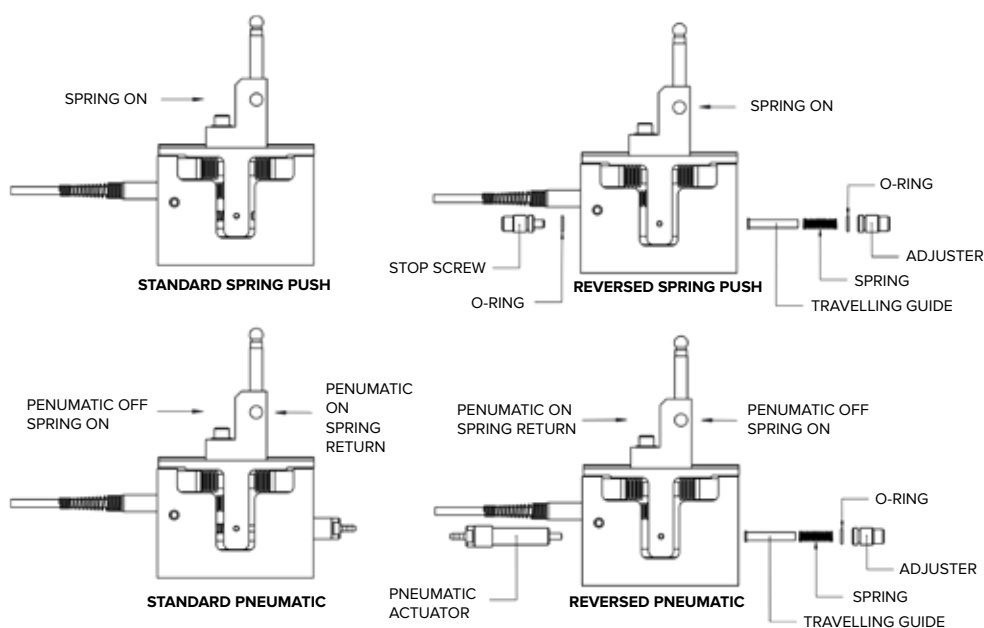

Spring and Pneumatic kits enable the automatic loading of components. Pneumatic actuation coupled with a spring controls the tip force for accurate measurements.

# Orbit® Digital Specialist Transducers



## DU - Flexures - Spring and Pneumatic

- ▶ 0.5, 1, and 2 mm ranges
- ▶ Width as thin as 4 mm (0.5 mm range)
- ▶ Accuracy better than 1 µm
- ▶ Repeatability to 0.05 µm
- ▶ Pneumatic or spring actuation (pneumatic 1 and 2 mm only)
- ▶ Removable leaves for ease of repair
- ▶ IP65 Protection

Parallel Flexures with high resolution and excellent repeatability make Solartron's Flexure Transducers the first choice for high speed precision gauging. With no sliding moving parts, the flexure will maintain performance for millions of cycles and are virtually free from hysteresis.

Flexures can be mounted such that there is little or no stress through the gauge line enabling precision profiling of moving materials such as rotating shafts, brake discs etc. With resolution better than 0.05 µm at speeds up to 3906 readings per second, the flexure with Orbit® provides an excellent dynamic solution.

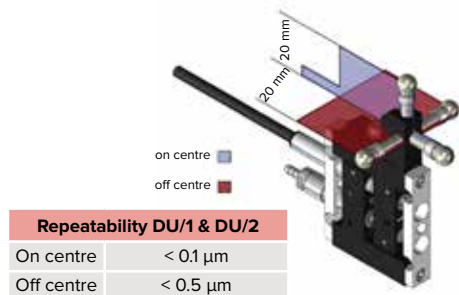

Repeatability DU/1 & DU/2	
On centre	< 0.1 µm
Off centre	< 0.5 µm



Application:  
Rod Diameter



Application:  
Bearing Check

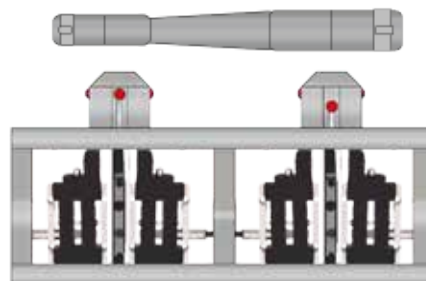

Application: Connecting Rod



## DUS - Single Leaf Flexures

- ▶ 0.5 mm range
- ▶ Spring actuation
- ▶ Normal or reverse actions
- ▶ Extension arms
- ▶ IP65 Protection



With the same advantages as the parallel flexure the single leaf flexure offers the gauge builder access to even more measurement points. With careful use of extension arms measurements can be made inside slots or between features where a conventional pencil probe cannot reach.

## Block Gauge and Flexure Accessories

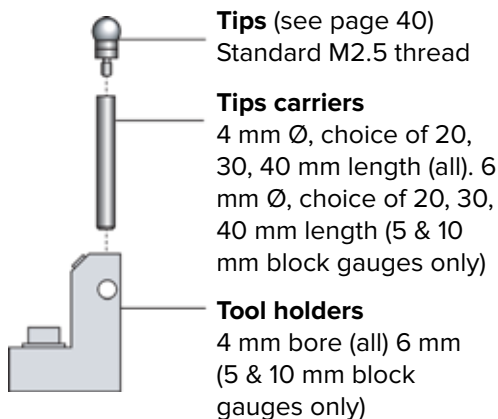

**Tips** (see page 40)  
Standard M2.5 thread

**Tips carriers**  
4 mm Ø, choice of 20, 30, 40 mm length (all). 6 mm Ø, choice of 20, 30, 40 mm length (5 & 10 mm block gauges only)

**Tool holders**  
4 mm bore (all) 6 mm (5 & 10 mm block gauges only)



**Pneumatic actuator**  
Block gauges and flexure gauges are supplied without pneumatic actuators as standard. Please order separately.



**Alternative Springs**  
A set of springs (of different forces) is included with each gauge. Replacements can be ordered individually or as sets.

# Orbit® Digital Specialist Transducers



## DUSM - Mini Flexure

- ▶ Accuracy better than 1  $\mu\text{m}$
- ▶ Excellent Repeatability <0.5  $\mu\text{m}$
- ▶ Measurement range 0.5 mm
- ▶ IP68 Sealing
- ▶ Multiple Tip Configurations
- ▶ Robust design in compact package

The Miniature Single Leaf Flexure is another variant of flexure based contact probes. The miniature single leaf flexure has a calibrated range of 0 – 500 microns and provides the means for alternative configurations of contact tip mounting.

The gauge body mounting to the fixture is accomplished using a single M2.5 screw. Contact tip mounting is attached by using either the integral M3 locking thread insert, primarily intended for use with length extensions, OEM's fixed length contact tips or with Solartron's tip adapter, which when applied with Solartron's dedicated tip allows for 1 mm of height adjustment. OEM tips may be fitted to either option, but it is advised that the height be limited to a maximum of 6 mm above the gauge top surface, to avoid significantly prejudicing gauge life and repeatability. Mid adjustment range is the reference point for the calibration using the standard tip.

Length extensions may be applied to this style of gauge but should be used with care. A maximum length of 12 mm, between tip and mounting thread, is advised, but this does depend on other variables such as tip height approach angle and measurement deflection – extremes of these conditions will significantly reduce the gauge life and severely degrade the repeatability. To enable direct reading of the gauge using extensions, the use of a software multiplier will be necessary. However, as the reference dimension for the gauge is 18 mm by using a 12 mm extension, a range of 833 microns is achieved but a reading of only 500 microns is observed.



## DM - Mini Probe

- ▶ Accuracy better than 1  $\mu\text{m}$
- ▶ Measurement ranges 0.5 and 1 mm
- ▶ Spring Actuation



The Mini Probe is a compact, low profile transducer that is ideal for measurement in confined spaces, such as bores. The transducer is based on a parallel spring structure that ensures excellent repeatability over a long working life, even when rotated in bores that have key slots or lubrication ports.

A Tungsten Carbide contact tip is fitted as standard but a selection of customer replaceable tips with an M2 thread is available for special applications.

Repeatability depends on the alignment of the mini probe whether on axis or cross axis as shown in the diagram.



# Orbit® Digital Specialist Transducers



## DL - Lever Probe

- ▶ Accuracy better than 3  $\mu\text{m}$
- ▶ Measurement range 0.5 mm
- ▶ Spring Actuation
- ▶ 2 g to 20 g tip force

Solartron's Digital Lever Probe has been conceived for the precision measurement market. The probe is ideally suited to applications where the use of axial measuring probes is not possible, and where a low tip force and a high number of probing points are required. Its simple design and exceptional reliability result in a reduced cost of ownership without any reduction in performance.

Due to its cylindrical housing geometry, the Lever Probe can be mounted in any attitude relative to the intended target, although the stylus motion must be normal to the intended measurement.

## Lever probe mounting blocks and styli

Ball $\varnothing$	Stylus
0.38	
0.79	
1.59	
2.54	

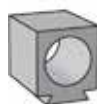

Dovetail Mounting Block

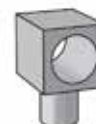

8 mm peg mounting block

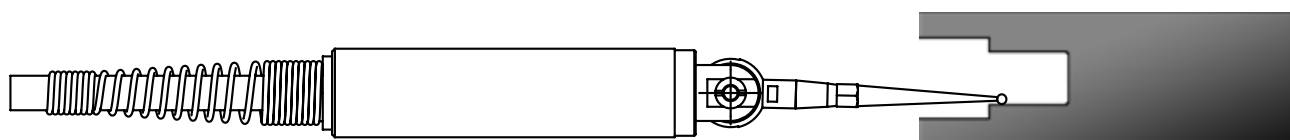

Application: Check Camshaft Bearings and Alignment

# Orbit® Digital Specialist Transducers

	Block Gauges			Lever	
Axial Cable Outlet	DK/2	DK/5	DK/10	DL/0.5/S	
Radial Cable Outlet	DKR/2	DKR/5	DKR/10	N/A	
Product Body Width (mm)	8	12		9.5 dia	
<b>Measurement Performance</b>					
Measurement Range (mm) (Note 3)	2	5	10	0.5	
Accuracy (% of Reading) (Note 1)	0.05	0.05	0.08	1.2 (Note 5)	
Repeatability (µm) (Note 2)	<0.25	<0.25	<0.5	On Axis Cross Axis	
Range:0-100 µm nominal	N/A	N/A	N/A	N/A	N/A
Range:100-250 µm nominal	N/A	N/A	N/A	N/A	N/A
Range:500-1000 µm nominal	N/A	N/A	N/A	<0.15	<0.3
Range:250-500 µm nominal	N/A	N/A	N/A	N/A	N/A
Resolution (µm)	0.01	0.05	0.05	<0.1	
Pre Travel (mm)	0.15	0.15	0.15	0.02/0.03	
Post Travel (mm)	0.85	0.85	0.85	0.06	
Tip Force (N) at Middle of Range ±20% (Horizontal)					
Spring Push	1.5	1.5	1.5	0.05-0.2	
Pneumatic at 2 bar		Note 6		N/A	
Temperature Coefficient (µm/°C)	0.2	0.5	1	0.1	
<b>Environmental</b>					
Sealing	IP65			IP43	
Sealing for Probe Interface Electronics					
Storage Temperature (°C)					
Block Gauge Operating Temperature (°C)					
Electronics Operating Temperature (°C)					
EMC Emissions					
EMC Immunity					
Shock	Do not subject Block Gauge to excessive shocks. This may damage the bearings.				
<b>Material</b>					
Block Gauge Body	Stainless Steel				
Probe Tip (options) (Note 4)	Nylon, Ruby, Silicon Nitride, Tungsten Carbide			Tungsten Carbide	
Gaiter	Fluoroelastomer or Silicon				
Cable					
Electronics Module					
<b>Electronics Interface (Orbit®)</b>					
Orbit® Interface Options					
Reading Rate					
Bandwidth of Electronics (Hz) user selectable					
Power					

- ▶ Note 1: Accuracy 0.1 µm or % whichever greater, assume 20 mm arm for block gauges and Applicable Parallel Flexures
- ▶ Note 2: Repeatability for Flexures depends on the configuration of the tip and holder - see diagram
- ▶ Note 3: DU/0.5/S - Range is at 50 mm from flex point, extension arms will multiply this parameter, for DUSM range is with no extension arm fitted
- ▶ Note 4: Lever Probe has tips in diameters of 2.54 mm, 1.59 mm, 0.79 mm, 0.39 mm mounting thread 1-74 UNF
- ▶ Note 5: Lever Probe accuracy with arm normal to axis of the stylus
- Note 6: Block gauge tip force is dependent on mounting attitude and spring for the pneumatic block gauge it is also air pressure and balancing spring combination

# Technical Specifications

Parallel Flexures						Single Flexures		
DM/0.5/S		DM/1/S		DU/0.5/S	DU/1/S	DU/2/S	DUS/0.5/S	DUSM/0.5/S
N/A		N/A		N/A	DUR/1/S	DUR/2/S	N/A	N/A
6.25				4	8		6	7
0.5		1		0.5	1	2	0.5	0.5
0.05		0.05		0.10	0.10	0.10	0.10	0.05
On Axis	Cross Axis	On Axis	Cross Axis	<0.1	<0.1	<0.1	<0.1	0.5
0.10	0.10	0.10	0.10	N/A	N/A	N/A	N/A	N/A
0.25	0.15	0.10	0.10	N/A	N/A	N/A	N/A	N/A
0.5	0.25	0.15	0.15	N/A	N/A	N/A	N/A	N/A
N/A	N/A	0.3	0.2	N/A	N/A	N/A	N/A	N/A
<0.1		<0.1		0.01	0.01	0.01	0.01	<0.1
0.01/0.02		0.015/0.025		0.03/0.06	0.05/0.1	0.05/0.1	0.02/0.03	0.01/0.02
0.07		0.07		0.29	0.4	0.4	0.05/0.1	0.07
0.7		0.7		0.5	1.5	1.5	1.25	0.8 ±50%
N/A				N/A	1	1	N/A	N/A
0.08		0.8		0.5	0.5	0.5	0.5	0.1
IP60				IP65			IP65	IP68
IP43 for module and TCON								
-20 to +80								
+5 to +80								
0 to 60								
EN61000-6-3								
EN61000-6-2								
Do not subject any flexure products to excessive loads, follow instructions when adjusting								
Nylon, Ruby, Silicon Nitride, Tungsten Carbide								
Fluoroelastomer						Fluoroelastomer		
PUR								
ABS								
USB, Ethernet, RS232, Modbus, EtherNet/IP, Bluetooth™								
3906 Readings per second								
460, 230, 115, 58, 29, 14, 7, 4								
5±0.25 VDC @ 0.06 A typical								

# Orbit® Non-Contact - Chromatic Confocal

For applications where a contact gauging sensor is unsuitable Solartron offers a Non-contact **Confocal Measurement Transducer**. This cost effective solution has the compact size of a gauging probe, along with the flexibility of the Orbit® Measurement Network.

orbit **CONFOCAL**

## Features

- ▶ Compact 8 mm diameter Transducer Head
- ▶ Excellent for measurements on reflective surfaces or glass
- ▶ Measures thickness of clear materials 0.4 mm to 4 mm
- ▶ Refractive Index correction
- ▶ 8 mm or 24 mm stand off
- ▶ 1.5 mm or 5 mm measuring range
- ▶ Repeatability  $\pm 1 \mu\text{m}$
- ▶ Three modes of operation
  - ▶ Single Probe
  - ▶ Single Probe clear material thickness measurement
  - ▶ Dual Probe – Two heads one controller, B+A
- ▶ Operates with Orbit® Measurement Network, easily integrates with other sensors
- ▶ USB, Ethernet TCP, RS232, Wireless Bluetooth™, Modbus, EtherNet/IP, Profinet interfaces

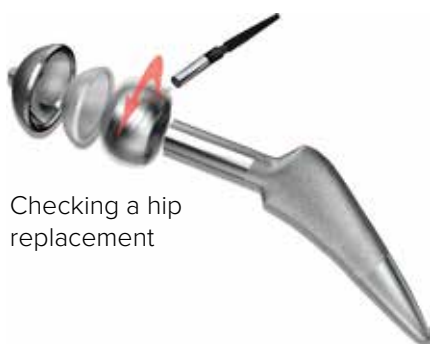

Checking a hip replacement



Checking Phone Glass alongside lasers using Orbit®

## Controller

Measurement

Connection for Confocal heads

Signal Level Indication



Zero / Abs Select / Indication



# Technical Specifications

Products		Confocal Head Types	
Axial Beam Output		C8H/8/1.5	C8H/24/5
Right Angle Beam Out		-	C8HR/8/5
Measurement Performance			
Calibrated Range (mm)		1.5	5
Standoff	mm	8	24 (8 for R/A)
Linearity (full range) (Note 1)	%FSO	0.4	0.2
	$\mu\text{m}$	5	10
Linearity (limited range) (Note 2)	%FSO	0.2	0.1
	$\mu\text{m}$	2.5	5
Resolution	$\mu\text{m}$	1	1
Repeatability (Note 1)	$\mu\text{m}$	2	2
Operating Angle	$\pm^\circ$	5	3
Spot Diameter	$\mu\text{m}$	30	30
Temperature Coefficient (Note 5)	$\mu\text{m}/^\circ\text{C}$	2	2
Function			
Light Output Level	8 settings to accommodate different levels of reflective surfaces		
Exposure settings	5 ms to 100 ms to accommodate different levels of reflective surfaces		
Averaging	1 to 256 set higher to improve signal to noise ratio		
Metrology (Mode)	Zero, Absolute, B-A, B+A		
Menu (Note 3)	Touch Screen		
Indications (Note 3)	Measurement, Signal Strength, Mode		
Environmental			
Operating Temperature	$^\circ\text{C}$	15 to 25	
Operating Temperature (Note 4)		15 to 35	
Humidity		Do not use / store in wet conditions	
Shock and Vibration		Do not subject to vibration / shock	
EMC Emissions		EN61000-6-3	
EMC Immunity		EN61000-6-2	
Electronics Interface (Orbit®)			
Orbit® Interface Options	USB, Ethernet, RS232, Modbus, EtherNet/IP, Bluetooth™		
Reading Rate	3906 readings per second		
Bandwidth of Electronics (Hz) user selectable	100 Hz Max		
Power	+24 VDC		

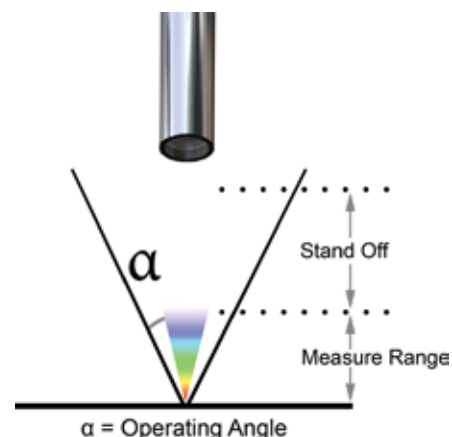

Confocal Right Angle Head

- ▶ Note 1: Performance on polished carbide steel, other surfaces, colours, finishes may degrade performance
- ▶ Note 2: As Note 1 limited to 10% of range either side of mid point
- ▶ Note 3: All set up and output data can be over the Orbit® Measurement Network
- ▶ Note 4: Performance may be degraded over this range
- ▶ Note 5: Head and controller combined

## Controller dimensions

The system is provided with a 2 m optical fibre between the head and controller. Other lengths can be used.

Please check controller dimensions on the right.

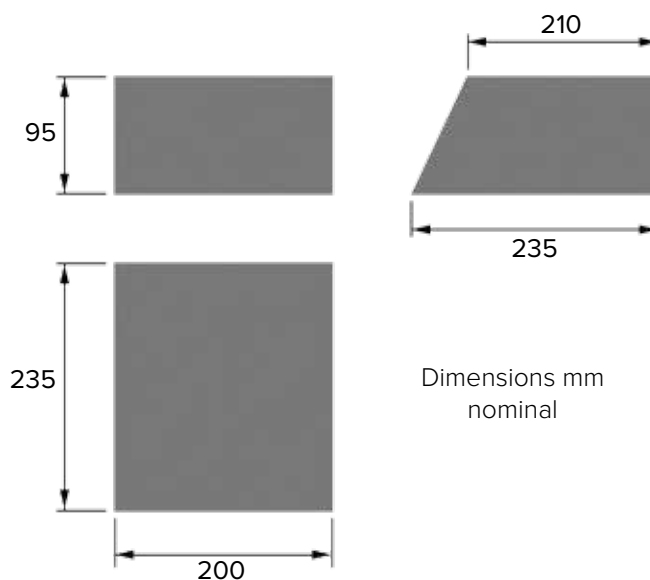

# Performance Specification – Single Probe

## Absolute Range Specification (Using full measurement range)

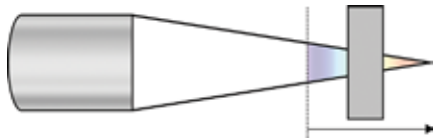

Range (mm)	1.5	5
Linearity ( $\mu\text{m}$ )	$\pm 10$	$\pm 20$
Repeatability ( $\mu\text{m}$ )	$\pm 1$	$\pm 2$

## Gauging Specification (When mastering at one point and checking over small operating range)

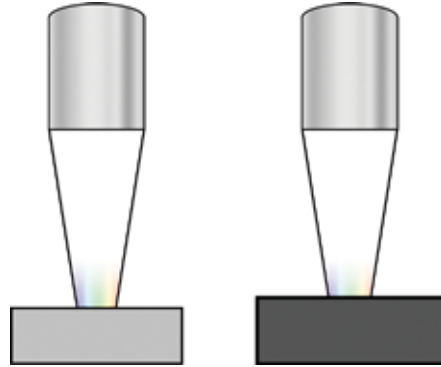

Range (mm)	1.5	5
Accuracy ( $\mu\text{m}$ )	$\pm 1$	$\pm 2$
Resolution ( $\mu\text{m}$ )	$\pm 0.5$	$\pm 0.5$

## Single Probe Thickness for Clear Materials

Absolute Range Specification (Using full measurement range)



Range (mm)	1.5	5
Min Thickness	0.4	1
Max Thickness	1	4
Accuracy ( $\mu\text{m}$ )	$\pm 20$	$\pm 50$
Repeatability	$\pm 2$	$\pm 4$

## Gauging Specification (When mastering at one point and checking over small operating range)

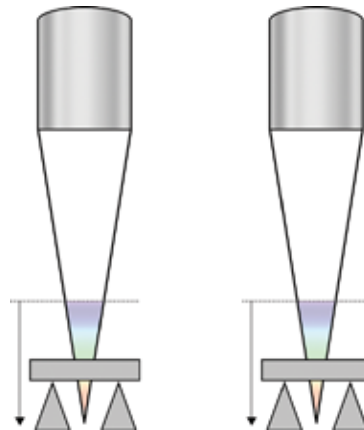

Range (mm)	1.5	5
Min Thickness (mm)	0.4	1
Max Thickness	1	4
Accuracy ( $\mu\text{m}$ )	$\pm 2.5$	$\pm 5$
Repeatability ( $\mu\text{m}$ )	$\pm 2$	$\pm 4$

# Performance Specification – Dual Probes

## Absolute Range Specification (Using full measurement range)



Range (mm)	1.5	5
Accuracy ( $\mu\text{m}$ )	$\pm 15$	$\pm 30$
Repeatability ( $\mu\text{m}$ )	$\pm 2$	$\pm 4$
Resolution ( $\mu\text{m}$ )	$\pm 0.5$	$\pm 0.5$

## Gauging Specification (When mastering at one point and checking over small operating range)



Master



Part

Range (mm)	1.5	5
Accuracy ( $\mu\text{m}$ )	$\pm 2$	$\pm 4$
Repeatability ( $\mu\text{m}$ )	$\pm 1$	$\pm 2$
Resolution ( $\mu\text{m}$ )	$\pm 0.5$	$\pm 0.5$

## Typical Applications

Hearing Aid



Hip Joints

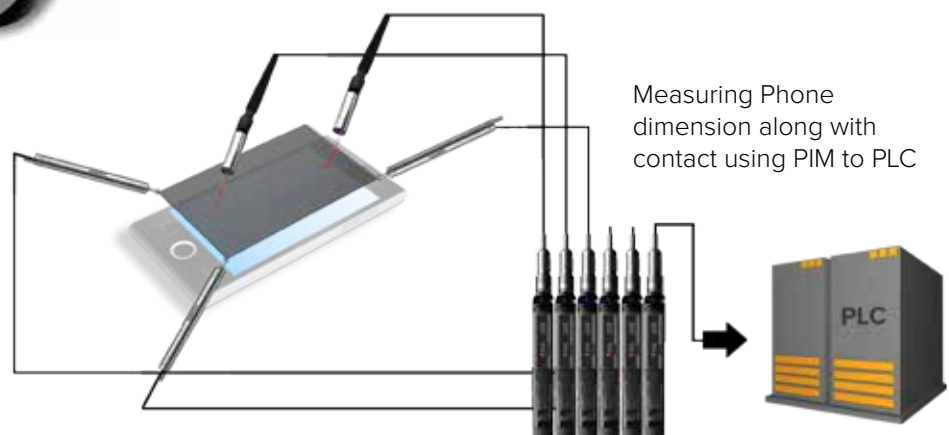
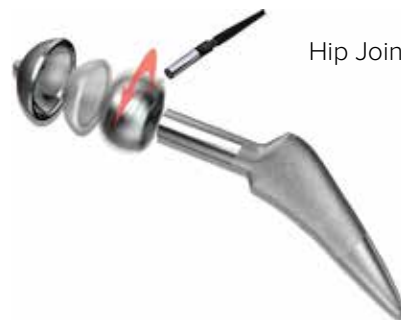

# Orbit® Non-Contact - Laser Triangulation

For applications where a contact gauging sensor or Confocal is unsuitable, Solartron offers a range of high performance or low cost Non-Contact Laser Triangulation Transducers. This solution is fully compatible with the Orbit® Measurement Network.

## LTH and LTM Features

- ▶ 2 mm to 200 mm measurement ranges
- ▶ Up to +/- 0.02% F.S. Accuracy
- ▶ Up to 0.0076  $\mu\text{m}$  resolution
- ▶ 40 kHz sampling speed and up to 4 kHz output
- ▶ Laser Beam Control – on or off
- ▶ Plugs into Orbit® network up to 150 sensors with full control
- ▶ Auto gain circuitry – power automatically adjusts for optimum measurement
- ▶ Gap Time - Bridging function used when measuring parts with holes
- ▶ Diffuse or Specular modes

## LT Features

- ▶ 15 mm measurement range with 45 mm offset
- ▶ Teachable settings for different surfaces
- ▶ 0.1% F.S. Accuracy
- ▶ 3  $\mu\text{m}$  resolution

Laser Beam Control – the laser beam can be switched off, allowing multiple lasers to measure points very close together where the beams could interfere. In the beam off mode, the laser head is still powered allowing readings to be taken quickly (0.5 S) after turning the beam on. Beam control is via the Orbit® interface or via the Orbit® ACS using either the Menu or Modbus commands. The laser functions via the Orbit®, interface using Ethernet, Modbus, USB or Serial (RS232). The LTH can also be used with the Orbit® ACS products (with integral display) where control is via the menu or via Orbit® ACS Modbus interface.



# Technical Specifications

	High Performance Lasers							Low Cost Laser
Product	LTMD/25/2/B	LTMD/50/10/B	LTHM/50/20/B	LTHM/120/20/B	LTHM/120/40/B	LTHM/200/100/B	LTHM/300/200/B	LT/15/A
	LTHD/25/2/B	LTHD/50/10/B	-	-	-	-	-	-
Range (mm)	2	10	20	20	40	100	200	15
Offset (mm) (Note 1)	25	50	50	120	120	200	300	53
Spot Size (µm)	ø30	ø36	ø36	ø100	ø100	ø100	ø130	400x600
Laser Angle °	45	30	30	20	20	12	8	-
<b>Linearity (±% FSO) (Note 2)</b>								
Best (±% FSO)	0.01	0.02	0.025	0.025	0.03	0.03	0.03	0.1
Typical (±% FSO)	0.02	0.04	0.045	0.06	0.05	0.04	0.04	
Best (±µm)	0.2	2	5	5	12	30	60	-
Typical (±µm)	0.4	4	9	12	20	40	80	-
<b>Repeatability (µm) (Note 3)</b>								
Best	0.1	0.2	0.4	0.5	1	3	7	3
Typical	0.2	0.4	0.8	1	2	6	15	
<b>Resolution (µm)</b>								
LTM (Note 4)	0.24	0.3	0.0763	0.0763	0.1526	0.3815	0.7629	
LTM (Note 5)	0.24	0.3	0.23	0.23	0.8	2	4	
LTH Versions	0.02	0.05	N/A	N/A	N/A	N/A	N/A	
LT	N/A	N/A	N/A	N/A	N/A	N/A	N/A	2
<b>Laser</b>								
Modes (Note 7)	Diffuse or Specular			Diffuse only			Diffuse	
Weight Head only (g)	203			460				
Power mW / Class (IEC 60825)	< 5 / 3R			< 5 / 3R			2	
Wavelength µm	670			670			650	
<b>Performance</b>								
Max Sampling Frequency (kHz)	40						450	
Orbit® Data Rate (Readings/sec)	3906							
Sampling Cycles	256/512 µS or 1/2/4/8/16/32/64 ms (Selectable)							
Working Bandwidth Hz (Note 6)	1300, 650, 325, 163, 81, 40, 20, 10, 5							

- ▶ Note 1: Distance from the laser face to the middle point of the measuring range (mm)
- ▶ Note 2: Measured on white photographic paper with the laser sample rate set to 4 kHz (LTM) or 4.5 Hz (LT) and averaging 4 ms
- ▶ Note 3: Measured on white photographic paper with the laser sample rate set to 4 kHz (LTM) or 4.5 Hz (LT) and averaging 16 ms, the laser beam is blocked between each measurement
- ▶ Note 4: Resolution 1 LSB of the Digital System
- ▶ Note 5: Standard Deviation of 25 Measurements with the laser pointing at a fixed white photographic paper target with the laser sample rate set to 4 kHz and averaging 16 ms
- ▶ Note 6: Real measurement bandwidth based on ability to reconstruct sine wave at filter frequency
- ▶ Note 7: Specular Mode is recommended for high reflective (shiny) surfaces. ND filter required, specify when ordering  
*The laser products require 24 V PSIM - See PSIM section*

# Wireless Measurement and Gauging

The freedom to roam with **Solartron's WiGauge™** brings increased efficiency to gauging stations and work practices. The ability to work without cables means that the gauging process is not restricted by cable length and routing, or the risk of cable damage.

The audio and visual pass/fail indicators on the WiGauge™ give the operator the opportunity to decide whether or not to remove a component from a machine tool while the reading is logged into a system that can be up to 15 metres away. The rugged construction and class 1 Bluetooth™ communication ensure that it is able to work reliably in the often hostile environment of an engineering machine shop. With an option of an integral LCD display the WiGauge™ offers even more flexibility.

Post process gauging stations become more flexible and with the ability to connect multiple WiGauge™ to a single receiver. Cable tangles are eliminated in multi-point gauging applications.



## WiGauge™ Wireless Bore Gauge

- ▶ 10 mm and 6 mm diameter fixing thread (as used on most popular gauge heads)
- ▶ LCD Screen option
- ▶ < 0.1 µm resolution (user selectable)
- ▶ Multiple WiGauge's can be connected to a single system or PC
- ▶ 10 hours battery life typical
- ▶ Inductive charging
- ▶ IP65 Sealing
- ▶ Pass / fail range lamps
- ▶ Audio indication of data transmission

Multi Channel™ used with Mini probes for bore measurement



Multi Channel WiGauge™ used with narrow body probes to create a crank gauge

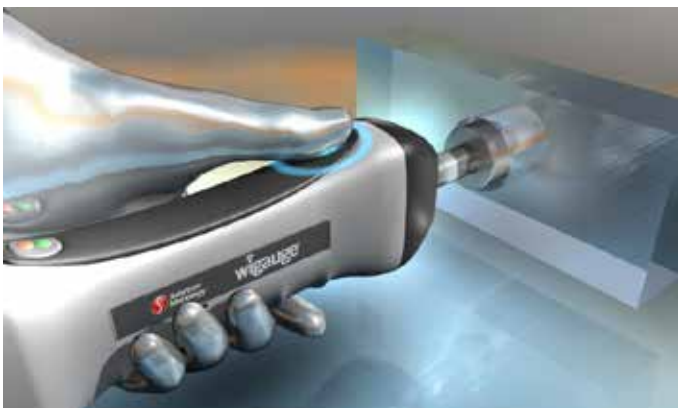

wigauge™

# Technical Specifications

	Single Channel	Multi Channel
	WHT/10/S	WHTM/n (n=1 to 8)
<b>WHT Performance</b>		
Measurement Range / Accuracy / Resolution / Repeatability	Depends on Head Fitted	Depends on sensors used
<b>Probe Measurement Performance</b>	<b>Internal</b>	<b>External</b>
Accuracy (% of Reading) (Note 1)	0.06	Depends on sensors used
Repeatability	0.07	Depends on sensors used
Resolution (µm)	0.05	Depends on sensors used
<b>Probe Mechanical Interface</b>	<b>Internal</b>	<b>External</b>
Pre Travel (mm)	0.15	Depends on sensors used
Post Travel (mm)	0.85	Depends on sensors used
<b>Electronics Interface</b>		
Bluetooth™	Class 1: Range 15 m Class 2 and Class 3 selectable	
Reading Rate	Up to 100 readings per second	
<b>Environmental</b>		
Sealing	IP65 (excluding head interface)	
Operating Temperature (°C)	5 to 60	
EMC Emissions	EN61000-6-3	
EMC Immunity	EN61000-6-2	
Power	Rechargeable Battery Pack	
<b>Material</b>		
Body	ABS and Nylon	
Internal	Stainless Steel	
<b>Display</b>		
Type	Colour LCD	
Protection	Acrylic Sealed Cover	

► Note 1: Accuracy 0.1 µm or % reading whichever is greater

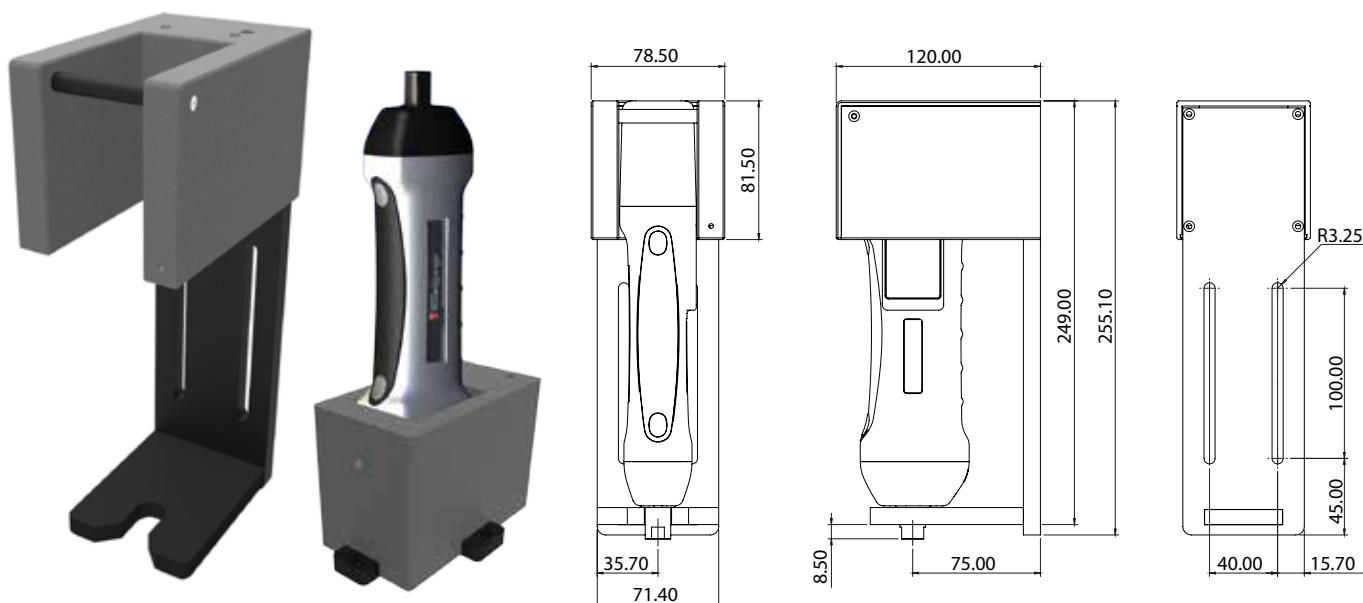

Various charger cradle options available.

# Orbit® Linear Encoders

The **Digital Linear Encoder** range of gauges consists of high accuracy optical probes designed for use in applications where consistent sub micron measurement accuracy is required. In contrast to traditional gauging probes, the accuracy is maintained along the entire measurement range.

The Digital Linear Encoder can be connected directly to a Solartron Digital Readout, a PC or a PLC via Solartron's Orbit® Network. The option to take readings with a resolution of <0.1 µm at speeds of up to 3906 readings per second per encoder into the Orbit® Network, provides detailed profiling.

Various spring forces are available to make sure the encoders can operate at any attitude. The proven high repeatability is a testament to the excellent mechanics and bearing used in the range.



**LE - Linear Encoder**

- ▶ Spring, free, pneumatic, cable release
- ▶ 0.4 µm accuracy
- ▶ 0.05 µm resolution

## Products

Spring Push	LE/12/S	LE/25/S
Pneumatic	LE/12/P	LE/25/P

## Measurement Performance

Measurement Range (mm)	12	25
Mechanical Range (mm)	13	26
Accuracy ± µm	0.4	
Repeatability (worst case) µm	0.1	
Resolution (µm)	0.05	
Ref. Mark Position from end stop (mm)	3 (nominal)	
Maximum Gauging Speed (ms <sup>-1</sup> )	0.5	
Tip Force (N) at Middle of Range ±20%		
Up / Down/ Horizontal (Spring Push)	0.1 / 0.6 / 0.5	
Temperature Coefficient (µm/°C)	-0.35 to -0.5	-0.4 to -0.7

## Environmental

Sealing for Probe no gaiter	IP50
Sealing for Probe with gaiter	IP65
Sealing for Probe Interface Electronics	IP43
Storage Temperature (°C)	-20 to +70
Probe Operating Temperature (°C)	+10 to +50
Electronics Operating Temperature (°C)	0 to +60
EMC Emissions	EN61000-6-3
EMC Immunity	EN61000-6-2
Probe Life (Operating Cycles)	>10 million

## Material

Case	Aluminum
Shaft	Stainless Steel
Probe Tip (options)	All available options
Gaiter	Fluoroelastomer
Cable	PUR
Electronics Module	ABS

## Electronics Interface (Orbit®)

Orbit® Interface Options	USB, Ethernet, RS232, Modbus, EtherNet/IP, Bluetooth™
Reading Rate	3906 readings per second
Power	5±0.25 VDC @ 0.06A typical

Accessories - Finger Lift





# Orbit® Accessories and Power Supplies

## Power Supplies (PSIM)



Technical Specifications						
Product		AC PSIM	AC PSIM/24/5	DC PSIM	DC PSIM/24/5	Aux AC PSIM/24
Primary Output	VDC	5	5	5	5	24
	Current (A)	1.8	1.8	1.8	1.8	1.0
Secondary Output	VDC	None	24 (Note 1)	None	24 (Note 1)	None
	Current (A)	None	1.0	None	(Note 2)	None
Max No Of Orbit® Modules		31	31	31	31	(Note 3)
Supply Voltage	VAC	100 to 240	100 to 240	N/A	N/A	100 to 240
	VDC	N/A	N/A	10 to 30	10 to 30	N/A
Supply Frequency	Hz	50-60	50-60	DC	DC	50-60
Supply Connection (Note 4)		IEC320 Plug		2 m cable	2 m cable	IEC320 Plug
Environmental						
Sealing		IP43 for Module and TCON				
Storage Temperature °C		-20 to +70				
Operating Temperature °C		0 to 60				
EMC Emissions		EN61000-6-3				
EMC Immunity		EN61000-6-2				
Weight and Dimensions		Standard Orbit® Module				

## Probe Accessories

### Replacement Gaiters

Gaiters can be replaced when damaged. Only pneumatic push probes require gaiter rings.



- ▶ Note 1: 24 V output of DC PSIM will track the DC input
- ▶ Note 2: 24 V current depends on external supply
- ▶ Note 3: The Aux AC PSIM only supplies 24 V auxiliary power for products that require additional 24 V in addition to the standard 5 V, these PSIMs do not power the Orbit® Network
- ▶ Note 4: The country specific mains cable is supplied when ordering

### Retrofit Right Angle Adaptor

For use with spring push gauging probes. Part Number: 203224



### Imperial Adaptor Sleeves

Adapter Sleeves can be used to increase the body diameter of 8 mm sensors to 9.512 (3/8"). Available in lengths from 12 to 127 mm. Available with or without a split.



### Clamping Collet

For use with all 8 mm diameter probes. The clamping collet distributes the clamping forces evenly around the probe body. Using the supplied grub screw, the probe can be loosened while holding the collet in place.

Part number: 806466-SX (10 mm)  
805048-SX (9.5 mm)



# Special Orbit® Modules

Solartron offers a range of modules for 3rd party sensors and general instrumentation tasks that expand the Orbit® Digital Measurement System for applications that are not just linear measurement.

The **Analogue Input Module (AIM)** allows the Orbit® network to be interfaced with a wide range of sensors that have current or voltage output. Typical sensors that may be connected are:

- ▶ Force sensors
- ▶ Load Cells
- ▶ Pressure sensors
- ▶ PT100 Temperature sensors

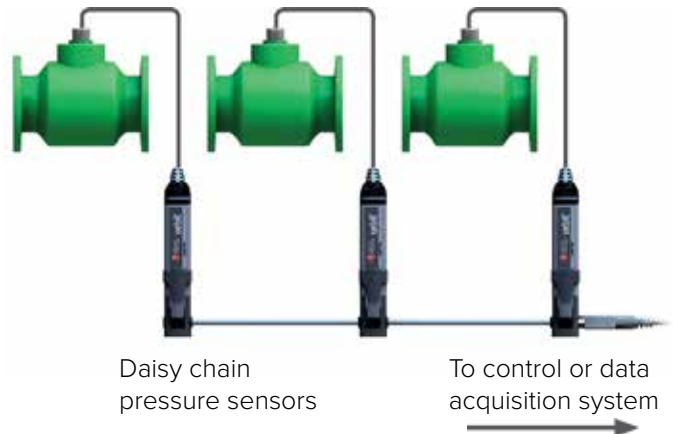

Applications include: Combining linear measurements using probes with air gauging via an AIM, temperature monitoring of parts or environment. The 4-20 mA input is especially useful where the sensor is a distance from the AIM, since the signal is current and does not suffer from voltage drop over long cabling.

The **Encoder Input Module (EIM)** provides a simple interface to incremental rotary encoders or linear encoders. This is especially useful when building machines to measure parts like CAM Shafts, making profiling easy to achieve. The EIM can also be used as the controller for high speed data collection where it is critical to synchronise measurements with position on a rotating part.

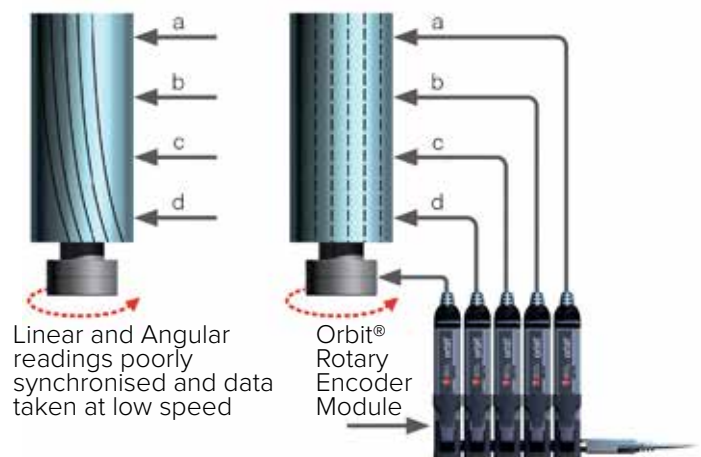











The **Digital Input/Output Module (DIOM)** allows the Orbit® network to interface with discrete inputs, such as micro switches or proximity sensors which can be used to trigger a set of measurements. The output signals from the DIOM can be used interface to external components like relays or indicators to control a process or indicate a measured part is in or out of tolerance.

**Strain Gauge Input Module (SGIM)** is designed to connect to any common strain gauge

**Digimatic Input Module (DIM)** is designed to connect to any Digital gauge with a Digimatic Output, allowing hand tools to be integrated into the Orbit® Network.

# Technical Specifications

	AIM		EIM	DIOM	DIM	STRAIN GAUGE
	 		 	 	 	 
Input Type	Analogue	Temperature	Pulse (TLL)	Discrete	DIM	Voltage (mV)
Typical Input	Load cells, temperature transducers, airgauge	PT100	Incremental Rotary or Linear Encoder	Switch	Digimatic Transducer	Strain Gauge
Standard Input Range	±10 V, ±5 V, 0-10 V, 4-20 mA	-50 °C to 250 °C, -50 °C to 850 °C, -20 °C to 70 °C	30 V @ 10 mA	30 V @ 1 mA	As per transducer	10 range 3.2 - 399 x (313 - 2.95 mV)
Linearity (%FSO)	0.05	0.01	N/A	N/A	N/A	N/A
Input Frequency	460 Hz	460 Hz	1.2 MHz	N/A	N/A	DC
Input Channels	1	1	1	8	1	1
Output Range	N/A	N/A	N/A	Discrete Drive up to 30 V @ 5 mA	N/A	N/A
Measurement Modes	All	All	All	All	Static	All
Readings per second	3906	3906	3906	3906	Readings on request	3906
Nominal Power Requirement mA @ 5 V (No Load)	78	78	49	42	49	122

**ATM TTL Converter:** TTL RS422 is one of the most commonly used methods of communicating between Linear displacement sensors and Control or data Acquisition systems. Most sensors which offer this are incremental sensors and can lose position if moved too quickly. Solartron ATM is an absolute system and can never lose position even if power is interrupted.

Transducer	All Solartron Transducers
Resolution (µm)	0.1
Power	+5 ±0.25 VDC @ 100 mA
Output Signals	A and B, /A and /B TTL Square Wave RS422 levels
Frequency (kHz)	50, 100, 125, 250 and 500 (factory selectable)
Bandwidth (Hz)	100
Sealing	IP43







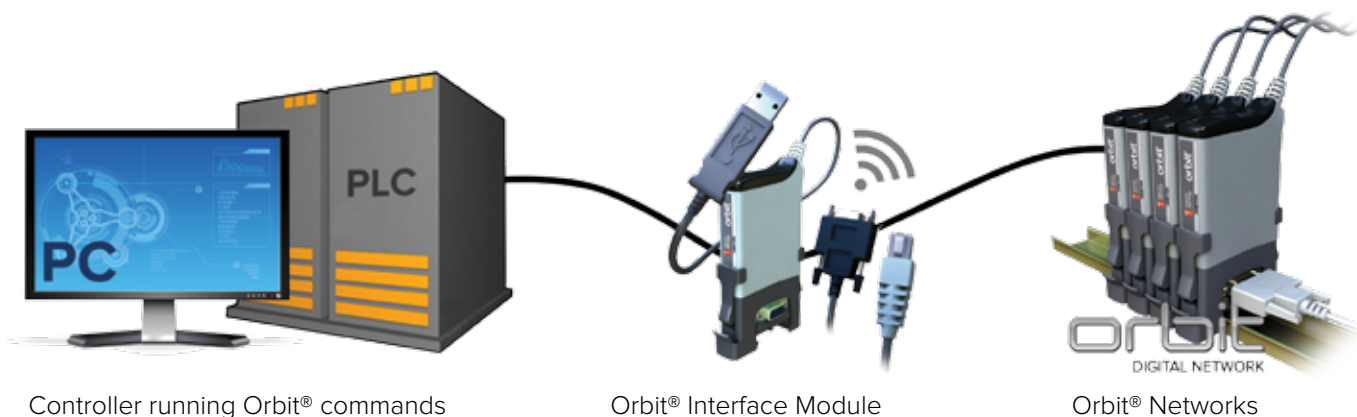

# Orbit® Interface Modules and Orbit® to PLC Gateways

Whether it be PC, laptop or PLC, Solartron offers a range of Interface Modules and PLC gateways for directly connecting to an Orbit® Network with the Controller of your choice.

The interface module provides a method of connecting controllers to the Orbit® network where the controller itself runs the network. The interface module simply translates and retransmits the Orbit® commands between the Network and the Controller.



	USBIM	ETHIM	RS232	WIM
				
				
Interface	USB 2.0	Ethernet	RS232	Bluetooth™
Data Rate (max) Baud	12 Mbps	10/100 Mbps	115.2 Kbps	3 Mbps
No. of Modules	150	150	150	150
No. of Module powered (Note 1)	4	0	0	0
Orbit® Measurement Modes	All	Static, Readburst	Static, Readburst	Static, Readburst
Readings per second (Note 2)	3906 (max)	300 (typical)	150 (typical)	25 (typical)
Nominal Power Requirement mA @ 5 V (No load)	250	350	62	120

- ▶ Note 1: The USB controller can power up to 4 Orbit® Modules of most types  
Some products require additional power supply modules
- ▶ Note 2: Readings per second per sensor for up to 16 modules

# Orbit® PLC Interface Modules





The PLC Gateway module provides a method of connecting PLC controllers to the Orbit® network data. The PLC Gateway runs the Orbit® network, takes data from the network and stores it in such a way that the PLC controller can access the data. With these gateways, the PLC does not need to handle the Orbit® Protocol.



PLC (Programmable Logic Controller)

PLC Gateway

Orbit® Network

	MODIM	PIM	
			
			
Protocol	MODBUS RTU	EtherNet/IP	PROFINET
Data Rate (max) Baud	115.2 Kbs	12 Mbps	12 Mbps
No. of Modules	150	150	150
No. of Module powered (Note 1)	0	10	10
Access Method	RTU	Cyclic or Explicit	TBA
Readings per second	Depends on PLC		
Input Voltage	+5 VDC	+24 VDC	+24 VDC

► Note 1: The PIM controller can power up to 10 Orbit® Modules of most types  
Some products require additional power supply modules

# Orbit® Digital Readouts

Solartron has a range of digital readouts to suit all applications from industrial panel mount to desk top units. Readouts can have from 1 to 31 channels of measurement and can be configured for custom applications.

Product	No of Channels	I/O	Comms	Functions
SI100	1	Yes	Yes	Pre Programmed
SI200	2	Yes	Yes	Pre Programmed
SI400	4	Yes	Yes	Pre Programmed
SI3500	2	Yes	Yes	Pre Programmed
SI5500	31	Yes	Yes	Programmable

All of Solartron readouts work with all of Solartron Digital Transducers and Non-Contact Sensors, the performance of these sensors is not degraded in any way when used with the readouts.

## SI100, SI200 and SI400

The SI100 is a single channel, stand alone system, while the SI200 also connects to an Orbit® probe for two channel measurements and the SI400 connects to up to 3 probes.

### Features

- ▶ Integral Readout with colour LCD Screen and keypad
- ▶ Set tolerance and process limits via keypad
- ▶ Detachable probe plug on housing for easy installation
- ▶ Replace probe with no calibration or reprogramming
- ▶ Modbus output (RTU) over RS485 or RS232
- ▶ Programmable discrete I/O (4 inputs, 3 outputs)
- ▶ Multiple formulas available for SI200 (A+B, A-B, etc)
- ▶ Available with all Solartron transducers and lasers
- ▶ 24 VDC Power Supply



## SI3500 and SI5500 Readouts

Specially designed to work with Solartron Orbit® Digital Transducers, the SI3500 and SI5500 provide the user with solutions for small systems. Both readouts have intuitive menu systems for ease of set up and can be programmed to display readings, alarms, limits and other metrology functions. With discrete I/O and serial interfaces these readouts provide a neat solution to interface to other systems like PLC's.

### Features

- ▶ Intuitive menu
- ▶ Accepts up to 31 Orbit® Sensors (SI5500)
- ▶ Suite of Mathematical Functions for each channel
- ▶ Auto colour change for in/out limit range
- ▶ User selectable bar panel or text display
- ▶ Auto course / fine resolution
- ▶ Gauging Mode
- ▶ Peak hold facility
- ▶ Data logging facility
- ▶ RS232 Connectivity
- ▶ 0.01 µm display resolution
- ▶ Available for Digital probes, Linear Encoders, Encoder Input modules and laser sensors
- ▶ Discrete I/O



SI5500 can connect to up to 31 Orbit® modules



# Technical Specifications

SI100, 200 and 400 Standard Options			x=100, 200, 400				
Actuation	Cable	Type	Description				
Spring Push	Axial	Standard	SlxP/1/S	SlxP/2/S	SlxP/5/S	SlxP/10/S	SlxP/20/S
	Axial	Feather Touch	SlxT/1/S	SlxP/2/S	SlxP/5/S	SlxP/10/S	SlxP/20/S
Pneumatic	Axial	Standard	SlxP/1/P	SlxP/2/P	SlxP/5/P	SlxP/10/P	SlxP/20/S
	Axial	Feather Touch	SlxT/1/P	SlxT/2/P	SlxT/5/P	SlxT/10/P	SlxT/20/S
<b>Performance and Functions</b>							
Measuring Range for Integral Probe (mm)			1	2	5	10	20
Performance			See Digital Probe Specification on Page 16				
No. of Measurement Channels			SI100 Channel A, SI200 Channel A, B, SI400 Channels A, B, C and D				
<b>Measurement Modes</b>		SI100	A, MAXA-MINA				
		SI200	A, B, A+B, A-B, (A+B)/2, MAXA-MINA MAXB-MINB				
		SI400	A, MAXA-MINA, B, MAXB-MINB, C, MAXC-MINC, D, MAXD-MIND				
Measurement Units			mm, inches, mils				
Measurement Types			Absolute, Zero, Preset, Track, (Peak + and Peak - SI100/200)				
LCD Colour Display			Digital Measurement and Analogue Bar				
Keypad			Membrane				
Discrete Inputs			4 User Programmable				
Discrete Outputs			3 User Programmable				
Serial Communications			Modbus RTU or Solartron ASCII protocol				
<b>Performance and Functions</b>			<b>SI3500</b>		<b>SI5500</b>		
Number of Transducers			1 or 2		1 to 31		
Display			1 or 2 Channels		Up to 16 Channels		
Length / Resolution			±xx.xxxxx (mm) ±xx.xxxxx inches		±xx.xxxxx (mm) ±xx.xxxxx inches		
Indications			mm / inch, Lower and Upper Limits, Out of Range, Measurement Type and Mode				
Keypads			Print, Zero, Preset, Peak, Hold Track, Menu				
Measurement Type Data Logging			A, B, A+B, (A+B)/2, (A+B)2, (B+A)/a 10,000 readings via discrete inputs or 1 ms to 24 hour time interval		User programmable with multiple 8 pages of data with 4000 readings per channel per page data triggered by discrete input of timed 1 ms to 25 hours		
<b>Input and Outputs</b>							
Orbit® Interface			Yes		Yes		
Serial ACSII Interface			Yes		Yes		
Inputs			Six isolated		Six isolated - user configurable		
Outputs			Six isolated		Six isolated - user configurable		
Analogue Output			2 User selectable Voltage or 4-20 mA		None		
<b>Power and Environmental</b>							
Operating Voltage			24 VDC ± 10%				
Power for Transducers			5 VDC up to 2 transducers		5 VDC up to 31 transducers		
Sealing Front Panel			IP65				
Sealing Case			IP51				
Sealing Rear Connections			IP51				
Operating Temperature (°C)			5 to 50				
Storage Temperature (°C)			-20 to 50				
EMC			Immunity EN61000-6-2 Emissions EN61000-6-3				
<b>Mechanical</b>							
Mounting			Bench or Panel		Bench or Panel		
Dimensions WxHxD			Without bezel 132x67x160 / With Bezel 144x76x177				

# Transducer Tips

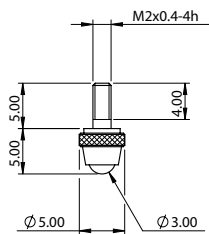

**Ø3.00 mm Ball**

Tip Material	Part no.
T. Carbide	806341
Ruby	807428
Nylon	807429
Silicon Nitride	807430

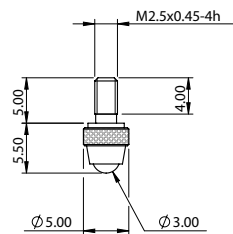

**Ø3.00 mm Ball**

Tip Material	Part no.
T. Carbide	804979
Ruby	804807
Nylon	805181
Silicon Nitride	804973

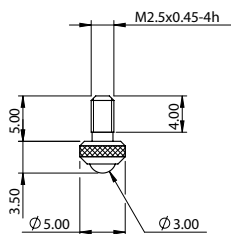

**Ø3.00 mm Ball**

Tip Material	Part no.
T. Carbide	802605
Ruby	807431
Nylon	803246
Silicon Nitride	807432

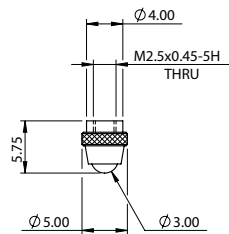

**Ø3.00 mm Ball**

Tip Material	Part no.
T. Carbide	804967
Ruby	804966
Nylon	804965
Silicon Nitride	805180

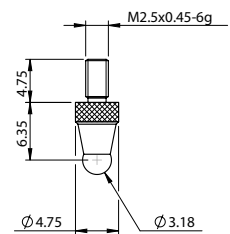

**Ø3.18 mm Ball**

Tip Material	Part no.
T. Carbide	008305-004

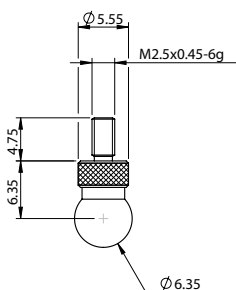

**Ø6.35 mm Ball**

Tip Material	Part no.
T. Carbide	008305-005

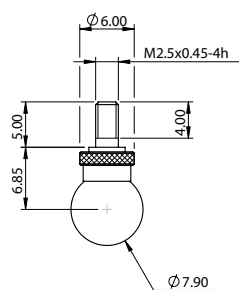

**Ø7.9 mm Ball**

Tip Material	Part no.
Ruby	804828

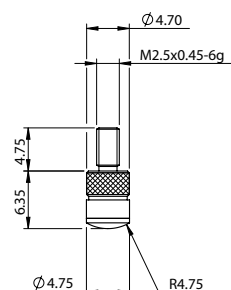

**Ø4.75 mm Dome**

Tip Material	Part no.
T. Carbide	008305-034

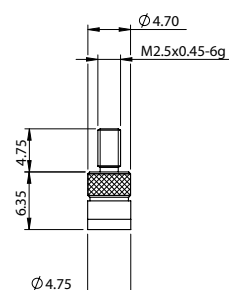

**Ø4.75 mm Flat**

Tip Material	Part no.
T. Carbide	008305-033

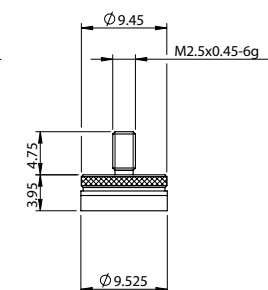

**Ø9.52 mm Flat**

Tip Material	Part no.
T. Carbide	008305-007

**90° Sharp Point**

Tip Material	Part no.
T. Carbide	008305-003

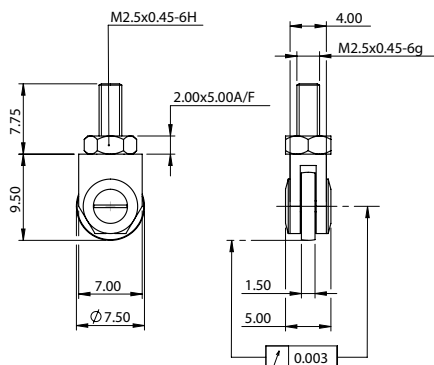

**1.5 x 7.5 mm Wheel**

Tip Material	Part no.
Steel	008305-027

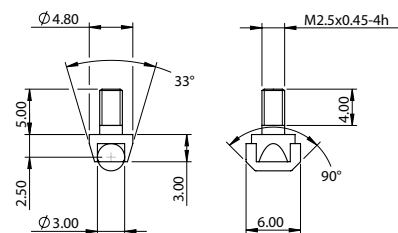

**Ø3.0 mm Roller**

Tip Material	Part no.
T. Carbide	209193



# Transducer Tips

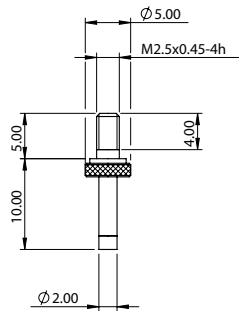

**Ø2.0 mm Pin**

Tip Material	Part no.
T. Carbide	206675

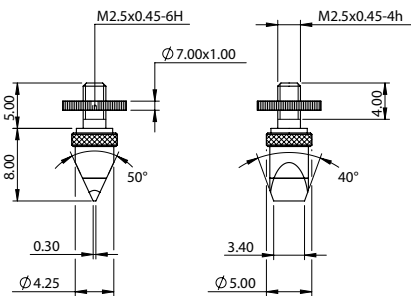

**Knife Edge**

Tip Material	Part no.
T. Carbide	206674

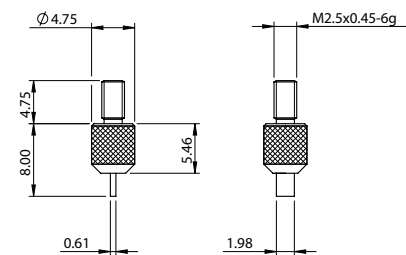

**0.6 x 2 mm Blade Edge**

Tip Material	Part no.
T. Carbide	008305-035

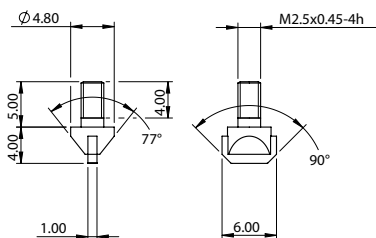

**1 x 6 mm Blade Edge**

Tip Material	Part no.
T. Carbide	209194

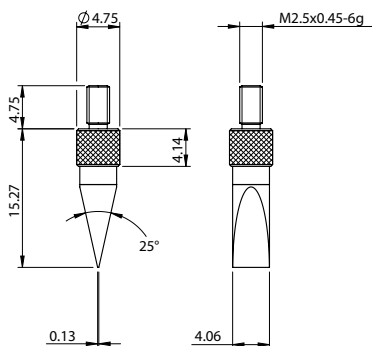

**4 x 11 mm Knife Edge**

Tip Material	Part no.
T. Carbide	008305-036

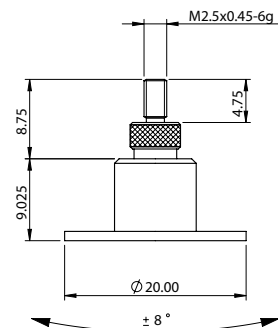

**Floating Tip**

Tip Material	Part no.
Steel	807434

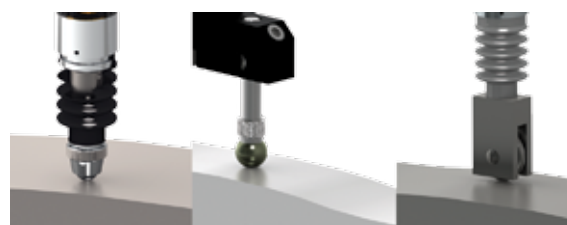

Ball Tips

Wheel tip

Contact size, shape and material are critical to ensure accurate measurements, for example a flat or knife tip makes measuring external diameters much simpler than using a point tip as probe alignment is not as critical. Tungsten carbide is a good general purpose material while ruby offers longer life. Silicon Nitride is good for aluminium as tungsten carbide can mark aluminium parts.

# Orbit® Transducer Dimensions

## Standard Spring Push (DP/S)

	DP/2/S	DP10/2/S	DP/5/S	DP/10/S	DP/20/S
<b>A</b>	47.50	75.00	66.50	90.50	127.00
<b>C</b>	2.00	4.00	2.00	2.00	3.00
<b>B1</b>	14.25	25.50	18.00	25.50	45.00
<b>B2</b>	11.25	14.50	12.00	14.50	24.00
<b>D</b>	33.50	61.50	52.50	76.50	113.50

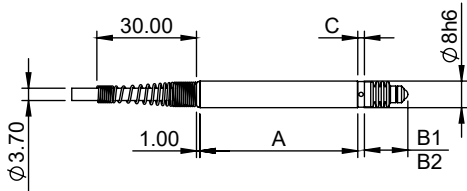

## Feather Touch Spring Push (DT/S)

	DT/2/S	DT/5/S	DT/10/S	DT/20/S
<b>A</b>	47.50	66.50	90.50	127.00
<b>C</b>	2.00	2.00	2.00	3.00
<b>B1</b>	14.25	18.00	25.50	34.00
<b>B2</b>	11.25	12.00	14.50	13.00
<b>D</b>	33.50	52.50	76.50	113.50

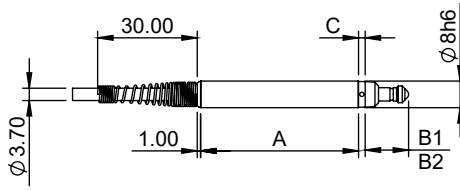

## Radial Cable Outlet Plastic Adapter

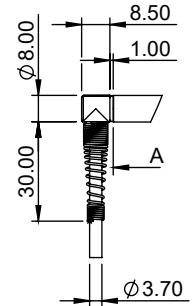

## Pneumatic Push (DP/P)

	DP/2/P	DP10/2/P	DP/5/P	DP/10/P	DP/20/P
<b>A</b>	52.50	84.00	71.00	96.00	127.00
<b>C</b>	2.00	2.00	2.00	2.00	3.00
<b>B1</b>	14.25	25.50	18.00	25.50	45.00
<b>B2</b>	11.25	14.50	12.00	14.50	24.00
<b>D</b>	38.50	70.50	57.50	82.50	113.50

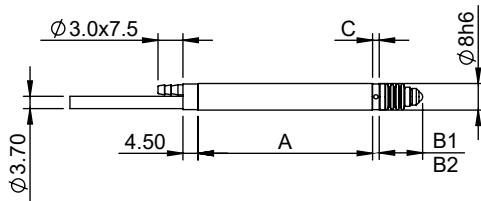

## Feather Touch Pneumatic Push (DT/P)

	DT/2/P	DT/5/P	DT/10/P	DT/20/P
<b>A</b>	52.50	71.00	96.00	127.00
<b>C</b>	2.00	2.00	2.00	3.00
<b>B1</b>	14.25	18.00	25.50	34.00
<b>B2</b>	11.25	12.00	14.50	13.00
<b>D</b>	38.50	57.50	82.50	113.50

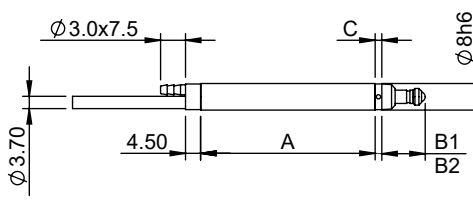

## Radial Cable Outlet Fixed / Spring Push

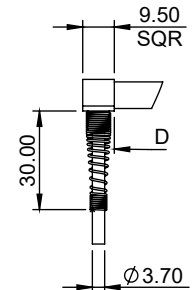

## Vacuum Retract (DP/V)

	DP/2/V	DP/5/V	DP/10/V	DP/20/V
<b>A</b>	47.50	66.50	90.50	127.00
<b>C</b>	2.00	2.00	2.00	3.00
<b>B1</b>	14.25	18.00	25.50	45.00
<b>B2</b>	11.25	12.00	14.50	24.00
<b>D</b>	33.50	52.50	76.50	113.50

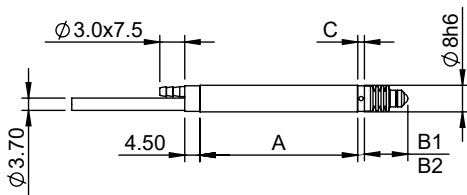

## Gaiger Independent Pneumatic (DJ/P)

	DJ/2/P	DJ/5/P	DJ/10/P	DJ/20/P
<b>A</b>	52.50	71.00	96.00	127.00
<b>C</b>	7.00	7.00	7.00	4.00
<b>B1</b>	16.25	20.00	27.50	46.00
<b>B2</b>	13.25	14.00	16.50	25.00
<b>D</b>	38.50	57.50	82.50	113.50

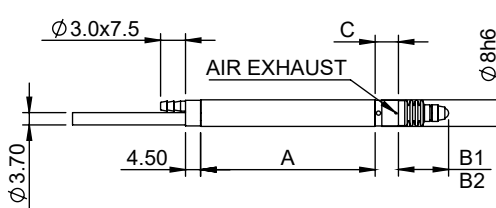

## Radial Cable Outlet Fixed / Pneumatic Push

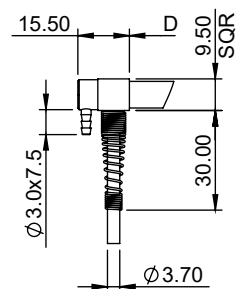

## Ultra Feather Touch Spring Push (DW/S)

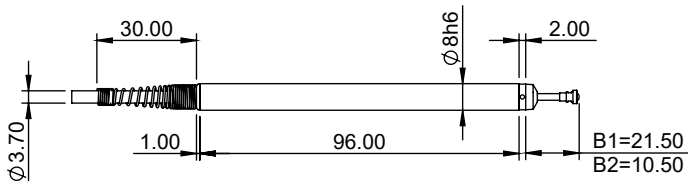

## Ultra Feather Touch Pneumatic Push / Vacuum Retract (DW/P & DW/V)

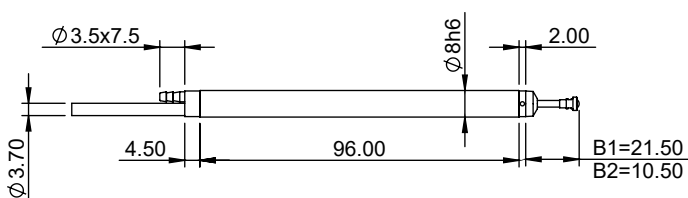

- A** - Case length for axial cable outlet
- B1** - Fully extended bearing assembly
- B2** - Fully retracted bearing assembly
- C** - Fixed part
- D** - Case length for radial cable outlet

# Orbit® Transducer Dimensions

## Ultra Short Spring Push (DZ/S)

	DZ/1/S	DZ/2/S	DZR/1/S	DZR/2/S
A	15.00	19.50	11.00	15.50
B1	5.15	6.25	5.15	6.25
B2	3.65	3.65	3.65	3.65

## Axial Cable Outlet (DZ/S)

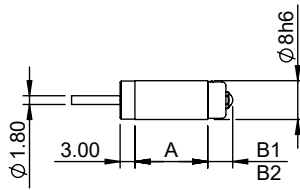

## Radial Cable Outlet (DZR/S)

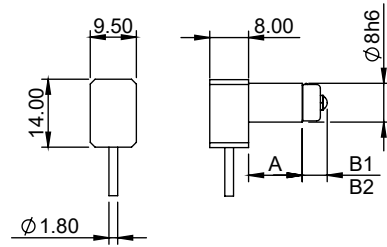

## Miniature Spring Push (DP/0.5/S & DP/1/S)

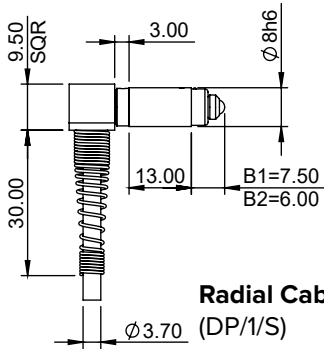

Radial Cable Outlet (DP/1/S)

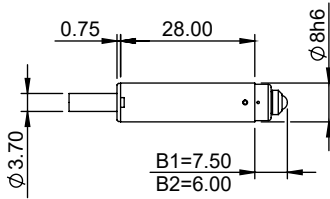

Axial Cable Outlet (DP/1/S)

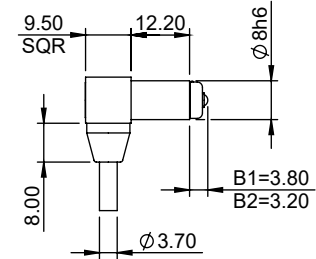

Radial Cable Outlet (DP/0.5/S)

## 6 mm Diameter Body Spring Push (D6P/S)

	D6P/2/S	D6P/5/S
A	50.00	74.00
B1	14.30	29.50
B2	11.80	23.50

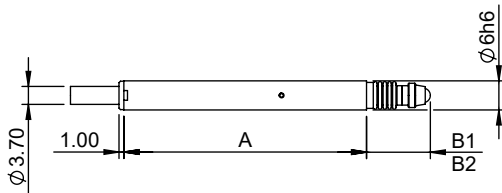

## 6 mm Diameter Body Gaiter Independent Pneumatic (D6J/P)

	D6J/2/P	D6J/5/P
A	50.00	80.00
B1	14.00	30.00
B2	11.00	24.00

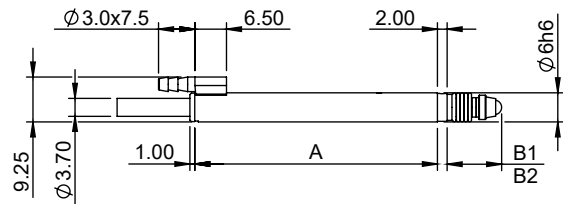

## Lever Probe (DL)

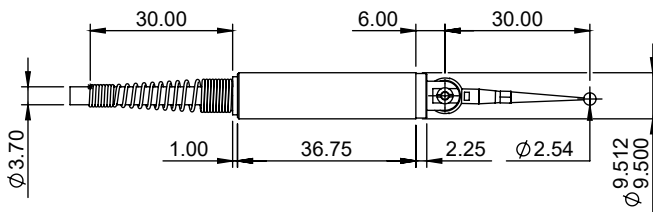

## 3 mm Diameter Body (D3P/S)

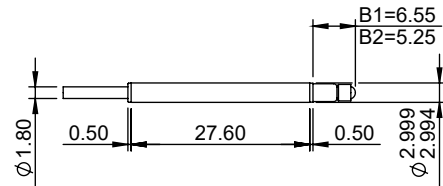

## Mini Probe (DM)

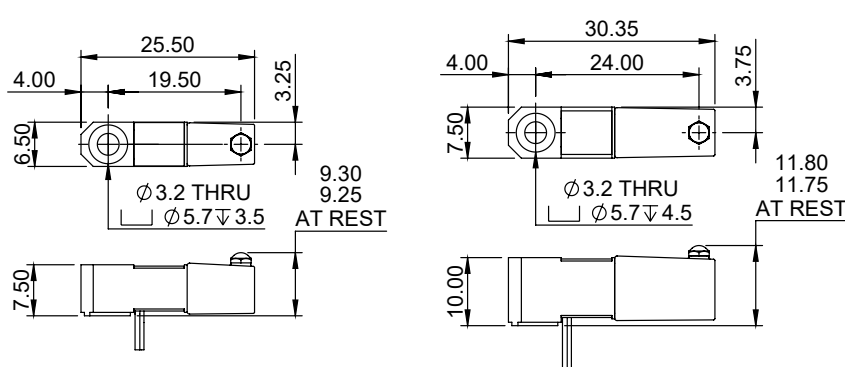

(DM/0.5/S)

(DM/1/S)

## Mini Single Leaf Flexure (DUSM)

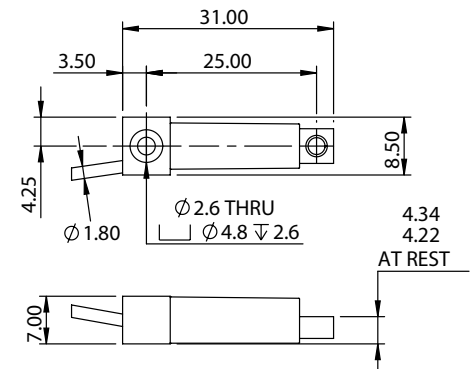

(DUSM/0.5/S)

# Orbit® Transducer Dimensions

**Flexure Gauge (DU(R)/1/S(P))**

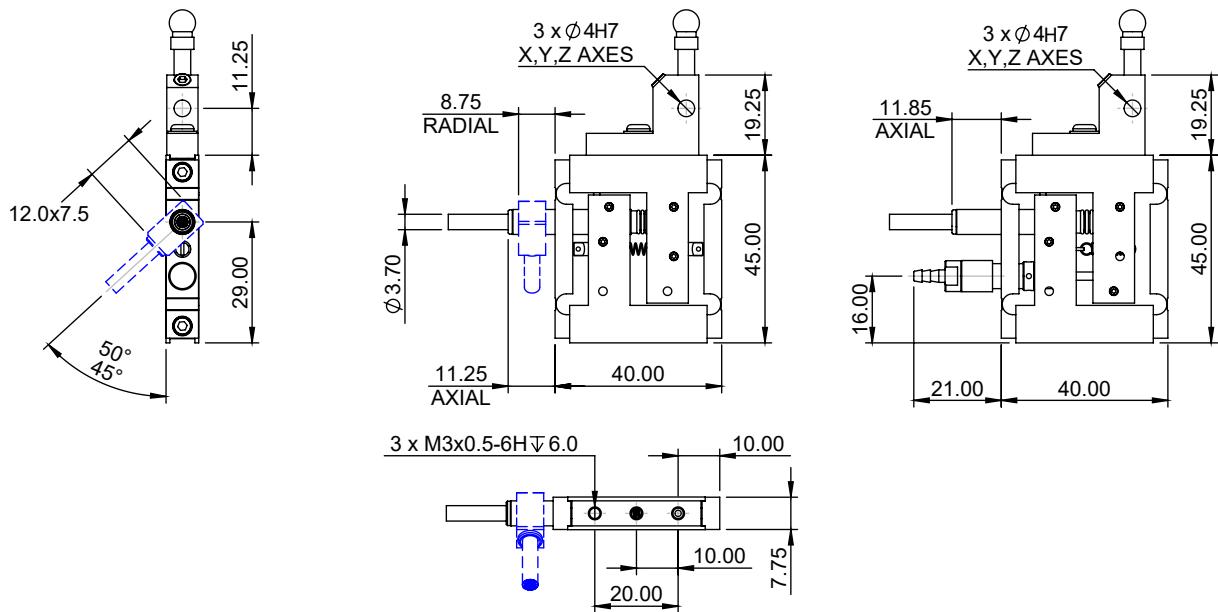

**Flexure Gauge (DU(R)/2/S(P))**

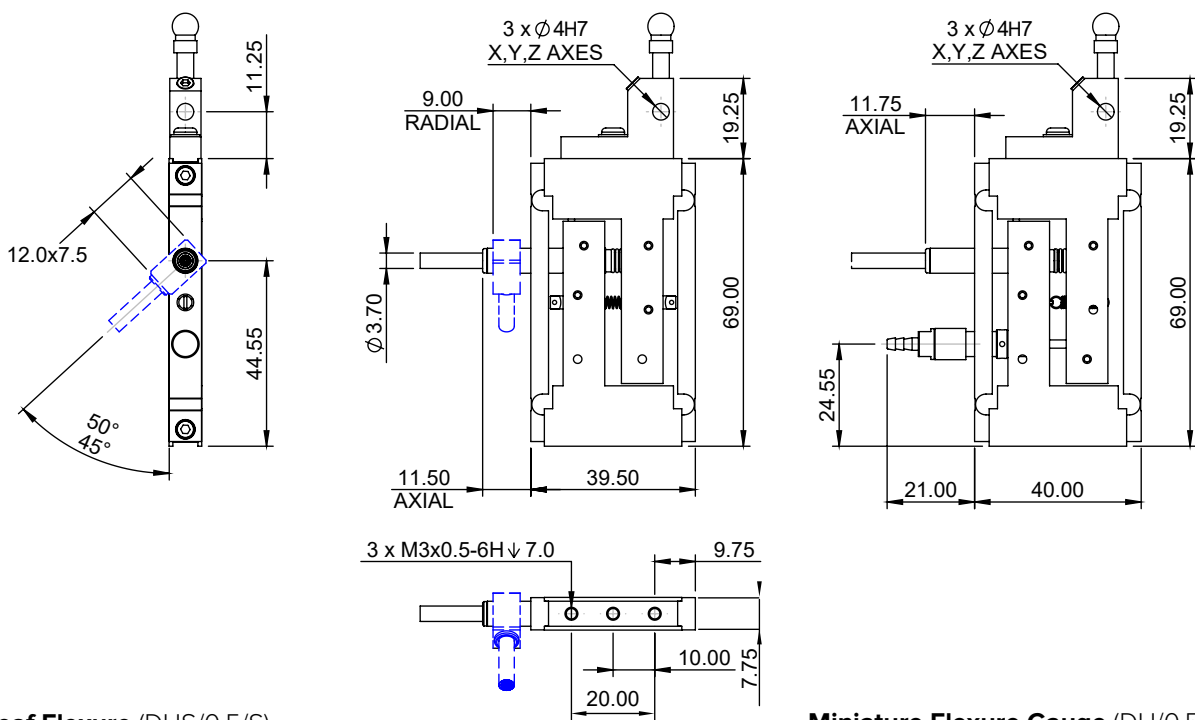

**Single Leaf Flexure (DUS/0.5/S)**

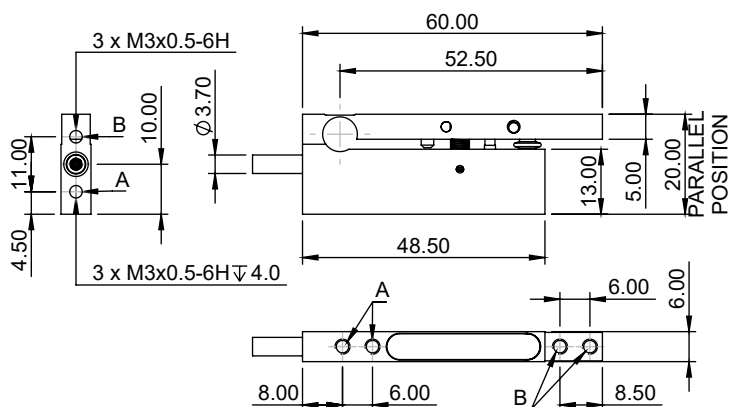

**Miniature Flexure Gauge (DU/0.5/S)**

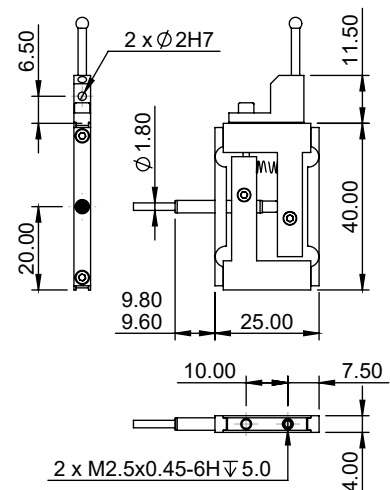

# Orbit® Transducer Dimensions

**Block Gauge (DK(R)/2/S(P))**

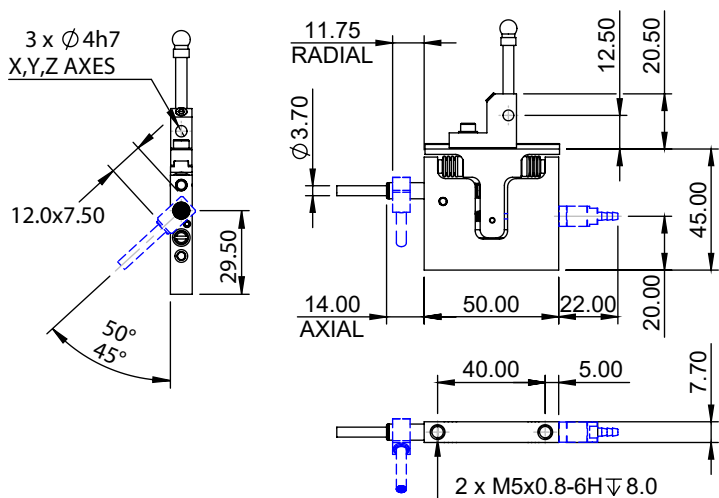

**Orbit® Confocal**

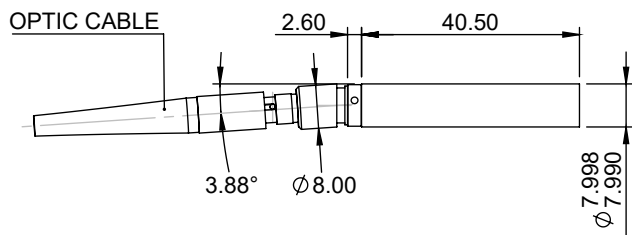

**Robust Block Gauge (DK(R)/5/S(P))**

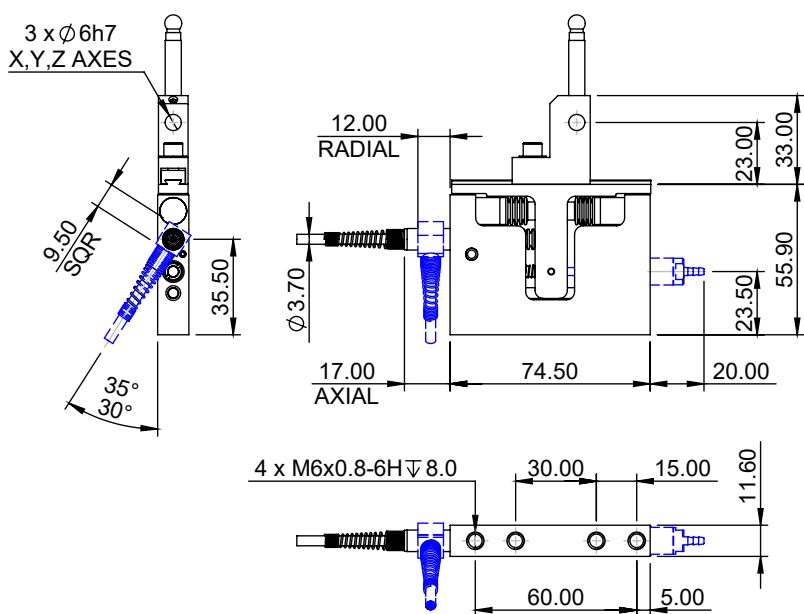

**Orbit® LTH**

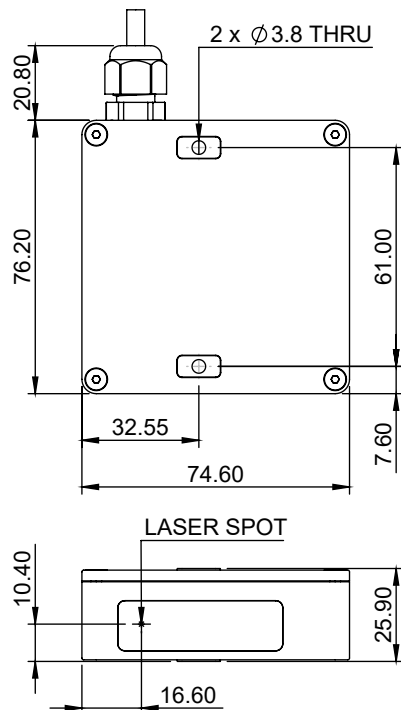

**Robust Block Gauge (DK(R)/10/S(P))**

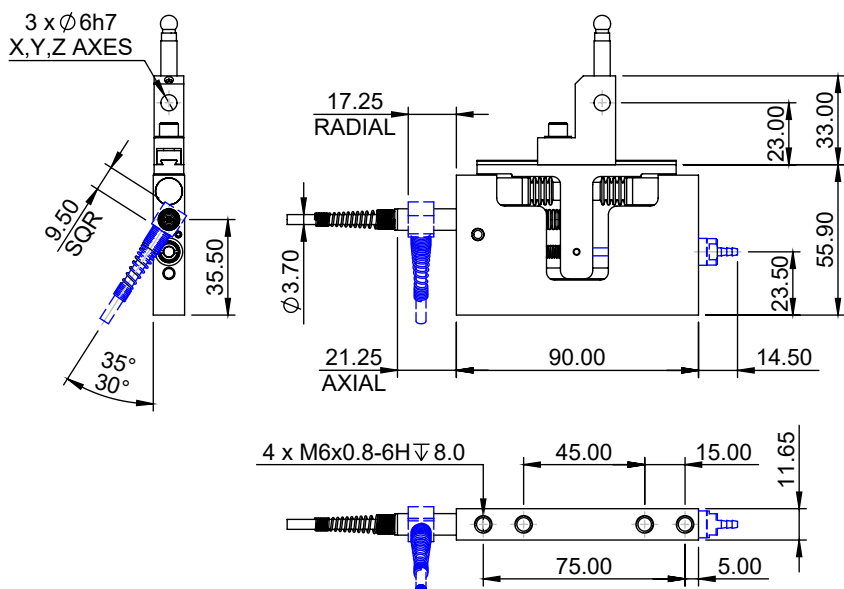

**Orbit® LT**

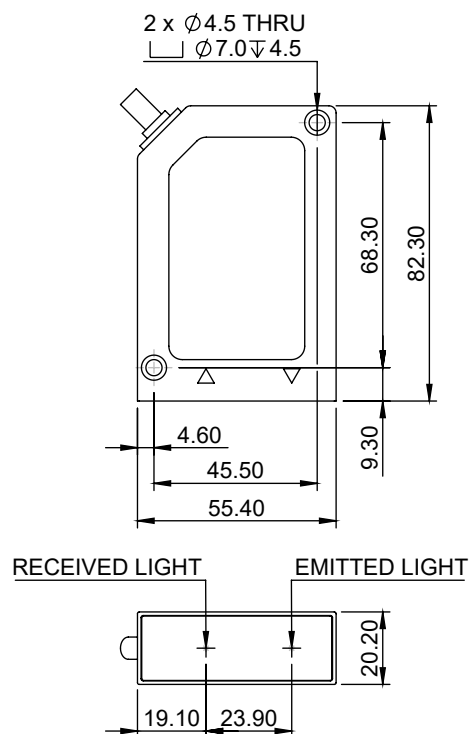

# Orbit® Dimensions

## Orbit® T-Con Construction

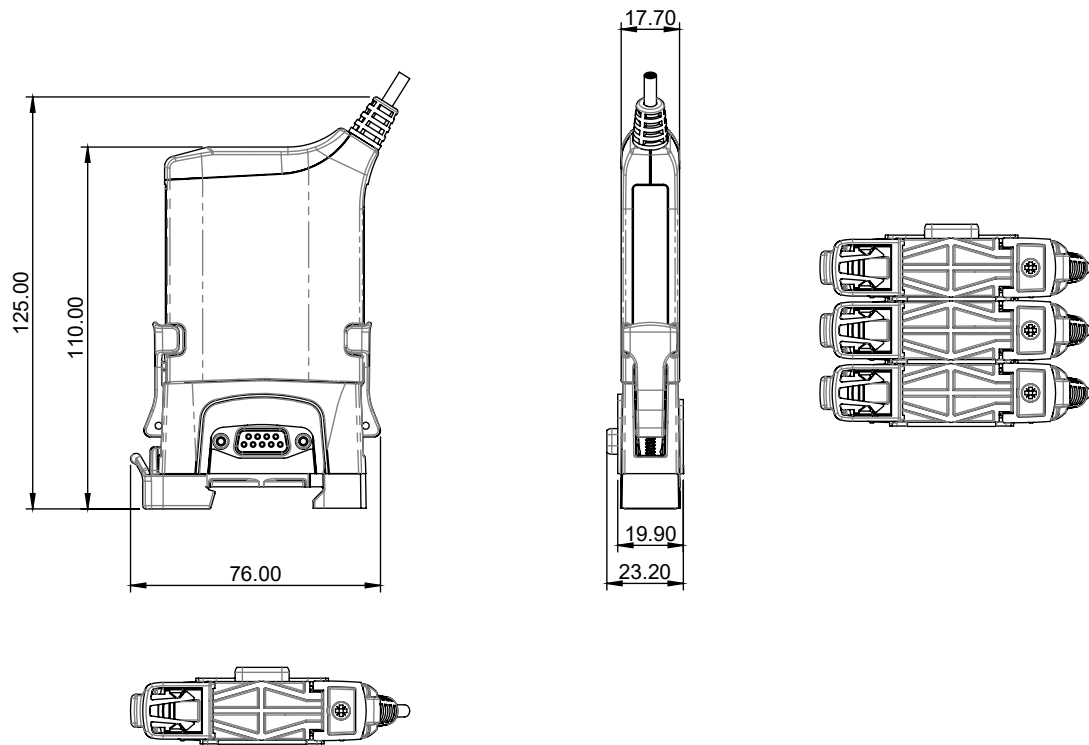

## ACS T-Con Construction

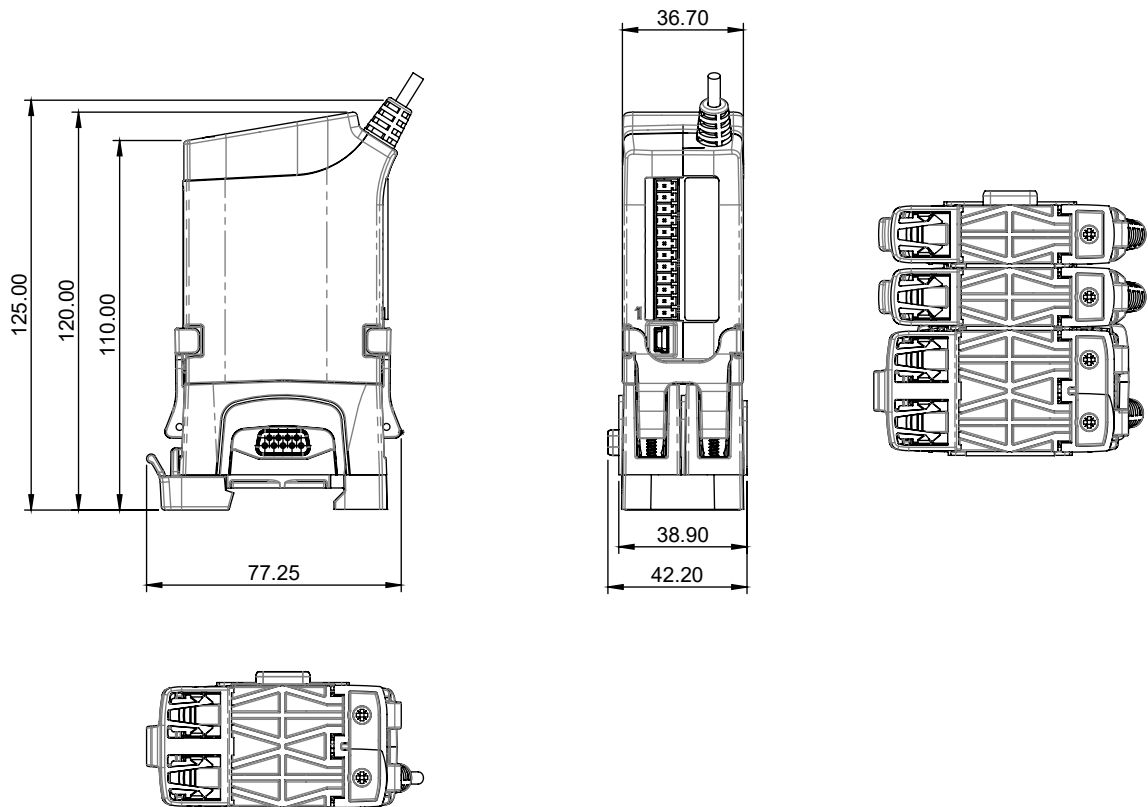

# Glossary

## Glossary of terms, Sensors

### Accuracy, Precision and Repeatability

- ▶ A sensor has limited use if a measured value cannot be accurately repeated.
- ▶ A sensor can be considered to be Precise in that its measured values are repeatable.
- ▶ A sensor can produce precise yet inaccurate readings.



Precise but not accurate

Accurate but not Precise

To be of true value, linear measuring sensors need to be both Accurate and Precise. Orbit® Digital Sensors are very linear over their full range, and are therefore accurate. They have excellent repeatability, and are therefore precise.

### Accuracy

The accuracy of all Solartron Metrology Digital Sensors is quoted as % of reading, which is the method that is least open to interpretation (as opposed, for example, to best fit).

### Repeatability

Repeatability is defined as the ability of a sensor to provide measurements within a close distribution on the same measure and carried out in the same direction. Solartron uses a method of establishing repeatability where a side load is applied in four directions to reflect how sensors are used in most applications. Methods of establishing repeatability without applying a side load may produce better results but may not be representative of real life applications.

## Glossary of terms, Orbit®

### Orbit® Module

A module that can be connected to the Orbit® System as part of a Network Channel. Modules perform various measurements and interface to the external world.

### Orbit® Interfaces and Gateways

Hardware that controls a network of modules and is used to provide a communication path between a PC or PLC and the Orbit® network.

### Orbit® Channel

A channel of an Orbit® Controller that is capable of supporting a network of modules. Channels are numbered either Channel 1 or Channel 2. (Channel 2 only exists depending on type of controller.)

### PIE

Probe Interface Electronics

### T CON

A 3 way connector containing a chip (E PROM) to provide the address of a sensor or module in the Orbit® Network.



# Sales Offices

## UK (Headquarters and Factory)

Solartron Metrology  
Bognor Regis, West Sussex, PO22 9ST  
Tel: +44 (0) 1243 833 333  
Fax: +44 (0) 1243 833 332  
Email: sales.solartronmetrology@ametek.com

## France

AMETEK SAS  
Solartron Metrology Division  
Elancourt, 78990 France  
Tel: +33 (0) 1 30 68 89 50  
Fax: +33 (0) 1 30 68 89 99  
Email: info.solartronmetrology@ametek.com

## Germany

AMETEK GmbH  
Solartron Metrology Division  
40670 Meerbusch  
Tel: +49 (0) 2159 9136 500  
Fax: +49 (0) 2159 9136 505  
Email: vertrieb.solartron@ametek.com

## Brazil

AMETEK do Brasil, Ltda  
Rod. Eng Ermenio de Oliveira Penteadou, Km 57, SP75  
Bairro Tombadouro  
13337-300, Indaiatuba, SP, Brasil  
Tel: +55 19 2107 4126

## China

AMETEK Commercial Enterprise (Shanghai)  
Co., Ltd  
Shanghai, 200131, China  
Tel: +86 21 5763 2509  
Email: china.solartronmetrology@ametek.com

## North America

Solartron Metrology  
USA Central Sales Office  
Gastonia, NC 28054  
Tel: +1 800 873 5838  
Email: usasales.solartronmetrology@ametek.com

## Distributors

Solartron have 30+ distributors worldwide, see website [www.solartronmetrology.com](http://www.solartronmetrology.com) for your nearest distributor

## Precision Driven...

In the laboratory, on the shop floor or in the field, Solartron Metrology's products provide precise linear measurements for quality control, test and measurement and machine control. Solartron Metrology is a world leader in the innovation, design and manufacture of precision digital and analogue dimensional LVDT gauging probes, displacement sensors, optical linear encoders and associated instrumentation.



Solartron Metrology pursues a policy of continuous development. Specifications in this document may therefore be changed without notice.