

QM-DATA200 AND VISION UNIT

Extending the Capabilities of 2D Optical Measuring Instruments

OPTICAL MEASURING

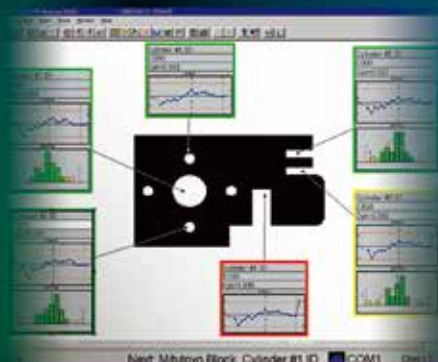
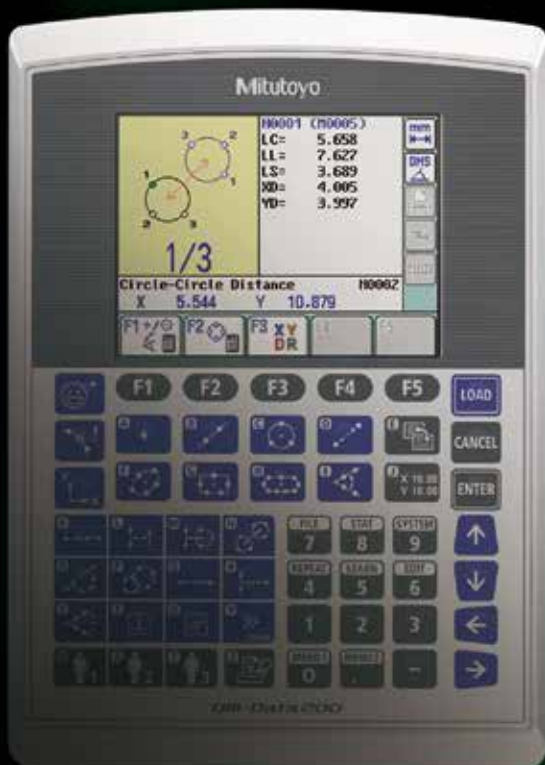

Powerful support for measurement and

Amid the constant advancement of today's industrial world, the importance of an optical measuring machine that allows the non-contact measurement of workpiece dimensions is increasing, along with the growth of processing technology.

At the same time, as more rationalization and less manpower are required on the shop floor, the factors of efficiency, speed and reliability are becoming more important with respect to measurement.

Mitutoyo's optical measurement data-processing systems, the QM-Data200 and vision measurement unit answer these needs as well as supporting the all-important Quality Assurance function.

Choose the one that best suits your requirements.

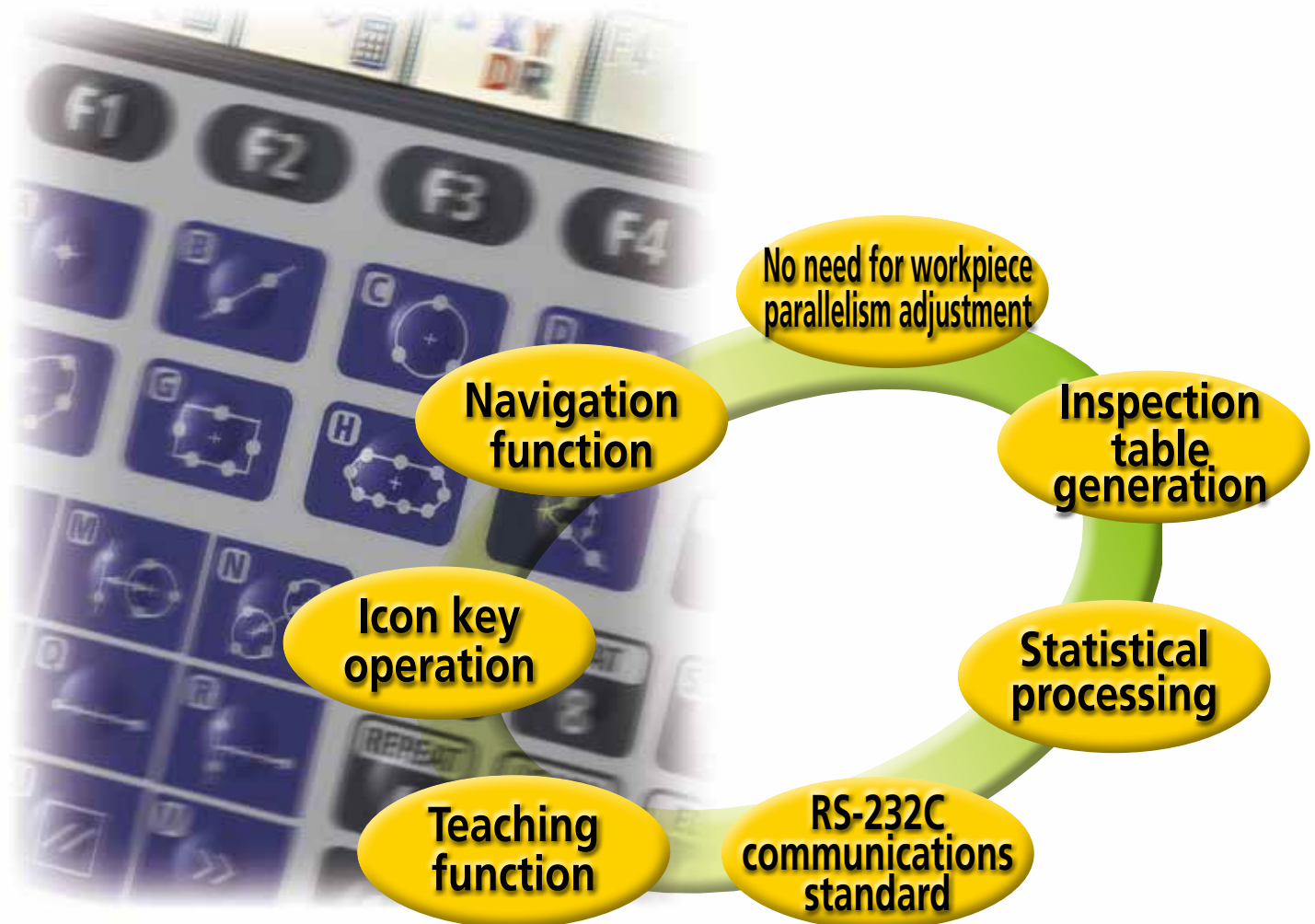

QA

Labor-saving data processing and transfer

No need for parallelism adjustment of a workpiece on the stage

Merely setting a part coordinate system on a workpiece allows you to start measurement without extra operations. There is no need to make a parallelism adjustment of the workpiece using a rotary table.

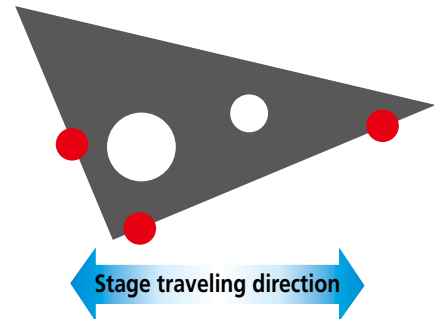

Easy transfer of counter display values and measurement result to a PC

The user can transfer counter display values to spreadsheet software on the PC, output a calculation result with the data processing system to the PC to create an inspection certificate and maintain measurement history records.

QM-Data200



Vision Unit

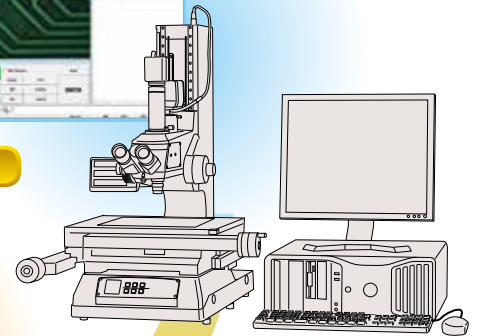
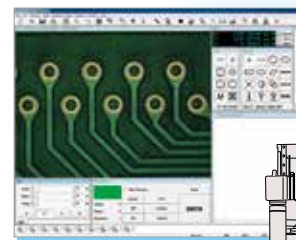

Creation of Inspection Table

Inspection Sheet					
Subject	ABC Co., Ltd.	Lot No.	LotNo.000.001		
Part No.	PART NO.001	Mass. Item	0		
Part Name	PART NAME ABC	Workpiece	0		
SKETCH:		NOTE:			
		A: 1.000 B: 2.000 C: 3.000 D: 4.000 E: 5.000 F: 6.000 G: 7.000 H: 8.000 I: 9.000 J: 10.000 K: 11.000 L: 12.000			
		M: 13.000 N: 14.000 O: 15.000 P: 16.000 Q: 17.000 R: 18.000 S: 19.000 T: 20.000			
Mass. Item No.	Item1	Item2	Item3	Item4	Item5
Mass. Item Name	Item1Name	Item2Name	Item3Name	Item4Name	Item5Name
Item1	1.000	2.500	3.000	4.000	5.000
Upper Tolerance	0.000	0.000	0.000	0.000	0.000
Lower Tolerance	-0.000	-0.000	-0.000	-0.000	-0.000
Standard Phase	0	0	0	0	0

2-D Data Processing Unit QM-Data200

FEATURES

- High-contrast color graphic displays on the large LCD screen with LCD back light.
- One-key operation for combined measurements that are often used (circle-circle distance, etc.)
- Equipped with the measurement procedure teaching function and the measuring position navigation in Repeat mode.
- Easy measurement possible in combination with visual cross-hair alignment and automatic edge detection. (Optoeye positioning function installed on a profile projector.)
- The AI measurement function (automatic identification of measuring item) eliminates switching between the measurement command keys.
- The user menu function allows the user to store measurement commands or part programs to create a customized menu.
- Tolerance zone measurement of data processing result and various statistical processing for each item are possible.
- Measurement result output to "MS-Excel®" in spreadsheet (CSV) format.*
- The measurement procedure and measurement result can be saved using the USB memory.**
- Two models are available: a stand-alone type with tilt system and a flexible-arm type that can be mounted on a profile projector.***
- Measurement possible even during printout.

* MS-Excel® is a registered trademark of Microsoft Corporation.

** Operation is not assured for all commercial USB memories. For detailed information, refer to page 9.

*** For information about applicable models, refer to Specifications on page 9.



Experience measurement with the QM-Data200

The comprehensive key panels of the QM-Data200 make it easy for any operator to use.

Measurements of combined elements such as circle-to-circle distance, etc., can be measured via one-touch operation. Furthermore, the measurement procedure navigation display, which indicates the next data entry position during a measurement, makes it possible even for a beginner to see where the next measuring position is at a glance.

Measure the distance between the centers of round holes A and B.

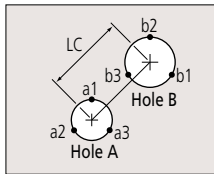

1. Select the "circle-circle distance" measurement key from the pattern-measurement keys.

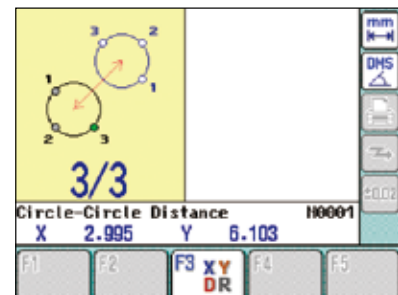

2. Measure each position (a1, a2, a3) of round hole A, following the measurement procedure navigation on the LCD.

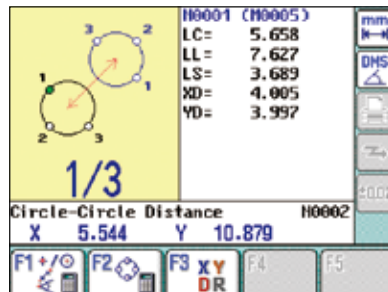

4. The measurement result is displayed.



3. Next, the measurement procedure navigation for round hole B will be displayed. Measure each position (b1, b2, b3) in the same manner as in step (2).

Key panel

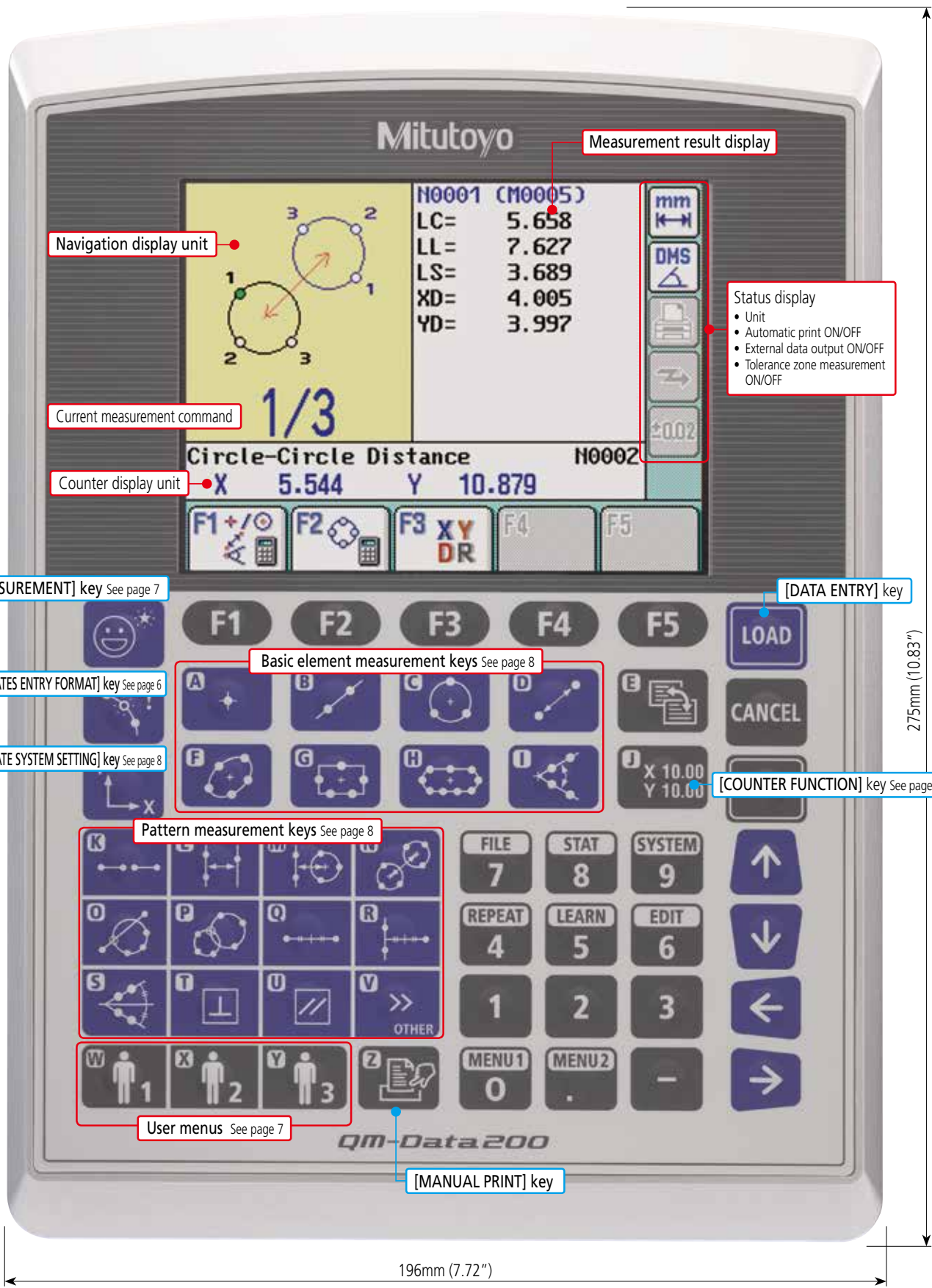

Navigation display unit

Measurement result display

Current measurement command

Counter display unit

- Status display
- Unit
 - Automatic print ON/OFF
 - External data output ON/OFF
 - Tolerance zone measurement ON/OFF

[AI MEASUREMENT] key See page 7

[DATA ENTRY] key

[COORDINATES ENTRY FORMAT] key See page 6

Basic element measurement keys See page 8

[COORDINATE SYSTEM SETTING] key See page 8

[COUNTER FUNCTION] key See page 7

Pattern measurement keys See page 8

User menus See page 7

[MANUAL PRINT] key

275mm (10.83")

196mm (7.72")

Functions for faster, easier and more efficient measurement

Navigation of measuring position

When using the Repeat function to execute a measurement procedure (part program) created with the teaching function, the Repeat function guides the operator to the next measuring point. This point is reached when the cross-hairs located at the center of the navigation display are placed over the other cross-hairs, which indicate the next measuring point. The operator also can be guided to the next measuring point by moving the stage to a position where the digital counter reading approaches zero.

1. The next measuring point is indicated by the cross-hairs.
2. Move the measuring instrument stage to place one set of cross-hairs over the other (or to bring the counter reading to zero).
3. When the cross-hairs overlap, it is close to the next measuring point.
4. Press [LOAD] to enter data, using the cross-hairs of the measuring instrument

Teaching function

When measuring more than one workpiece of the same form, the series of key operations performed in the measurement of the first workpiece can be stored as a part program.

The coordinate entry format function

In a measurement using the coordinate entry format, the coordinates calculated from the measurement data (coordinates of the center of a circle, etc.) are applied to data entry as one measuring point. For example, measurement of the pitch of a rectangular hole can be executed simply by selecting the [PITCH MEASUREMENT] key and [RECTANGULAR HOLE CENTER] in the coordinate entry format.

Measurement of a pitch circle whose circumference intersects with the three hole centers.

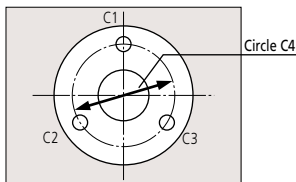

Types of coordinate entry formats

	Directly entered points Use the point that has been entered as a measuring point		Center of ellipse Use the center of the ellipse as a measuring point.		Midpoint between the two Use the midpoint between the two points as a measuring point.
	Center of rectangular hole Use the center of the rectangular hole as a measuring point.		Center of circle (three points) Use the center of the circle whose three points have been entered as a measuring point.		Center of slotted hole Use the center of the slotted hole as a measuring point.
	Center of circle (four points) Use the center of the circle whose four points have been entered as a measuring point.		Intersection of two straight lines Use the intersection of the two straight lines as a measuring point.		



1. Press [CIRCLE MEASUREMENT] to measure circle C4.



2. Press [COORDINATE ENTRY FORMAT].

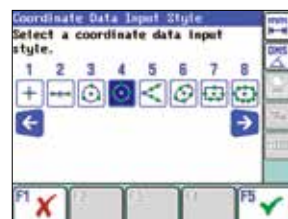

3. Measure circle C1 (entry of four points). Likewise, measure circles C2 and C3.



4. Select the center of each circle (entry of four points).

Coordinate entry format display unit

5. The diameter of the pitch circle (C4) can now be found.

Measurement status of pitch circle display unit

AI measurement function

With the AI measurement function (Automatic Element-Identification function), elements can be automatically identified based on data input from the measuring points. This function allows the continuous measurement of different elements, eliminating key entry for each element.

Continuous measurement of inside diameter (A) and angle (B)

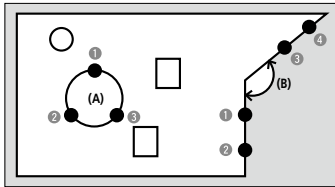

1. Select the [AI MEASUREMENT] key.

Elements that can be identified using the AI function

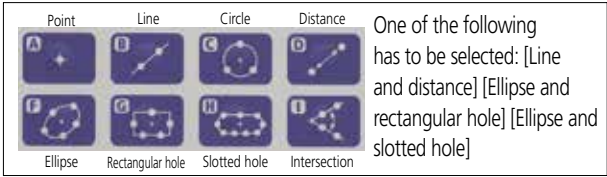

One of the following has to be selected: [Line and distance] [Ellipse and rectangular hole] [Ellipse and slotted hole]

(Note) The most recent measurement result is displayed.

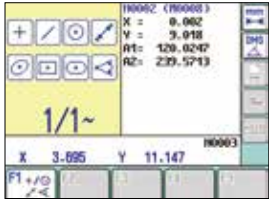

7. The measurement result for the angle is displayed.



6. End the measurement. (Press F5)



2. Input data from the three measuring points on inside diameter (A).



3. End the measurement. (Press F5)



5. Input data from the four measuring points on angle (B)

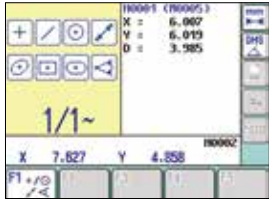

4. The measurement result for the inside diameter is displayed.

User menu

The user can customize the QM-Data200 to best suit their needs by registering frequently used measurement commands and necessary functions such as part programs, etc., to create an original menu (up to 3 menus).

[USER MENU] key



Example of user menu registration

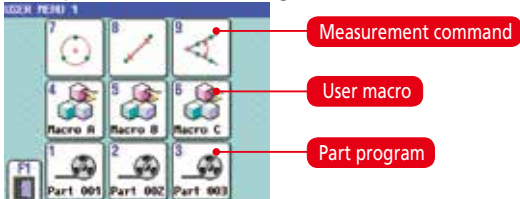

Note: A user macro is a measurement command created by the user, and is a combination of several measurement commands. Up to three user menus, from [USER1] to [USER3], can be registered. A maximum of nine icons can be registered for one menu.

Counter function

The QM-Data200 can be used as a counter when it is directly connected to a linear scale. Features zero-set and 1/2 display functions.

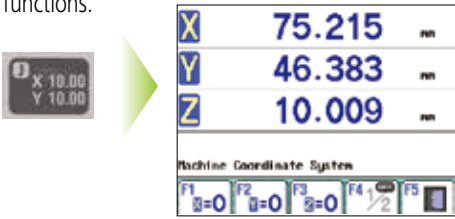











Tolerance zone measurement function

With this function, when nominal value and tolerance limits (upper and lower limits) are given, the difference between the measured value and the nominal value is compared with the tolerance zone.











A variety of measurement commands for all basic measurements











Creating the coordinate system

-  **Coordinate system pattern 1**
The line that passes the measuring point is the X axis, and the line that passes through another measuring point and intersects the X axis making a 90-degree angle is the Y axis.
-  **Coordinate system pattern 2**
The line that passes through the measuring point is the X axis, and its midpoint is the origin.
-  **Coordinate system pattern 3**
The line that passes through the measuring point is the X axis, and the intersection with another line is the origin.
-  **Coordinate system pattern 4**
The measuring point is the origin, and the line that passes through another measuring point is the X axis.
-  **Coordinate system handling**
Save, recall and reset the coordinate system.
-  **Origin setting**
Translate the coordinates horizontally until the measuring point is positioned as the origin. The displacement value can be entered directly.
-  **Determining axis by point**
Rotate the X axis coordinate in such a way that it passes through the measuring point. (The origin is not transferred.) The rotation angle can be entered directly.
-  **Determining axis by line**
Rotate the X axis coordinate in such a way that it becomes parallel to the measured line. (The origin is not transferred.)
-  **Compensation of offset axis**
Rotate the coordinate system until the measuring point comes to the specified position. (The origin is not transferred.)
-  **Compensation of plane**
Reduce the error caused by the inclination of workpiece setting (effectively used by measuring machines with a Z axis.).









Basic element measurement key

-  **Point**
Coordinates (Multi-point processing for a maximum of 100 points)
* In the multi-point processing, the mean value is used as the measured value.
-  **Line**
Angle and perpendicularity with the X axis. (Multi-point processing for a maximum of 100 points)
-  **Circle**
Center coordinates, diameter, roundness (Multi-point processing for a maximum of 100 points)
-  **Point-point distance**
Distance, Coordinates difference
-  **Ellipse**
Center coordinates, major-axis diameter, minor-axis diameter, angle with the X axis, Departure from the X axis (Multi-point processing for a maximum of 100 points)
-  **Rectangular hole**
Center coordinates, length, width
-  **Slotted hole**
Center coordinates, length, width, radius of slotted hole
-  **Intersection point and intersecting angle**
Intersection coordinates, intersecting angle, supplementary angle

Pattern measurement key

-  **Pitch**
Point-point distance, difference between coordinates, angle, cumulative distance, cumulative angle
-  **Line-point distance**
Perpendicular (shortest) distance
-  **Line-circle distance**
Center-center distance, longest distance, shortest distance
-  **Circle-circle distance**
Center-center distance, longest distance, shortest distance, difference between coordinates
-  **Line-circle intersection**
Coordinates of intersection
-  **Intersection of circles**
Coordinates of intersection
-  **Midpoint between points**
Coordinates of midpoint
-  **Midpoint between line and point**
Coordinates of midpoint
-  **Center line between line-circle**
Angle with the X axis
-  **Perpendicularity**
Perpendicularity
-  **Parallelism**
Parallelism

 **OTHER**
Key menu

-  **Circle-point distance**
Center-center distance, longest distance, shortest distance, difference between coordinates
-  **Midpoint between circles**
Coordinates of midpoint
-  **Projected point**
Coordinates of the point projected on a line
-  **Point-circle tangent point**
Coordinates of tangent point
-  **Circle-circle tangent line**
Angle with the X axis
-  **Corner**
Diameter, radius of corner circle, center coordinates
-  **Height**
Height (distance between steps in the Z axis direction)
-  **Plane-plane distance**
Distance between plane and plane (point)

Optional accessories

Thermal printer



- Used to print out measurement results.

* Contact your local Mitutoyo sales office for Order No. of this printer.

```

Printer ON/OFF
Contents to be Printed: All Results w
Command Names
Print
N0001
X = 1.002 Y = 2.002

Circle
N0002
X = 1.999 Y = 2.001
D = 2.000 PZ = 0.002

Circle-Point Distance
RLZ
N0003
LC = 0.997 LL = 1.997
LB = 0.003 LD = 0.997
VD = -0.001

Start Pitch Measurement
Pitch
N0004
LC = 1.006 LD = 1.006
VD = 0.005 AC = 18.2656
    
```

Printing method	Thermal serial dot
Printing digits	40 digits
Maximum print speed	52.5cps (normal characters)
Dimensions (XxDxH)	160mmx170mmx65.5mm (printer body)
Standard accessories	Printer cable, recording paper (1 roll), AC adapter (100V)

Optional Accessories

Order No. **908353** Recording paper for printer (5 rolls/set)

* Supports external printer (color or black & white) for ESP/C
Printer control code system: ESC/P, MS-DOS 24 pins



System configuration

1. Main unit with SPC output

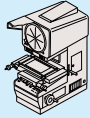

PJ-2505D/F, PJ-3000 series
PJ-H3000 series
PH-3515F (172-847)
TM-500 series

2. Main unit with RS-232C output

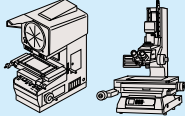

PJ-H30 Series (including Optoeye built-in type)
PJ-A3000 Series (built-in counter)
MF D series
MF-UD series

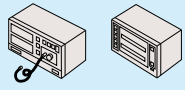

KC Counter (MF-H100)
KA Counter (PV600A)
OPTOEYE A2 Counter
 Each counter must be equipped with the RS-232C output interface.

3. Main unit with built-in Optoeye

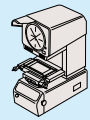

PJ-H3000F4 series
 (Optoeye built-in type)

4. Main unit without counter (equipped with Linear Scale built-in workstage)

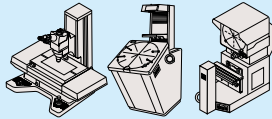

HyperMF/MF-U series
PV-5110
PH-3515F (No.172-858)
 Each shall be the model equipped with Linear Scale built-in workstage.

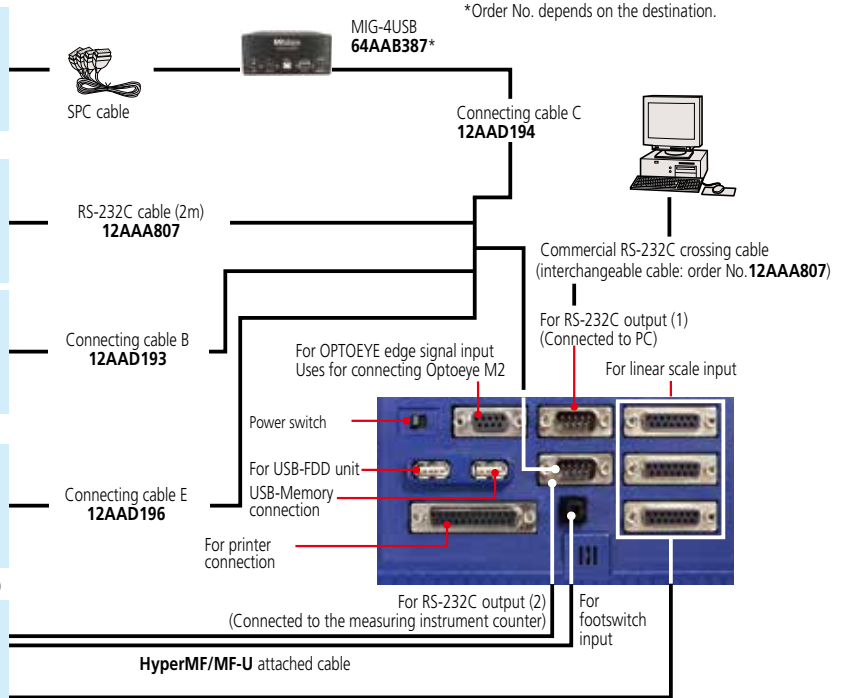

QM-Data200 Specifications

Code	QM-Data200		
	Stand-mount type 264-155A	Arm-mount type 264-156A	Stand-mount type 264-159A
Order No.			
Display languages (selectable)	Japanese/English/German/French/Italian/Spanish/Portuguese/Czech/Chinese/Korean/Turkish/Swedish/Polish/Dutch/Hungarian		
Measured value units	Length: mm Angle: degree/degree minute second (selectable)		
Resolution	0.1µm		0.01µm
Program functions	Part program creation, execution, editing		
Statistical processing	Number of data, maximum value, minimum value, mean value, standard deviation, range, histogram, statistics on a measuring function basis (by command)		
Display system	COLOR TFT LCD (with LED backlight)		
ABS (Absolute origin)	—		Supported (automatic travel)
LAF (Laser AF)	—		Supported
Edge Sensor Position Compensation	Supported (Projector)		
Input/Output	X,Y,Z: Maximum of three Linear Scales RS-232C 1: For connecting to external PC RS-232C 2: For connecting to counter of measuring instrument OPTOEYE: For inputting edge signal from OPTOEYE (OPTOEYE M2)	FS: For connecting to optional foot switch PRINTER: For connecting to optional printer USB-FD: For connecting to USB-FDD USB-MEMORY: For connecting to USB memory	Note2
Measurement result file output	RS-232C output (CSV format, MUX-10 format)		
Power	AC100 - 240V		
Maximum power consumption	17W (does not include optional accessories)		
External dimensions (WxDxH)	Approximately 260x242x310 (including the stand)	Approximately 318x153x275mm (when the arm is in the horizontal position)	Approximately 260x242x310mm (including the stand)
Mass	Approximately 2.9kg	Approximately 2.8kg	Approximately 2.9kg
Applicable models	PJ2500/PJ-3000 Series PJ-H3000 Series PJ-A3000 Series PH-3515F(No.172-847-5) MF D Series MF-UD Series	PJ-A3000 Series PJ-H30 PV-5110 PH-3515F (No.172-949)	HyperMF/MF-U
Standard accessories	AC adapter, power cable, Easy Operation guide		

Dimensions

Stand-mount type (Order No. 264-155A)

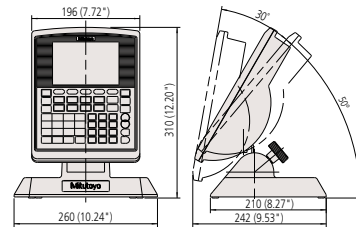

Arm-mount type (Order No. 264-156A)

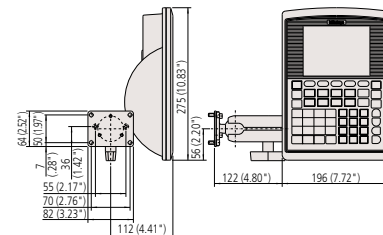

Note2: Mitutoyo does not guarantee the operation of all commercial USB memories except for the following:
 Mitutoyo recommends those USB memories made by SanDisk Corporation or IO DATA DEVICE, INC. and that meet the following requirements.

- Those that have no security function such as encryption and fingerprint authentication
- Those that are not compliant with USB3.0

Vision System Retrofit for Microscopes Vision Unit

FEATURES

- Efficient, manual vision measurement with a high-resolution camera (multi-megapixel class)
- The automatic edge-detection tools and various macro icons allow measurement in one easy step.
- Measurement results are output to MS-Excel®*. This lets the user generate an inspection table on the same computer.
- Allows the tolerance zone measurement of measurement results and various types of statistical processing for each item.
- The auto-brightness control function faithfully reproduces the type and degree of illumination used. (This function is limited to the MF/MF-U series.)
- Combined use with the focus pilot provides high accuracy in height measurements.
- A series of measuring operations can be performed using just one screen display.
- Digital zoom function (2X, 4X)
- Adoption of large LCD monitor

* MS-Excel® is a registered trademark of Microsoft Corporation.



More user-friendly manual measurement environments available

Wide-field measurement

Upsizing of the image sensor has made the field of view approximately 40% wider than conventional for both X and Y directions, thus allowing concurrent observation of the circumference of a measurement point.

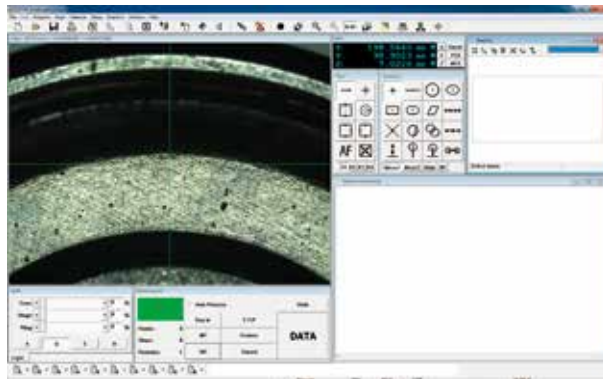

* An actual image using objective lens ML1X plus LED ring light

Digital zoom function

A normal 1X display image can be magnified to a 2X or 4X image by merely clicking the corresponding menu icon. The image can be measured to fine detail using the digital zoom display.



1x



2x



4x

Edge-detection support tools

One-click tools [Patent registered (application country: Japan)]

Each tool has the function of automatically discriminating operations from self tool setup to edge detection/calculation by merely single clicking the vicinity of a measurement point edge with the mouse. If measurement is performed in one tool window, these tools drastically reduce measurement time thanks to no need for stage travel.

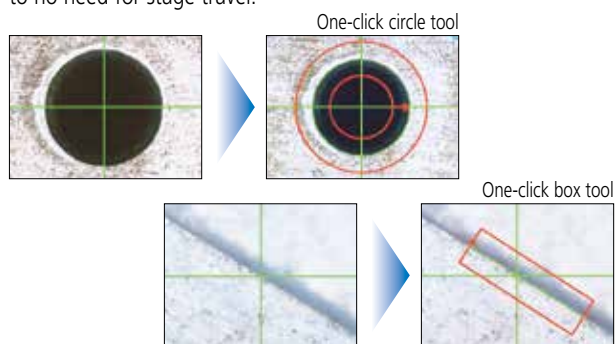

Smart tool [Patent registered (application country: Japan)]

This tool provides the function of automatically detecting the sharpest edge close to the center of the cross hairs. An edge is detected by just enclosing the location of a measurement point with a small circle. This method allows quicker edge detection compared with edge alignment using the cross hairs directly.

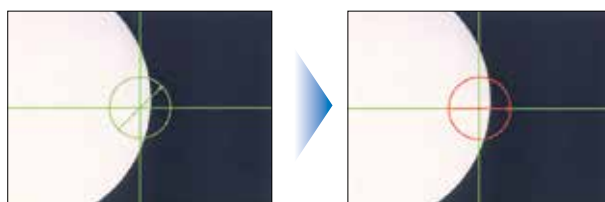

Template tools

Basic templates

The tool provides 3 types of templates corresponding to the reticles of a measuring microscope.



Cross hairs

Grid

Concentric circles

Manual pattern matching

This tool creates a pattern that matches a workpiece feature exactly so that tolerance zone judgment can be performed visually. The nominal profile line is defined, and then upper and lower limits are keyed in to construct the zone limit lines. With these lines displayed, a workpiece feature can be evaluated for conformance at a glance.

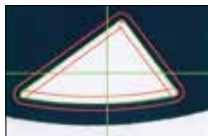

Extended templates

This tool allows free setting of values such as diameter, distance and angle through key entry on a profile projector. Four types of templates: cross hairs, circle, rectangle and angle are available.



Circle template



Angle template

CAD convert template

This tool allows generation of an original user pattern template from CAD data (line/circle/arc) imported through CAD data conversion processing.

*To import CAD data, optional software "CAD Import & Export" is required separately.

Coordinate system creation key

Coordinate system



Creation key

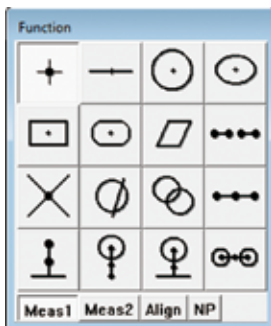

Coordinate value input formatting function (NP measurement)

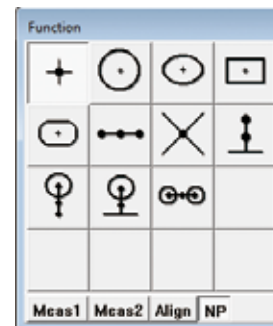

Functions for faster, more accurate measurement

Quick navigation [Patent pending (application country: Japan)]

The navigation function is combined with the teaching and repeat functions, by which a series of measurement procedures is memorized and reproduced. This function guides the operator to the next measuring point, following the measurement procedure that has been memorized. Move the stage until the green cross-hairs, seen at the center of the monitor screen, are superimposed on the red cross-hairs, which indicate the next measuring point, and only the green cross-hairs remain. In this state the next measuring point will be displayed on the screen. As the digital counter approaches zero, the screen will display the next measuring point. This eliminates the need to constantly look at the test piece in order to check the measuring point, thereby freeing the operator to concentrate on the screen displays.

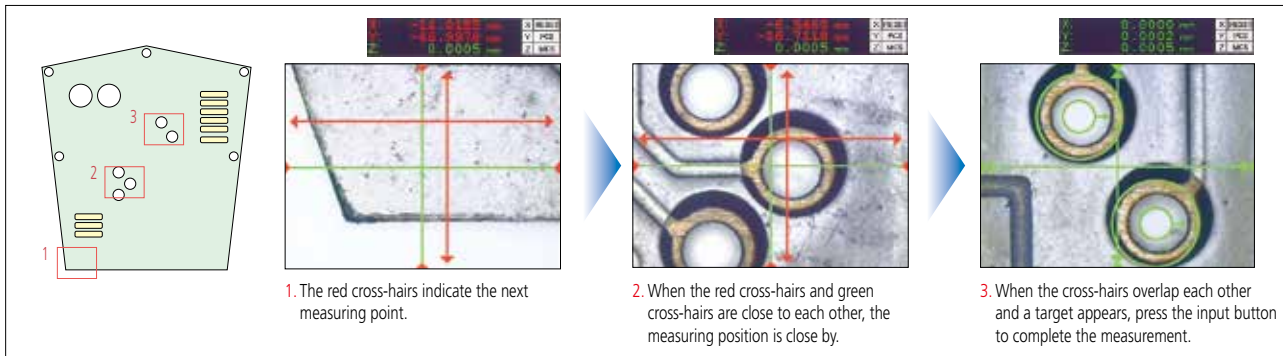

Measurement navigation

The measurement navigation function can be used to check the selected measurement command or current measurement status. It tells the operator what is being measured, the next measuring position, etc.



Graphics window

The real-time graphic display of measurement result and element provides a visual image of the measuring point. Also, the graphic display of measuring elements facilitates the selection of a measuring element, making for a quicker measurement process.



Abnormal point exclusion

This function automatically excludes any abnormal point having a burr or chip. The degree of abnormality to which the exclusion applies can be set as desired.



Counter window

Displays the center of the video window. It is easy to switch between the machine coordinate system (MCS) and the workpiece coordinate system (PCS). The vision unit can be used like a conventional measuring microscope, simply by setting the counter to zero.

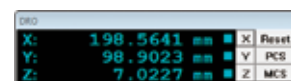

Smart Editor [Patent registered (application country: Japan)]

During a part program list display, the target position of XY stage travel, coordinate system creation, measuring item command, and edge detection tool are displayed independently as icons or on labels, to facilitate part program editing.

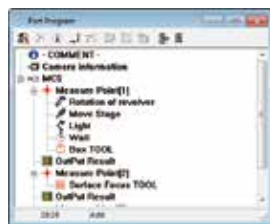

Icon Editor

Using the Icon Editor, the layout of icons such as the measurement key icon, tool icon, etc., can be freely arranged. The layout setting can be freely determined. For example, frequently used icons can be laid out on just one page.

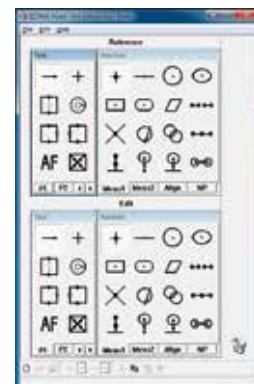

Auto-brightness control function (exclusive to MF/MF-U series)

The brightness of transmitted and reflected illumination used on a microscope can be controlled via the software on the PC. It is not necessary to adjust the illumination during a repeat measurement, since the level is reproduced according to the setting selected during the creation of the part program. Even in the measurement of a workpiece that requires variations in illumination, consistently accurate edge detection is ensured. This enhances the efficiency of repeated measurements.

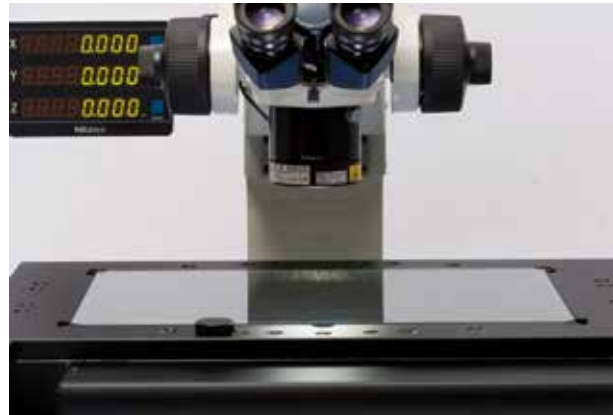
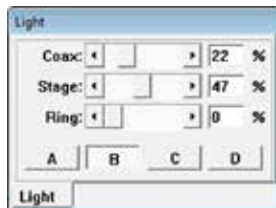

Contrast level [Patent pending (application country: Japan)]

The contrast around the center of the video window is indicated by a level meter. The peak that is indicated on the level meter is the focal point. This will improve the focal point reproducibility of a manual-type measuring microscope.

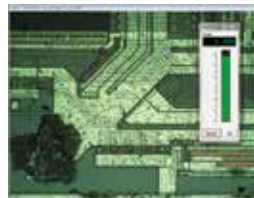
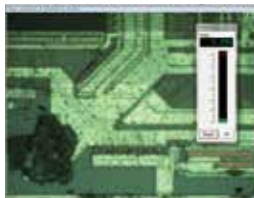

Focus before

After the focus

Video image scale display

The scale display, which is proportionate to the real field of view, on the video window lets the operator quickly grasp the approximate size of a test piece. The image can be saved along with the scale display.



Support from inspection table generation to measurement control

Saving image files

The color image on the video window can be saved as a BMP-format file for easy attachment to the image record or inspection table for the workpiece.

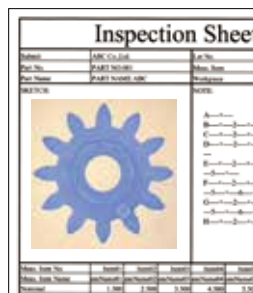

Image text display



Measurement results and comments can be added to the color image on the video window via the keyboard, and printed out or saved in a file.

Measurement result output [Patent pending (application country: Japan)]

The result of measurement using a part program, either before or after focusing, can be output in CSV format. This means the measurement result can be output to a commercial spreadsheet program such as MS-Excel®, so that an inspection table can be generated in the original format.



Security function

Access to the results can be limited, according to requirements, simply by setting a password.



Functions dedicated to measuring microscope MF/MF-U series power models

By installing this vision unit on a power-operated model in the measuring microscope MF/MF-U series, a wide choice of functions becomes available.

- Image-contrast detection is the basis of the image AF (auto focus) function. *1
- The installation of a power turret in the MF-U power model or MF-U LAF type allows the objective lens magnification to be changed on the QSPAK screen.
The objective lens in use is recognized automatically and displayed on the QS-PAK screen.*2

*1: AF cable (No.12AAN358) required separately.

*2: RS-232C cable (No.12AAA807) required separately.



System example: **MF-G2017D** plus Vision Unit 10D

Vision Unit 10D compatible models

Optical system	AF type	Observation method	Model	Power turret compatible
Finite system	Image AF	Bright field	MF-G2017D	—
			MF-G3017D	—
			MF-G4020D	—
Infinity system	Image AF	Bright field	MF-UG2017D	✓
			MF-UG3017D	✓
		MF-UG4020D	✓	
		Bright field/ Dark field	MF-UH2017D	✓
	MF-UH3017D		✓	
	Image AF-LAF	Bright field	MF-UE2017D	✓
			MF-UE3017D	✓
		Bright field/ Dark field	MF-UF2017D	✓
MF-UF3017D			✓	
		MF-UF4020D	✓	

FORMPAK-QV (Optional software)

FORMPAK-QV allows contour analysis and contour tolerancing against the nominal value, from the data acquired using QSPAK.

- Contour tolerancing function
- Fine contour analysis function
- Report generation function

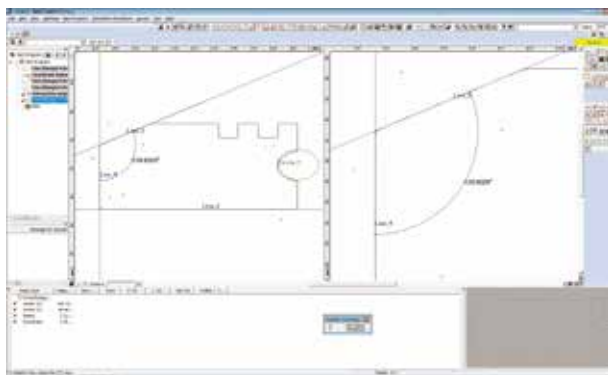

CAD import & export (Optional software)

Operability has been greatly improved, and the time required to create a part program has been greatly reduced, by importing the CAD data (DXF, IGES), as generated at the product-design stage, to QSPAK. The measurement result from QSPAK can be converted to CAD data.

FEATURES

- The nominal value of each measuring item is entered automatically.
- The graphics window can be used to calculate elements.
- Graphics data can be output in a specified CAD data format.

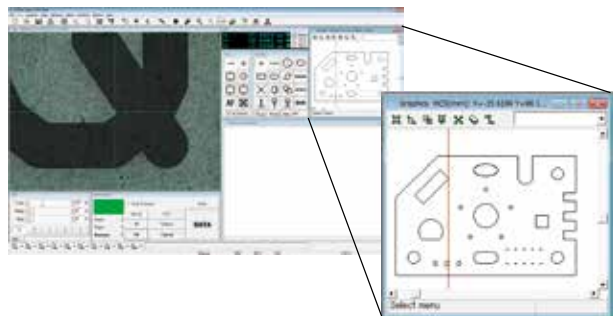

SYSTEM CONFIGURATION

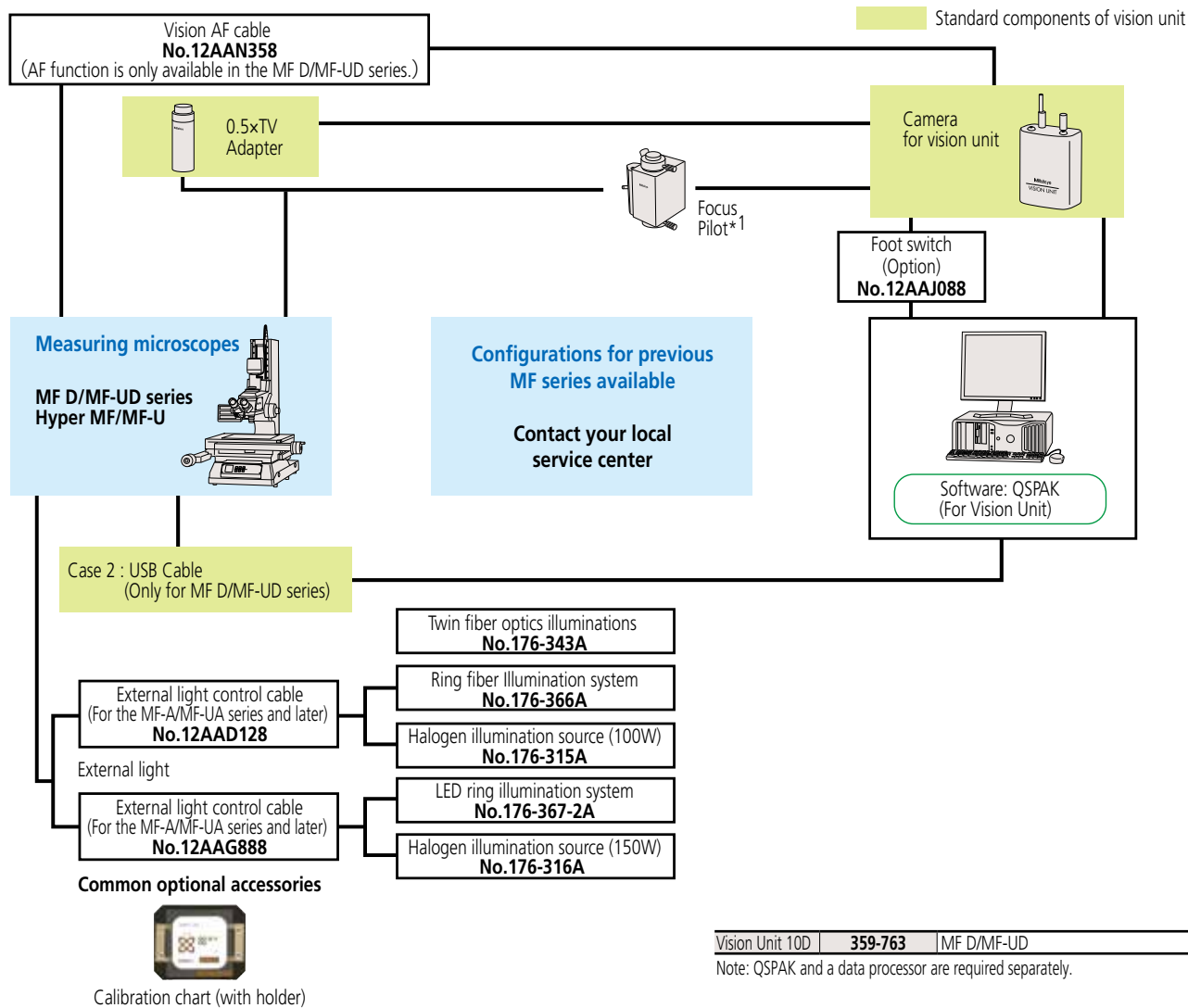

Specifications

Image detection camera	Image sensor	1/2-inch color CMOS with 3 mega pixels
	External dimensions / Mass (camera only)	56 (W) x 54 (D) x 78 (H) mm / 0.4 kg
	Optical system magnification	0.5X (0.5X TV adapter supplied standard)
PC	OS	Windows7
	Software	QSPAK Vision Unit
	Resolution	0.1 μ m (0.01 μ m if connecting to Hyper MF/MF-U)
	Axial length measuring accuracy*2 (Measuring condition: 20 °C)	Depends on the accuracy of the measuring microscope.
	Repeatability*3 (Measuring condition: 20 °C)	Depends on the accuracy of the measuring microscope. Reference: Repeatability on one screen (when Mitutoyo's standard sample is used) 3X objective lens is used: 3 σ = \pm 2.5 μ m or less, 10X objective lens is used: 3 σ = \pm 1.0 μ m or less

*1: Focus pilot is dependent on the Focus Detection Unit. The unit can detect a focus position at high accuracy and high repeatability.

*2: This measuring accuracy means a difference between an actual measurement value in vision measurement and a true value.

*3: Repeatability on one screen means the dispersion in measurement values when different positions within the same screen are measured repeatedly.

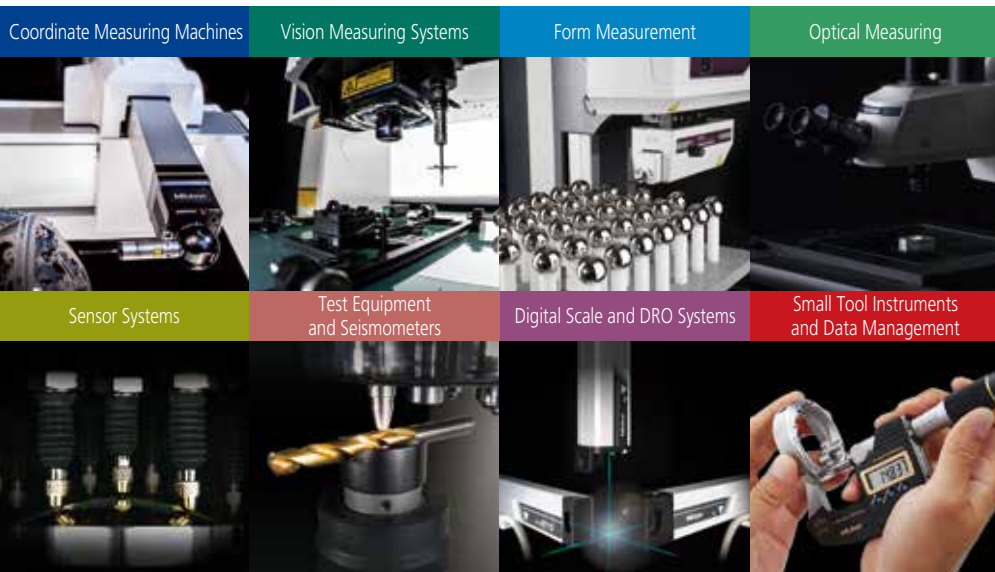

Whatever your challenges are, Mitutoyo supports you from start to finish.

Mitutoyo is not only a manufacturer of top-quality measuring products but one that also offers qualified support for the lifetime of the equipment, backed by comprehensive services that ensure your staff can make the very best use of the investment.

Apart from the basics of calibration and repair, Mitutoyo offers product and metrology training, as well as IT support for the sophisticated software used in modern measuring technology. We can also design, build, test and deliver measuring solutions and even, if deemed cost-effective, take your critical measurement challenges in-house on a sub-contract basis.



Find additional product literature and our product catalog

www.mitutoyo.com

Note: All information regarding our products, and in particular the illustrations, drawings, dimensional and performance data contained in this printed matter as well as other technical data are to be regarded as approximate average values. We therefore reserve the right to make changes to the corresponding designs. The stated standards, similar technical regulations, descriptions and illustrations of the products were valid at the time of printing. In addition, the latest applicable version of our General Trading Conditions will apply. Only quotations submitted by ourselves may be regarded as definitive. Specifications are subject to change without notice.

Mitutoyo products are subject to US Export Administration Regulations (EAR). Re-export or relocation of our products may require prior approval by an appropriate governing authority.

Trademarks and Registrations

Designations used by companies to distinguish their products are often claimed as trademarks. In all instances where Mitutoyo America Corporation is aware of a claim, the product names appear in initial capital or all capital letters. The appropriate companies should be contacted for more complete trademark and registration information.



Mitutoyo America Corporation

www.mitutoyo.com
 One Number to Serve You Better
 1-888-MITUTOYO (1-888-648-8869)

M³ Solution Centers:

- Aurora, Illinois (Headquarters)
- Boston, Massachusetts
- Huntersville, North Carolina
- Mason, Ohio
- Plymouth, Michigan
- City of Industry, California
- Birmingham, Alabama
- Renton, Washington
- Houston, Texas