



### Experience with Gaging Technology

Technical innovation and quality-oriented thinking are the core competencies of successful businesses. Both competencies are not possible without metrology. Measurement instruments verify research and development results and document product quality. Without continuous advancement of metrology there would be no technical progress.

Mahr Federal has been an innovator of precision hole gaging since the first air gaging was introduced in the 1940's. Mahr Federal has perfected the Single Master Air Gage system that out performs other systems with its accuracy and linearity. The quality is built into the tooling and display units.

Over this period of time Mahr Federal has designed 100,000's of air gages - from the most basic air plug to complex automated air gaging systems. All capable of measuring the most demanding manufactured pieces - critical for today's automotive, medical and aerospace requirements.

Recently Mahr Federal as further advanced its leadership with a new line of the most universal Dimensionair systems that allow for unmatched performance from adjustable magnification air gaging systems. Our breakthrough products bring easy to use and high performance to any air gaging system.

There are precision hole applications where mechanical fixed plugs may best fit the application. In the 1970's Mahr Federal again was an innovator in fixed plug gaging with the introduction of the Dimentron Plug in the 1970's. Again through the subsequent years thousands of successful Dimentron plug solutions have been employed in the manufacturing environment.

Engineering Solutions to these tough measuring application demands is done all within Mahr Federal. From the initial concept, through engineering design, precision manufacturing and finally assembling and test are all performed in house. We take full responsibility and accountability for the gages produced - right until they are delivered and performing on your shop floor.

To be a Metrology Supplier - one has to know and understand metrology. Mahr Federal has built one of the best Precision Measurement facilities in the country. Mahr Federal's calibration system is certified to ISO-9001:2000 by NQA, USA and accredited to ISO 17025 NVLAP Lab Code 200605-0.

We are committed to Metrology and to bringing the best metrology solutions to you.

## Dimensionair® Air Gages

### Why Mahr Federal Air Gaging?

Mahr Federal has been an innovator in air gaging since its introduction in the 1940's. With the Dimensionair system the accuracy is built into the readout and the tooling. With the new Universal Systems - precision magnification adjustments allow for the most linear two master systems available.

### Experience

Over this period of time Mahr Federal has designed 100,000's of air gages - from the most basic air plug to complex automated air gaging systems. All capable of measuring the most demanding manufactured pieces - critical for today's automotive, medical and aerospace requirements.

### Innovation

Mahr Federal offers a wide range of display and tooling options. Offering basic and proven performance along with some of the most progressive portable gaging systems bring precision to the shop floor. New materials for air tooling such as Stainless Steel, Chrome products, 10V, D2 and Tungsten Carbide are some of the options for manufacturing tooling that meets the requirements of your specific application.

### Delivery Performance

Ordering Tooling and not having it when you need it just does not work. Mahr Federal has put in place manufacturing principles that can get the tools you want when you need them. We deliver on time - to customer's expectations and demonstrate it time after time.

### Value and Service

Mahr Federal offers one of the largest trained sales teams to offer expertise to solve your measurement problems. A team of Direct Field Sales personnel, Providence based Application Engineers and Factory Trained Distribution are all available to support you both before and after the sale. Combine this with new processes that actually allow for more cost effective tooling helps to provide the best value for your measurements solution.

### Table of Contents

Description	Page
The need for Air gaging	2
What is air gaging and how does it work?	3
Advantages of Mahr Federals Long gaging range Single Master	4
Dimensionair Air Gaging Applications	5
Air Gaging - plugs	9
Measuring Deep holes	14
Air Plug Accessories	15
Plug options / Applications	16
Air Rings	17
Air probes / Jet Probes	19
Accessories	20
Universal Dimensionair	25
Dimensionair	26
µDimensionair	27
Column format air gaging	29
832 Dimensionair Air Gaging	30
Millimar C 1210 and C 1245 Amplifiers	32
Ordering Air plugs	34
Ordering Air Rings	35
The need for fixed plug gaging - Dimentron	37
The Dimentron Plug - built for performance	38
Dimentron Plug Applications	39
550 Portable Gage System	44
Dimentron Plug accessories	45
Dimentron Plug Application configurations	47
1840 Column	48
C1208 Digital Amplifier	49
C1245 Digital/Analog Amplifier	50
Ordering Dimentron plugs	51
Indicator Plug Gage 844D	52
Plug Gages	53
Handles and accessories	54
Self centering plug gages 844 K	57
Plugs and Probes	58
Stands	61
Master Rings/discs/plugs	62
Ordering plugs and rings	65
Calibration service	66

## Dimensionair® Air Gages

### The Need for Air gaging

Air Gaging is the inspection tool that allows you to measure many jobs faster, more conveniently, and more accurately than by other gaging methods. In the measurement of all hole conditions, air gaging is unsurpassed for speed and accuracy, while in checking any dimensional characteristic, air offers sufficient magnification and reliability to measure tolerances well beyond the scope of mechanical gages.

#### Easy to Use

Production workers do not require special training to use air gages. To check a hole, for instance, it is not necessary to develop skill in rocking the gage to find the true diameter, merely insert the air plug in the hole and read the meter. It is as simple as that.

#### Economical

Once the basic gage is purchased, additional tooling for a wide variety of jobs can be used with it. It is not necessary to buy a complete gage for each new dimension that requires checking. Because of its adaptability, air gaging often becomes the primary measuring system in a complete quality control program.

#### Versatile

Air gages effectively measure all common types of dimensions and are particularly suited to checking dimensional relationships. Some of these are taper, parallelism, squareness, straightness, and center distance. Match gaging, which permits the selection of mating parts for a specific amount of clearance or interference, is easily accomplished with just one reading on one dial.

The non-contact characteristic of air gaging makes them particularly useful for checking soft, highly polished, thin-walled or otherwise delicate material.

Small gage heads and remote reading meters give air gages a distinct advantage in measuring multiple dimensions. Fixtures are smaller and remote meters permit placing contacts in positions that are inaccessible for other types of gages. Air gaging is often combined with electronic signaling to provide instant indication of part size.

Air gages are readily adaptable to measuring parts in the machine. Their small gage heads make most dimensions accessible with new displays that can bring the measurement results right to the point of manufacture. Thus speeding the process and making it easier for the operator to make his critical measurements. A unique advantage is that the stream of air tends to clean the measuring area from coolant or oil, providing accurate measurement without first cleaning the part.



## What is Air Gaging and why does it work

Air gaging is a measuring system that uses airflow and/or air pressure to determine the size of measured part. With the laws of physics to make the measurement the system relies on the fact that flow and pressure are directly proportionate to clearance and react inversely to each other.

The relationship between air pressure and distance of a restriction (workpiece) to the air escape (jets) can be plotted on a graph - (line a). As the distance between jets and work surface increases, the pressure decreases and the ratio becomes linear as represented by the straight section "B".

This straight portion of the curve can be accurately calibrated, and represents the scale of the Dimensionair. Compare its length with "C" on the other curve, which is the usable portion of other air gage scales. This longer linear scale gives the Dimensionair its longer usable measuring range. Note also that the Dimensionair scale is displaced further to the right, providing more initial clearance between the air plug and workpiece surface for easier gaging.

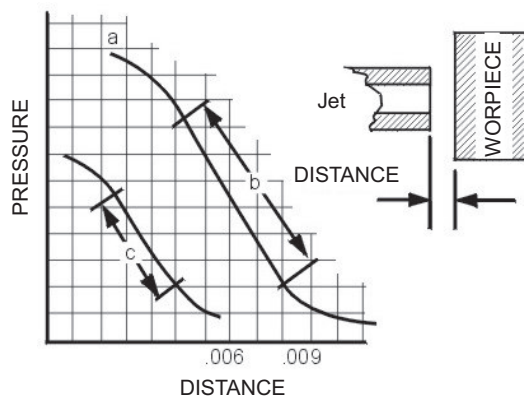

### Dimensionair Air Gages

Mahr Federal's Dimensionair Air Gages are unique among dimensional air gages. Basically a differential air pressure type, they are the only instruments that give you the advantages of fixed magnification and a balanced air system. A linear, precisely calibrated scale provides graduations of definite, known values. Greater tooling clearance for increased wear life, setting to "Zero" with only a single master with no other masters required, and immunity to normal air pressure fluctuations are additional advantages of the exclusive Dimensionair system. With the Mahr Federal differential system the accuracy is built into the tooling and the display.

### How the Balanced Air System Works

With the balanced air system, air from the supply line first passes through a regulator, then is divided into two channels. Air in one leg (the reference channel) escapes into the atmosphere through the adjustable zero restrictor, while air in the opposite leg (the measuring channel) escapes through the gage head jets. The two channels are bridged by an extremely precise indicating meter which responds immediately to any differential in air pressure between the two channels.

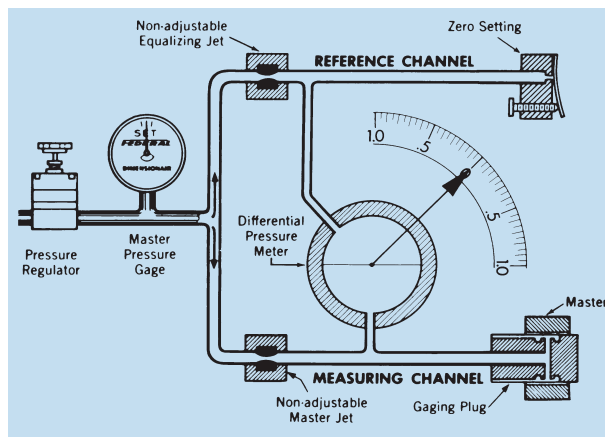

### Zero Setting Simple and Stable

With the Dimensionair's balanced system, setting zero is entirely independent of the measuring and magnifying functions of the gage. Magnification is fixed and cannot be affected by the setup process.

To set up the gage, a master is placed on the measuring head (producing a back pressure). The zeroing knob is then adjusted to equalize the air pressure in the two channels. When this condition exists, the dial reads zero. No further adjustment is necessary. Any deviation in the size of the workpiece from the master size will change the pressure in the measuring leg and produce a change in meter reading.

### Advances in Adjustable (2 Master) air systems -

Mahr Federal has taken the adjustable magnification back pressure system and adapted it for use with its precision differential meter and air/electronic transducers. The Universal Dimensionair's magnification is controlled matching the pressure to the precise balance between the tool and the reference channel. The second adjustable restriction releases excess air to the atmosphere to adjust the zero position. This system is capable of the broad magnification adjustment of any air gage system. It accommodates almost any size nozzles, as large as 0.050 in. or as small as 0.020 in.

Two setting masters - minimum and maximum - are used to calibrate the system, defining and displaying both ends of the particular tolerance range. With modern electronic systems this process can be automated so that the gage leads the operator through the mastering routine. The zeroing and magnification adjustments are done automatically - without operator intervention.

Dimensionair® Air Gages

Additional advantages of Mahr Federal long gaging range – single master

The long measuring range of the Dimensionair system permits a smaller bodied air plug, which provides greater plug clearance. Even with greater clearance, there is no centralizing error. The total clearance between plug body and setting ring is detailed in the table below. Direct Benefits of Greater Clearance:

Tolerance Clearance from Nominal Size

Plug I.D.	Nominal Size above mm/in	To & include mm/in	Clearance from Nominal Size mm/in
DP100, DP60	.63/ .248"	76.4/ 3.004"	0.081/ .0032"
DP50	3/ .123"	3.5/ .140"	0.015/ .0006"
	3.5/ .140"	4.7/ .185"	0.027/ .0011"
	4.7/ .185"	6.3/ .248"	0.030/ .0012"
	6.3/ .248"	76.5/ 3.010"	0.045/ .0018"
	76.5/ 3.004"	127/ 5"	0.051/ .0028"
Above 127/ 5"		0.071/ .0032"	
DP20	3/ .123"	3.5/ .140"	0.009/ .00035"
	3.5/ .140"	4.7/ .185"	0.013/ .0005"
	4.7/ .185"	6.3/ .248"	0.015/ .0006"
	6.3/ .248"	76.5/ 3.010"	0.023/ .0009"
	76.5/ 3.004"	127/ 5"	0.028/ .0028"
Above 127/ 5"		0.033/ .0032"	
DP10	All sizes to 1.750		0.009/ .00035"
DP5	All sizes to 1"		0.004/ .000175"

**More versatile gaging** - Dimensionair plugs easily enter irregular holes to check conditions such as taper, out-of-round, barrel shape, etc. that are inaccessible to plugs with less clearance.

**Increased gaging speed** - Quicker entrance into the hole and no jet positioning problem makes gaging faster with Dimensionair plugs than with plugs which require less clearance.

**Less plug wear** - Greater clearance eliminates much of the wear caused by the plug body rubbing on the edge and walls of the hole. If, after long hard use, a Dimensionair plug should wear, there is no effect on magnification, as frequently occurs with air gages that do not use fixed magnification.

**Large, deep-set Air Jets** - Longer range permits the measuring jets to be set deep into the plug body, providing good protection. Dimensionair jets are larger and less likely to become clogged.

Measuring range/magnification

Type	Measuring range	Magnification
DP 50	76µm/ .003"	2500:1
DP 20	38µm / .0015"	5000:1
DP 10	15µm/ .0006"	10,000:1

For applications greater than 1000 feet, special calibration is required.

The Dimensionair System is known as the One Master Air Gage because only one zero master is required for each size to be measured. This economical feature is the result of fixed magnification - the accuracy is built in! Because its magnification cannot be adjusted or changed accidentally, or drift because of air-line surges, the Dimensionair has a linear, calibrated scale with meaningful graduations.

It's easy to set zero

Step one - place the Master on air tooling.

Step two - Adjust zero setting screw until meter hand is on zero. or - press Auto Zero on Electronic Systems

That's all. Set-up is completed in just a few seconds.

**Stability - Once Set, Stays Set**

An outstanding feature of the Dimensionair is its stability. Once set, zero does not drift. Because the air pressure in the balanced system is split between two channels, any normal changes in pressure from the regulator or larger surges in the factory air system affect each channel equally and thus cancel out. Therefore, the gage setting is not affected. The only change in measuring pressure is through the variation of workpiece size.

**Dependability**

Fixed magnification, which is never disturbed by searching for zero or by changes in source pressure, and the stability of its zero setting are why the Dimensionair is so dependable. Tolerance limits never shift during the working day, remaining the same for the last piece as for the first.

Dimensionair is the gaging of choice in automatic machine control. where a lack of reliability in the gaging process can upset an entire production schedule.

**Advances for Two Master Systems**

Mahr Federal has taken the adjustable magnification system to new limits. For those applications where min-max mastering systems have been incorporated the flexibility of the Universal Dimensionair and two mastering electronic amplifiers provide new read out capabilities. The Universal Dimensionair can act as a single master set-up with all its advantages - or can be adapted to virtually any existing dual master air tooling. Therefore, it is not necessary to switch air gaging systems - just choose the adaptability of a Mahr Federal display and put your system to use.

## Dimensionair® Air Gages

## Dimensionair® Air Gaging Applications

Though most frequently used for diameter measurement, many other types of dimensional conditions can be checked more conveniently, more accurately, and more economically with the Dimensionair than with other types of gages. Though it would be impossible to show every type of measurement successfully accomplished by air, here are a few representative examples:

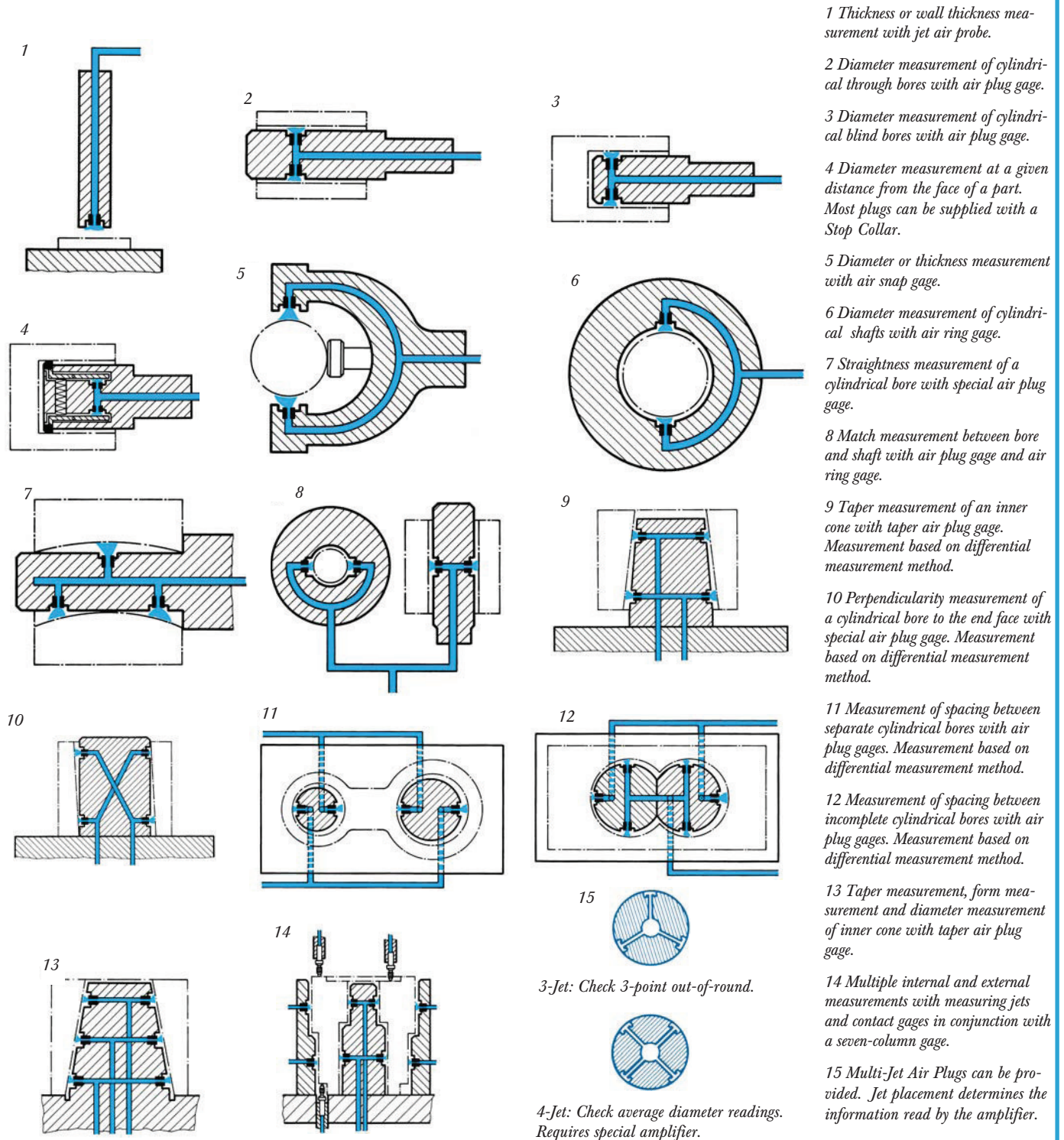

## Dimensionair® Air Gages

### Dimensionair® Air Gaging Applications

Though most frequently used for diameter measurement, many other types of dimensional conditions can be checked more conveniently, more accurately, and more economically with the Dimensionair than with other types of gages. There are thousands of gaging applications successfully accomplished by air, here are a few representative examples of the more frequently encountered applications.

The balanced system of the Dimensionair offers unique advantages in gaging certain dimensional conditions such as concentricity, squareness, or straightness. Not only can one Dimensionair do the job for which two gages are usually required but, for these applications, it requires no master.

### Straightness

Dimensionair gages can be used to check straightness of either inside or outside surfaces as well as diameter. For internal measurement, an air plug is furnished with a pair of opposed jets to check diameter and a set of four jets arranged as shown in the diagram for inspecting straightness. The diameter air jets and the straightness jets are each connected to separate Dimensionair meters. As the plug is passed through the part, both diameter and any lack of straightness are clearly displayed on their respective

meters. An air ring can be similarly equipped to check both diameter and straightness of external surfaces.

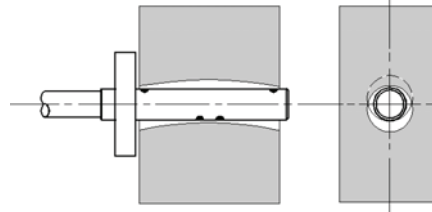

### Clearance and Interface (Match Gaging)

Balanced calibrated system of Dimensionair permits reading clearance or interference of mating parts, as well as the actual diameter of each part, on one dial without any adjustment or resetting.

Air plug and ring are connected through "T" fitting to measuring side of special air meter. One part (serving as reference) is placed in gaging position and various mating pieces checked in turn until proper clearance reading (left of zero) is obtained. Readings to right of dial indicate interference. Diameter of either part can be sized directly by comparing against master of mating part.



### Center Distance



Center distance between bores is checked without influence from piece to piece variation in size on a differential Dimensionair. Two dual jet air plugs are used as a pair, with the two "near" jets channeled together as are the two "far" jets. These combinations are then introduced to opposite sides of a differential meter. Spacing of air plugs in the fixture is set to show the ideal condition, so the meter hand reads zero with a master or nominal workpiece in place. With this arrangement, any change in diameter will affect each pair of jets equally so that center distance checks will be independent of hole diameter. Same type of arrangement using air rings serves center distance of O.D.'s. In each case, only one Dimensionair is required at considerable cost saving over competitive makes.



## Dimensionair® Air Gages

### Squareness

#### Bore-to-face: Method A

An air plug having offset jets is mounted on platen. Part is rotated 180 degrees. Comparison of total indicator readings shows relative squareness as compared to that of master or a nominal condition workpiece.

A 2-jet air plug mounted on a precision platen is connected to a regular Dimensionair meter. Inset shows location of offset air jets on opposite sides of air plug.

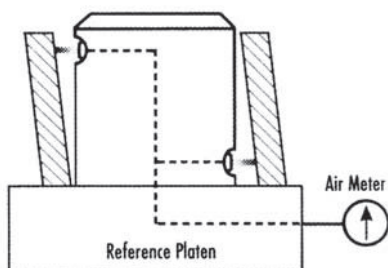

#### Bore-to-face: Method B

Top and bottom jets on each side of air plug are channeled to opposite sides of a special air meter to provide differential type measurement. Lack of squareness is indicated by movement of meter hand as part is rotated on reference platen. This method is used primarily when squareness reading should not be influenced by any taper condition.

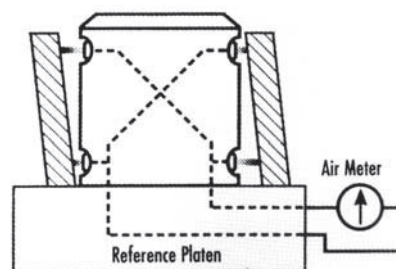

### Flatness



When small parts are involved either contact or non contact measurement can be made using an airprobe or jet probe set in a small surface plate. Proper probe depth is accomplished by an adjusting bracket. The inspection of the part is made by simply moving it over the probe and reading flatness variations directly on the Dimensionair readout.

Flatness gage specifications: Surface plate of black Granite, typical 12" x 12" x 4" (inspectin grade A). Three point support provides accuracy to 50μ" Other plate sizes and accuracies are available.

For large parts that are too large to move over a surface plate the probe can be mounted into a serrated plateed that has been lapped flat. This assembly is moved over the part and read out on the air gage readout.

### Automatic Gaging Applications

Special tooling can be designed and manufactured for use in automatic gaging systems. Plugs with multiple jets and circuits can be configured for virtually any size and geometric condition.

Diameter, taper, straightness, concentricity and center location can be checked quickly and accuracies with an engineered air plug. Because air jets can be machined into locations there electronic probes would not fit they provide unmatched gaging capabilities. When the parts are rotated, dynamic checks such as out of roundness and max or min diameters can be found.

Also special wear strips and floating tooling adaptors can be designed into the automatic gaging station to provide long life of the plug for thousands of dimensional checks.



Dimensionair® Air Gages

Taper Gages

The use of tapers has never been more important than it is today. In the manufacture of tool holders and spindles, the control of taper and size determines how well the machine can perform during its cutting cycle. In orthopedic parts, the matching of tapers is critical to how well the knee or shoulder replacement will perform. Air gaging is ideal for these applications. Multiple circuit air jets can be placed in very small tapers where another method can be used to match air gaging speed and performance.

Two conditions most important in controlling taper are taper size and angle. Size is controlled by tolerance, and is, therefore, identical to a cylindrical I.D. or O.D. Taper angle, on the other hand, can be controlled by at least three different methods:

1. Included angle or angle per side.
2. Taper per inch or per foot.
3. Controlling two diameters at specified datum locations.

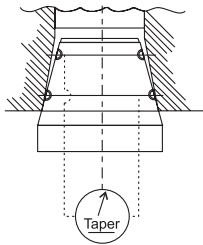

Simple "Jam Fit" design provides measurement of taper angle

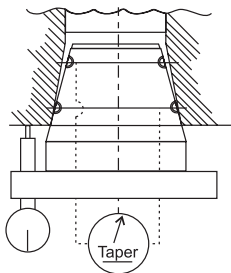

Addition of indicator provides indication of taper diameter

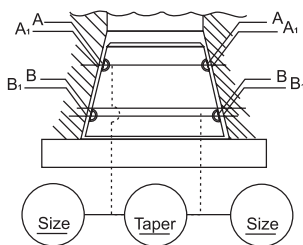

Shoulder style allows for independent circuits allow for taper and diameter measurement. Addition third circuit can help determine straightness of taper side.

Regardless of the method used, the effect on tapered air gaging is the same, since it produces a differential change between two diameters at a fixed distance apart.

The two styles of tooling are *Shoulder* and *jam* Fit. The function of the tapered part to be measured determines the style.

*Jam* Fit tooling measures taper angle as a differential change between two diameters, ignoring change in taper size. For example, if the tapered size increased by .254mm/.010", but the angle had not changed, the differential meter would indicate no change in reading. These parts have no shoulder or a controlling face, and become joined at the point of taper. If a tapered hole is not controlled for size, for example, the mating taper is allowed to drop deeper or ride higher in the hole as the size changes. A typical example is (NMTB) machine tool tapered spindles and collets.

*Shoulder* style tooling is capable of checking both taper size and angle simultaneously. Typically, one or both of the parts to be measured will have a shoulder or a face from which the size of the taper is dimensioned. The function of these parts demand that both the size and angle be controlled. Manufacturers of some type of orthopedic joints require that size and angle, and often times runout of the tapered diameter, be measured.

Mahr Federal can provide taper tooling for a wide variety of standard machine tool tapers including ISO7388 and 297 along with tools for checking HSK holders. Contact your Mahr Federal representative for ordering details.

When specifying a taper requirement, always consider:

What is to be measured?

- Taper angle,
- Diameters at certain locations,
- Taper and diameter.

Length of taper and possible location for sensing points.

Should the gage be portable or bench mounted?

What does the operator need for readout?



The Millimar S 1841 Vmeasuring instrument with LED display is most suitable for use on the shop floor.

## Dimensionair® Air Gages – Air Plugs

### Calibrated I.D. tooling for the Dimensionair® Air Gaging Systems

#### Features

- Tooling is interchangeable without adjusting system magnification.
- Federal Air Plugs have large clearance (see table below), allowing easy entrance into the hole being measured and greater measuring range.
- Long life - wide clearance and hard chrome (optional) body extends useful life of the Air Plug.
- Deep, recessed jets - Air jets are recessed into the plug body which protects them from damage.
- Large jet size eliminates clogging from dirt and oils.

#### Plug Identification



Air Plugs are marked with an identification number which identifies its size, number of jets, plug style, and the Dimensionair® Model the plug should be used with.

For example: **DP50-T2-1.000** is the identification number of an Air Plug for a **2095184** or a standard magnification 832 Dimensionair (DP50), through-hole style with two jets (-T2), and 25mm/1.000in nominal size (-1.000).

The number (50) which identifies the Dimensionair intended is marked on the plug and also appears on the dial of the Dimensionair to help in matching the tooling to its corresponding Dimensionair Model.

#### Total Clearance from Nominal Size

Plug Identification	Nominal Size from mm/in	To & include mm/in	Clearance from Nominal Size mm/in
DP100*, DP60	3/.123"	3.5/.140"	0.030/.0012"
	3.5/.140"	4.7/.185"	0.045/.0018"
	4.7/.185"	6.3/.248"	0.061/.0024"
	6.3/.248"	76.3/3.004"	0.081/.0032"
	76.3/3.004"	127/5.000"	0.089/.0035"
	above 127/ 5.000"		0.107/.0042"
DP50	3/.123"	3.5/.140"	0.015/.0006"
	3.5/.140"	4.7/.185"	0.027/.0011"
	4.7/.185"	6.3/.248"	0.030/.0012"
	6.3/.248"	76.3/3.004"	0.045/.0018"
	76.3/3.004"	127/5.000"	0.071/.0032"
	Above 127/ 5.000"		0.081/.0032"
DP20	3/.123"	3.5/.140"	0.009/.00035"
	3.5/.140"	4.7/.185"	0.013/.0005"
	4.7/.185"	6.3/.248"	0.015/.0006"
	6.3/.248"	76.3/3.004"	0.023/.0009"
	76.3/3.004"	127/5.000"	0.071/.0028"
	Above 127/ 5.000"		0.081/.0032"
DP10	1.57/.062"	44.5/1.750"	0.009/.00035"
	44.5/1.750" up		0.014/.00055"
DP5	1.57/.062"	25.40/1.000"	0.004/.000175"
	25.40/1.000"	44.45/1.750"	0.005/.0002"
	44.45/1.750" up		0.007/.0003"

\* DP-100 not available below 9.525mm/.375in

#### Ordering Information

When ordering Air Plugs please specify:

1. Nominal I.D. Size and Tolerance.
2. Dimensionair Model to be used.
3. Air Plug style (Through Hole, Blind Hole, or Counterbore).
4. Air Plug finish (Chrome-plated or Hardened Steel).
5. Order Master Setting Ring at same time.



Through Hole  
and Blind Hole  
Air Plugs

Unless otherwise specified, Mahr Federal will furnish a 2-jet, Through Hole, High Chrome Air Plug for a 2500:1 Dimensionair.

**Through Hole Plugs (DP50 – DP20 & 60)**

3-4.7mm/ .123-.185"

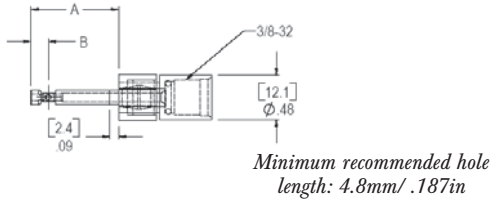

14.9-37.8mm/ .588-1.484"

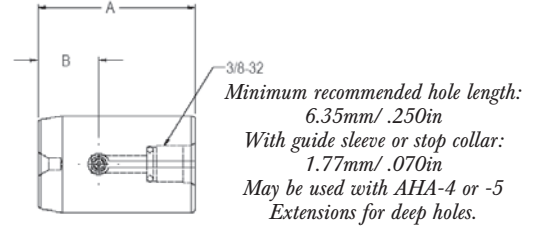

4.7-6.3mm/ .185-.248"

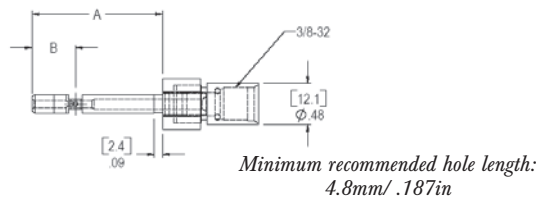

37.8-76.5mm/ 1.484-3.004"

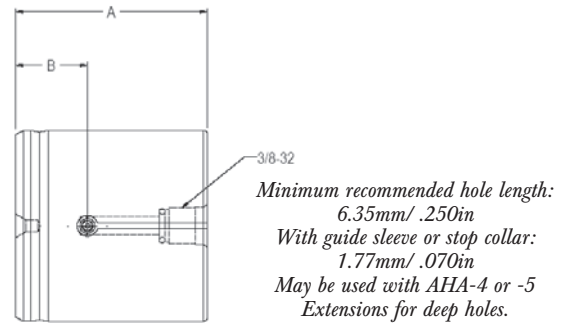

6.3-9.5mm/ .248-.3735"

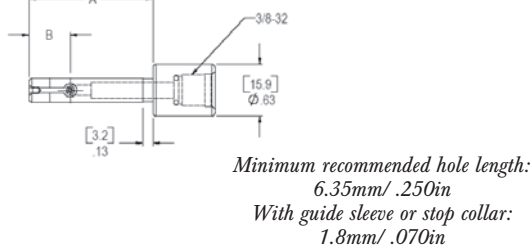

76.5-114.3mm/ 3.004-4/50"

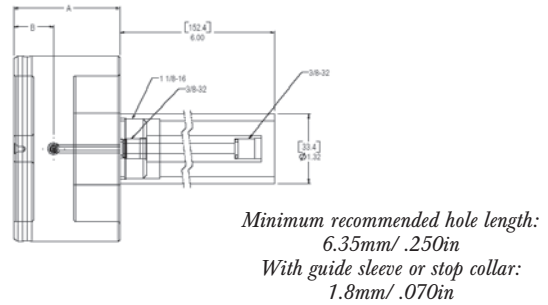

9.5-14.9mm/ .3735-.588"

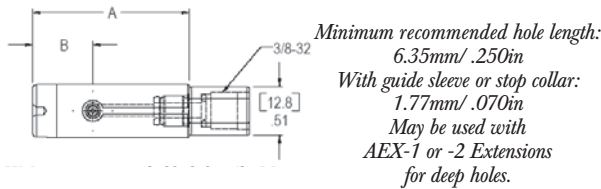

**Through Hole Plugs**

**Measured Size mm/inch**

Above	To & include	Measured Size		Minimum Hole Length*	Measuring Range		
		"A"	"B"		DP50	DP20	DP60
3/ .123"	3.5/ .140"	23.8/ .9375"	4.8/ .1875"	4.7/ .187"	0.025/ .001"	0.013/ .0005"	.051/ .002"
3.5/ .140"	4.7/ .185"	23.8/ .9375"	4.8/ .1875"	4.7/ .187"	0.038/ .0015"	0.020/ .00075"	.076/ .003"
4.7/ .185"	6.3/ .248"	38/ 1.5"	12.7/ .500"	4.7/ .187"	0.051/ .002"	0.025/ .001"	.102/ .004"
6.3/ .248"	9.5/ .3735"	38/ 1.5"	12.7/ .500"	6.4/ .250"	0.076/ .003"	0.038/ .0015"	.152/ .006"
9.5/ .3735"	14.9/ .588"	38/ 1.5"	12.7/ .500"	6.4/ .250"	0.076/ .003"	0.038/ .0015"	.152/ .006"
14.9/ .588"	37.8/ 1.484"	41.3/ 1.625"	15.9/ .625"	6.4/ .250"	0.076/ .003"	0.038/ .0015"	.152/ .006"
37.8/ 1.484"	76.5/ 3.004"	50/ 2"	19/ .750"	6.4/ .250"	0.076/ .003"	0.038/ .0015"	.152/ .006"
76.5/ 3.004"	114.3/ 4.5"	50/ 2" **	19/ .750"	6.4/ .250"	0.076/ .003"	0.038/ .0015"	.152/ .006"

\*If a guide sleeve or stop collar is used, minimum hole length can be as small as 1.8mm/.070in for holes larger than 6.3mm/.248in.

\*\*A handle 152mm/6in long and 33.3mm/1.31in diameter is supplied with plugs over 76.5mm/3.010in.

### Blind Hole/Counterbore Plug (DP50 – DP20 & 60)

3.9-4.7mm / .155-.185"

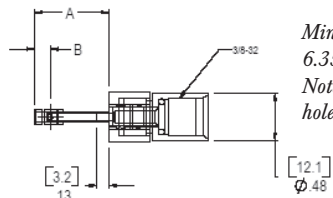

Minimum recommended hole length:  
6.35mm / .250in.  
Note: Masters must simulate workpiece for  
holes of this size.

11.8-14.9mm / .467-.588"

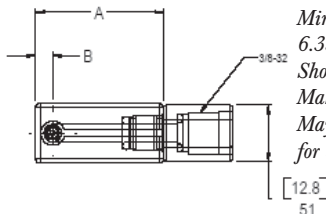

Minimum recommended hole length:  
6.35mm / .250in.  
Shorter bores can be checked. Consult  
Mahr Federal Customer Resource Center.  
May be used with Extensions AEX-1 or -2  
for deep holes.

4.7-6.3mm / .185-.248"

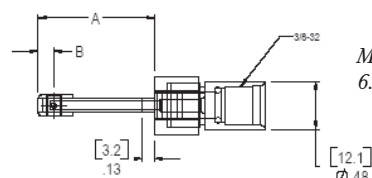

Minimum recommended hole length:  
6.35mm/.250in.

14.9-37.8mm / .588-1.484"

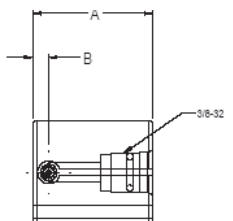

Minimum recommended hole length: 6.35mm/  
.250in. Shorter bores can be checked. Consult  
Mahr Federal Customer Resource Center. May be  
used with AHA-4 or -5 Extensions for deep holes.

6.3-9.47mm / .248-.373"

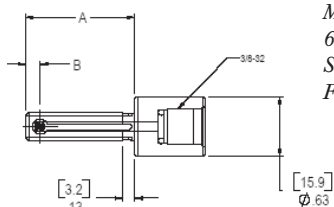

Minimum recommended hole length:  
6.35mm / .250in  
Shorter bores can be checked. Consult Mahr  
Federal Customer Resource Center.

37.8-76.5mm / 1.484-3.004"

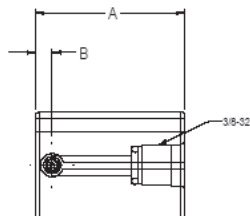

Minimum recommended hole length: 6.35mm/  
.250in. Shorter bores can be checked. Consult  
Mahr Federal Customer Resource Center. May  
be used with AHA-4 or -5 Extensions  
for deep holes.

9.47-11.8mm / .373-.467"

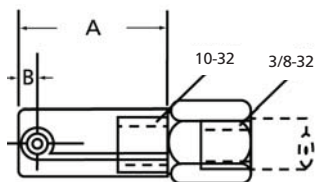

Minimum recommended hole length:  
6.35mm / .250in. Shorter bores can be  
checked. Consult Mahr Federal Customer  
Resource Center. May be used with  
Extension AHA-28 for deep holes.

76.5-108.2mm / 3.004-4.50"

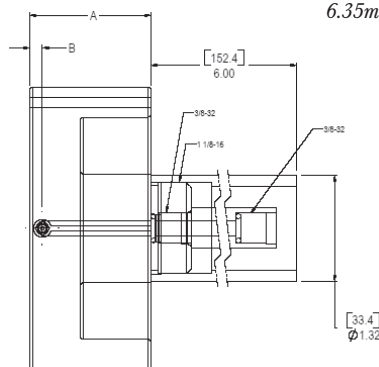

Minimum recommended hole length:  
6.35mm / .250in.

#### Super-blind Plugs

Blind Hole Air Plugs can be furnished to check shorter holes than listed above, and can be furnished to check closer to the bottom of a hole. Holes must be at least 1.9mm/.075in long, and the distance from the end of the plug to the center-line of the jets can be as short as 1.4mm/.055in for plugs below 6.4mm/.250in or 1.1mm/.045in for plugs above 6.4mm/.250in.

#### Blind Hole/Counterbore Plugs

Measured Size mm/inch		"A"		"B"		Minimum Hole Length*	Measuring Range		
Above	To & Include						DP50	DP20	DP60
3.9 / .155"	4.7 / .185"	19 / .750"	4 / .156"	6.4 / .250"	0.038 / .0015"	0.01905 / .00075"	.076 / .003"		
4.7 / .185"	6.3 / .248"	29.4 / 1.156"	4 / .156"	6.4 / .250"	0.051 / .002"	0.025 / .001"	.102 / .004"		
6.3 / .248"	11.8 / .467"	29.4 / 1.156"	4 / .156"	6.4 / .250"	0.076 / .003"	0.038 / .0015"	.152 / .006"		
11.8 / .467"	14.9 / .588"	29.4 / 1.156"	4 / .156"	6.4 / .250"	0.076 / .003"	0.038 / .0015"	.152 / .006"		
14.9 / .588"	37.8 / 1.484"	29.4 / 1.156"	4 / .156"	6.4 / .250"	0.076 / .003"	0.038 / .0015"	.152 / .006"		
37.8 / 1.484"	76.5 / 3.004"	35.7 / 1.406"	4 / .156"	6.4 / .250"	0.076 / .003"	0.038 / .0015"	.152 / .006"		
76.5 / 3.004"	114.3 / 4.5"	38 / 1.5" **	4 / .156"	6.4 / .250"	0.076 / .003"	0.038 / .0015"	.152 / .006"		

\*If a guide sleeve or stop collar is used, minimum hole length can be as small as 1.8mm/.070in for holes larger than 6.3mm/.248in.

\*\*A handle 152mm/6in long and 33.3mm/1.31in diameter is supplied with plugs over 76.5mm/3.010in.

**Through Hole Plug (DP10 – DP5)**

**1.6-6.4mm / .062-.250"**

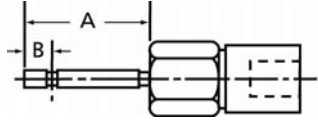

Minimum recommended hole length: 3.18mm / .125in.

**6.4-9.5mm / .250-.3735"**

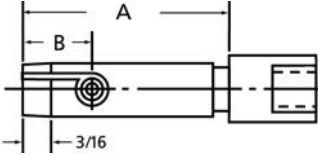

Minimum recommended hole length: 3.18mm / .125in.  
With guide sleeve or stop collar: 1.14mm / .045in.

**9.5-11.1mm / .3735-.437"**

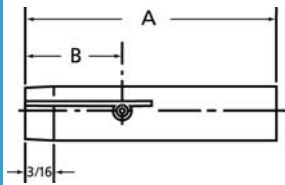

Minimum recommended hole length: 3.8mm / .125in. With guide sleeve or stop collar: 1.14mm / .045in. May be used with AHA-23 or -24 Extensions for deep holes.

**11.1-44.5mm / .437-1.750"**

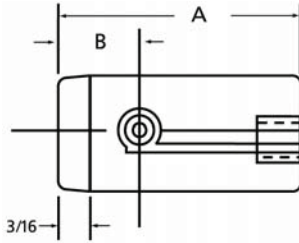

Minimum recommended hole length: 3.18mm / .125in with proper support min. is 1.14mm / .045in. May be used with AHA-23 or -24 Extensions for deep holes.

**44.5mm & Up / 1.750" & Up**

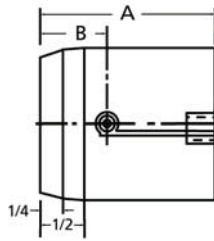

Minimum recommended hole length: 3.18mm / .125in. With guide sleeve or stop collar: 1.14mm / .045in. May be used with AHA-23 or -24 Extensions for deep holes.

**Through Hole Plugs**

Measured Size mm/inch		Minimum Hole Length*		Measuring Range		
Above	To & Including	"A"	"B"	DP10	DP5	
1.6/.062"	6.4/.250"	23.8/.9375"	4.8/.1875"	3.2/.125"	0.015/.0006"	0.008/.0003"
6.4/.250"	9.5/.3735"	38/1.5"	12.7/.500"	3.2/.125"	0.015/.0006"	0.008/.0003"
9.5/.3735"	11.1/.437"	41.3/1.625"	15.9/.625"	3.2/.125"	0.015/.0006"	0.008/.0003"
11.1/.437"	44.5/1.750"	41.3/1.625"	15.9/.625"	3.2/.125"	0.015/.0006"	0.008/.0003"
44.5/1.75"	76.5/3.010"	50/2"	19/.750"	3.2/.125"	0.015/.0006"	0.008/.0003"

**Blind Hole Plugs (DP10 - DP5)**

**3.2-6.4mm / .125-.250"**

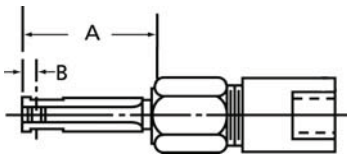

Minimum recommended hole length: 3.96mm / .156in.

**6.4-11.1mm / .250-.437"**

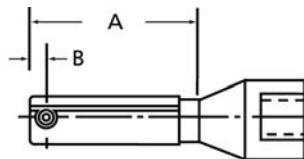

Minimum recommended hole length: 3.18mm / .125in.

**11.1mm & Up / .437" & Up**

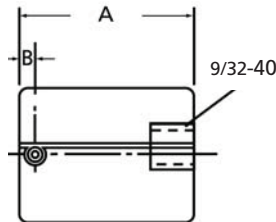

Minimum recommended hole length: 3.18mm / .125". Use AHA-23 or -24 Extensions for deep hole applications.

**Blind Hole/Counterbore Plugs**

Measured Size mm/inch		Minimum Hole Length*		Measuring Range		
From	To & Include	"A"	"B"	DP10	DP5	
3.2/.125"	6.4/.250"	21.4/.844"	2.4/.094"	3.9/.156"	0.015/.0006"	0.008/.0003"
6.4/.250"	11.1/.437"	27.8/1.094"	2.4/.094"	3/.120"	0.015/.0006"	0.008/.0003"
11.1/.437"	76.5/3.010"	27.8/1.094"	2.4/.094"	3/.120"	0.015/.0006"	0.008/.0003"

**Super-blind Plugs**

Blind Hole Air Plugs can be furnished to check shorter holes than listed above, and can be furnished to check closer to the bottom of a hole. Holes must be at least 1.9mm/.075in long, and the distance from the end of the plug to the center-line of the jets can be as short as 1.4mm/.055in for plugs below 6.4mm/.250in or 1.1mm/.045in for plugs above 6.4mm/.250in.

\*If a guide sleeve or stop collar is used, minimum hole length can be as small as 1.1mm / .045in for holes larger than 6.4mm/.250".

### Through Hole Plug (DP100)

#### 9.525-12.7mm/ .375-.500"

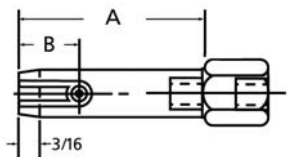

Minimum recommended hole length: 6.35mm/ .250in, with proper support min. is 3.18mm/ .125in. May be used with AEX-1 or -2 Extensions for deep holes.

#### 12.7-37.8mm/ .500-1.490"

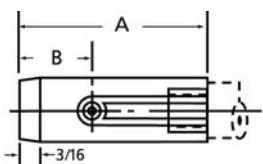

Minimum recommended hole length: 6.35mm/ .250in, with proper support min. is 1.14mm/ .125in. May be used with AHA-4 or -5 Extensions for deep holes.

#### 37.8-76.5mm/ 1.490-3.004"

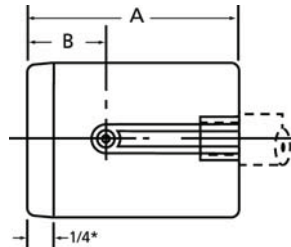

Minimum recommended hole length: 6.35mm/ .250in.

May be used with AHA-4 or -5 Extensions for deep holes.

#### 76.5mm & Up/ 3.004" & Up

Minimum recommended hole length: 6.35mm/ .250in.

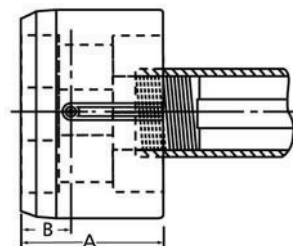

#### Through Hole Plugs

Measured Size mm/inch				Minimum Hole Length*	Measuring Range
Above	To & Include	"A"	"B"		
9.525/.375"	12.7/.500"	38/1.5"	12.7/.500"	6.4/.250"	0.152/.006"
12.7/.500"	37.8/1.490"	41.3/1.626"	15.9/.625"	6.4/.250"	0.152/.006"
37.8/1.490"	76.5/3.004"	50/2"	19/.750"	6.4/.250"	0.152/.006"
76.5/3.004"	114/4.5"	50/2"	19/.750"	6.4/.250"	0.152/.006"

### Blind Hole/Counterbore Plugs

#### 9.525-14.25mm/ .375-.561"

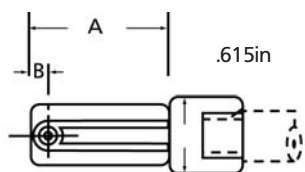

Minimum recommended hole length: 7.9mm/ .312in.

#### 14.25-37.8mm/ .561-1.490"

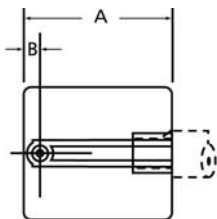

Minimum recommended hole length: 7.9mm/ .312in. Use with AHA-4 or -5 handles for deep hole applications.

#### 37.8-76.3mm/ 1.490-3.004"

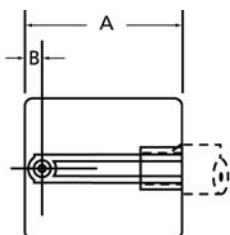

Minimum recommended hole length: 7.9mm/ .312in. Use with AHA-4 or -5 handles for deep hole applications.

#### 76.3-108.2mm/ 3.004-4.500"

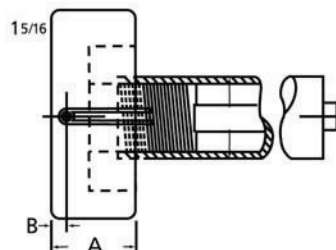

#### Super-blind Plugs

Blind Hole Air Plugs can be furnished to check shorter holes than listed above, and can be furnished to check closer to the bottom of a hole. Holes must be at least 4.45mm/.175in long, and the distance from the end of the plug to the center-line of the jets can be as short as 2.5mm/.100in

#### Blind Hole Plugs

Measured Size mm/inch				Minimum Hole Length*	Measuring Range
Above	To & Include	"A"	"B"		
9.525/.375"	14.1/.556"	30/1.187"	4.7/.187"	7.9/.312"	0.152/.006"
41.5/.556"	37.8/1.490"	30/1.187"	4.7/.187"	7.9/.312"	0.152/.006"
37.8/1.490"	76.3/3.004"	36.5/1.438"	4.7/.187"	7.9/.312"	0.152/.006"
76.3/3.004"	114/4.500" */**	36.5/1.438"	4.7/.187"	7.9/.312"	0.152/.006"

Notes: \*If a guide sleeve or stop collar is used, minimum hole length can be as small as 1.8mm/.070in for holes larger than 6.3mm/.248in.

\*\*A handle 152mm/6in long and 33.3mm/1.31in diameter is supplied with plugs over 76.5mm/3.010in

For smaller or larger plugs than those shown above, or for any modification to the specifications shown, contact Mahr Federal Customer Resource Center.

## Measuring Deep Holes with Air Plugs

### Non-Relieved Air Plugs

When precise plug alignment must be maintained through the entire length of a deep hole, Non-Relieved Air Plugs can be provided. The entire length of these plugs is held to the clearances of Air Plugs described on page 4. Extra lengths of up to 101.85mm/4.010in can be provided for plugs from 6.3mm/.248in to 63.75mm/2.510in diameter. Contact Mahr Federal Customer Resource Center to specify Non-Relieved Air Plugs.

**Small:** 4.75mm/.187in to 9.4mm/.370in (Through Hole Plugs) and 4.75mm/.187in to 11.86mm/.467in (Blind Hole Plugs). Plugs are provided as a solid piece, with the "A" dimensions held to Air Plug clearances, and the remainder machined to a slightly smaller diameter.

Contact Mahr Federal Customer Resource Center to specify Air Plugs in these sizes.

### Relieved Air Plugs

When only the "A" length dimensions (see pages 10 thru 13) need to be held to Air Plug clearances, several options exist, depending on the size of the hole being measured:

**Larger Bores:** Both Through Hole and Blind Hole Plugs larger than 9.53mm/.375in have no shoulder to prevent deep hole gaging, and require using either handles or extensions to facilitate gaging.

### Extended Range Air Plugs – Oil Industry

Air tooling is available for measuring long bores, such as pump barrels used in the oil field industry. The tooling is modified to have up to a 0.254mm/.010in total range. It carries a DPS model number and is basically 2500:1 tooling with extra clearance, a 1/4in polished, trailing and leading edge radius, as well as a full .006in thickness on diameter of hard chrome plate for increased wear life.

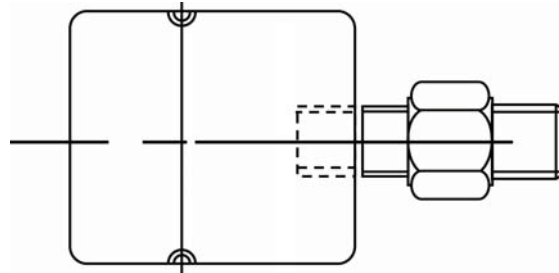

The tooling is designed for use on model DA-SPEC-190 Dimensionair® with a choice of three available ranges:

- 5-0-5: ±0.127mm/±.005in
- 8-0-2: +0.200/-0.050mm, +.008/-.002in
- 9-0-1: +0.225/-0.025mm, +.009/-.001in

The plugs are typically used with a 30ft long hose. AHO-SPEC-102 is a rubber hose and AHO-SPEC-175 is a heavy duty hydraulic hose. The system is ideal for accurately measuring size within ±.005in of zero, but also when extended range is needed for approach and over or to monitoring bore wear typical for pump barrels.

### Contact Style Air Plugs

Mahr Federal's Dimentron® Plugs can be used with 2500:1 Dimensionair systems as a 2-point contact type Air Plug.

AirProbe® and Handle Assemblies for these Plugs are available in three ranges:



Model	AirProbe (included)	Range mm/in	Matching Dial for Dimensionair Amplifier	
			Metric	Inch
AAT-192	AA-2-3	0.076/.003"	ADL-28	ADL-95
AAT-194	AA-2-6	0.152/.006"	ADL-16	ADL-96
AAT-193	AA-2-15	0.381/.015"	ADL-20	ADL-97

Assembly includes AirProbe, AD-140 Adaptor, HA-88 Handle, AL-1737 Flat Contact Point, and AHO-1 Hose. Order Dial separately.



## Dimensionair® Air Gages

### Accessories

#### Handles and Extensions

When an Air Plug is used with a hose, it should be equipped with a Handle to avoid excessive strain on the air connection and corrosion on the polished plug body. Handles may be combined for gaging deep holes.

Selection of a handle or extension is determined by the bore itself and whether or not it is preceded by a larger C-bored diameter. Corresponding thread sizes of the handle or extension must also be considered.

If no portion of the handle or extension enters the part, only thread sizes must be considered. If the plug does enter the part, then both O.D. and thread size must be considered.

AHA-4 and AHA-5 Extensions – accept AHO-1 Hose on one end and the following plug sizes on the opposite end: all 1250:1 thru 8000:1 plugs up to 76.45mm/3.010in (except 2500:1 thru 8000:1 blind hole plugs with 9.53mm/.375in – 11.86mm/.467in diameters).

AHA-6 Handle – accepts AHO-1 Hose on one end and the following plug sizes on the opposite end: all 1250:1 thru 8000:1 plugs up to 76.45mm/3.010in (except 2500:1 thru 8000:1 blind hole plugs with 9.53mm/.375in – 11.86mm/.467in diameters). Has Bakelite insulating cover. Recommended for 37.85mm/1.490in up to 76.45mm/3.010in diameters.

2237666 – High impact and coolant resistant, light weight composite handle – normally furnished with uDimensionair and air snaps.

AHA-66 and 2236070 – light weight aluminum handles without or with air shutoff valve.

AHA-15 Handle – Used and furnished with 1250:1 thru 8000:1 through or blind hole plugs.

AHA-23 and AHA-24 Handles – Used with 10000:1 thru 32000:1 plugs.

AHA-28 Handle – Used with 2500:1 thru 8000:1 Blind hole plugs in the 9.47mm/.373in to 11.86mm/.467in range, using an AAD-315 Adaptor.

AEX-1 and AEX-2 Extensions – Used with 2500:1 thru 8000:1 Through hole air plugs in the 9.5mm/.3735in to 14.1mm/.556in range and with 11.86mm/.467in to 14.1mm/.556in range blind hole plugs, using an AAD-55 Adaptor.

2201975 – extension used with BA-100 adjustable base. Provides easily configured base for bench-mounted air tooling fixturing.

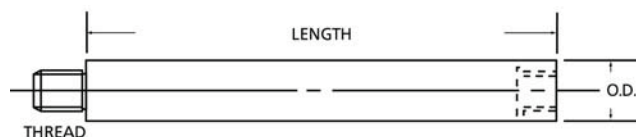

Order no.	Thread	O.D. mm/in	Length mm/in
AHA-4	3/8-32	12.07/.475"	102/4"
AHA-5	3/8-32	12.07/.475"	51/2"
AHA-6	3/8-32	25/1.0"	102/4"
AHA-15	1-1/8-18	33.4/1.315"	152/6"
AHA-20	3/8-32	12.7/.500"	144.8/5.70"
AHA-23	9/32-40	9.14/.360"	51/2"
AHA-24	9/32-40	9.14/.360"	102/4"
AHA-28	10-32	9.14/.3603"	102/4"
AEX-1	5/16-32	9.02/.355"	51/2"
AEX-2	5/16-32	9.02/.355"	102/4"
2201975*	3/8-32	9.5/.374"	61.7/2.43"

\* Use on BA-100

Accessory Configuration for DP60/DP50/DP20 Systems – Low Magnification

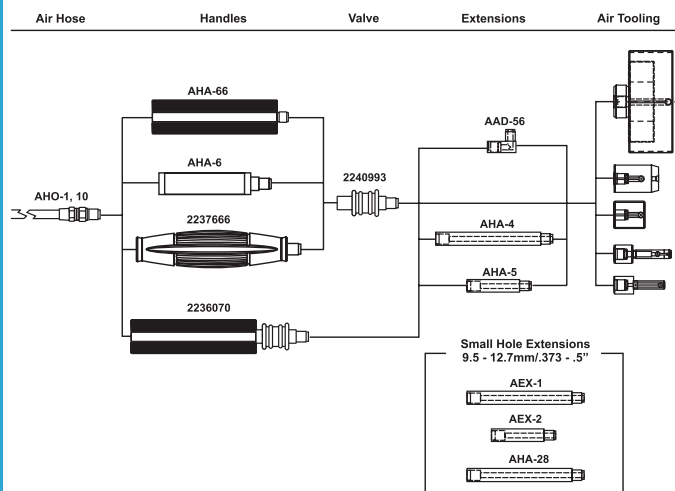

Accessories for High Magnification Systems – DP10/DP5

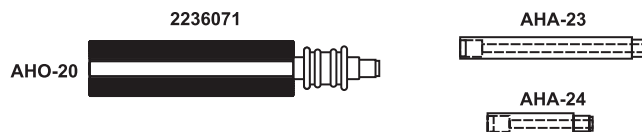

## Dimensionair® Air Gages

### Options for Air Plugs

#### Materials:

Air plugs are normally furnished in High Chrome contain stainless steel or can be flashed chromed for extra protection. Mahr Federal can manufacture air plugs in other materials for extreme use applications. Materials

can include CMP-10, Ferritec, Tungsten carbide ware strips and others are available to get the most from your air gage tooling.

#### Non-relieved air plugs

Normally when using an air plug in a deep hole extensions are combined with the plug to reach the botom of the bore. In some cases lands and interruptions can interfere with plug movement. In these case a non-

relieved plug can be specified. Here the plug is made to a specific length ( in 1 inch increments) so the the land will help guide the plug through the part.

#### Special Jet locations/multiple bore diameter

For certain blind hole applications the location of the jets are critical to measuring the diameter at precisely the location as called out on the part print. Special jet locations can be called out as part of the plug requirements. Or, requirements may call of multiple diameters (the same or different) To be measured simultaneously. Special plugs have multiple jets at different diameter positions can speed up the gaging process.



#### Special shapes

Air tooling for precision bores are by far the most common air gaging application. However, air tooling can be configured to meet virtually any gaging requirements. These may include square plugs, plugs for measuring partial chords in a ball socket or "mouse gages" designed to measure and explore slot widths in parts.



#### Guide pins

For rifle bores or specific part orientation grooves may be incorporated into the part. Guide pins can be attached to the plug to guide the plug and orient the

jets to assure fast easy plug alignment to the surface to be gaged.

#### Marking and kit bundling

Often tooling is purchased as a package for specific applications. Kits can be created that include the air plug and master all contained in a storage box and all individual items marked to include the specific kit number, operation to be used and serial numbers.



#### Special front ends

The leading edge of the air plug is critical for either making entry into the part easy or aligning the part to the bore - as in the case of a shallow bore. Normally an easy entry nose cut out is provided for standard

through hole applications. There are times when a straight entry lead is required. Prints provided at the time of requesting the quote will help in configuring these applications.

#### Stop Collars

For precisely positioning the plug at specified depths a stop collar is the effective solution. These inexpensive options are a must for short bores. They position the measuring jets at the proper location while assuring the plug is square to the bore. See page 46 for selecting a Stop Collar.



## Dimensionair® Air Gages – Air Rings

Air rings are supplied in several styles for external measuring. Two and three jet rings are most common, used for checking outside diameters for sizes out of round conditions from 6.3mm/.248in to 63.5mm/2.500in. Four and six jet rings are also available for special applications. All Air Rings have chrome-plated wear surfaces unless otherwise specified.

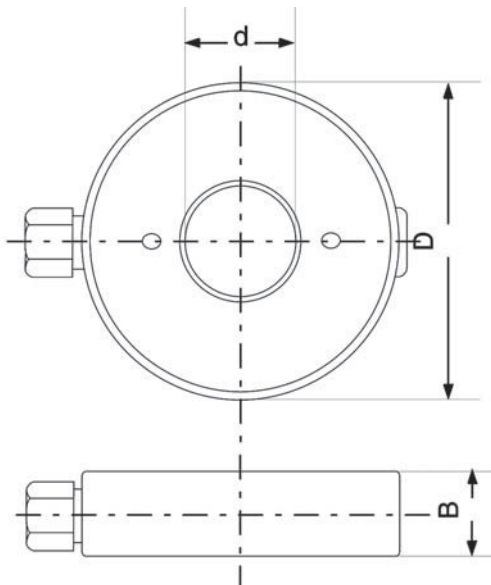

Jet air ring gage with 2 measuring jets

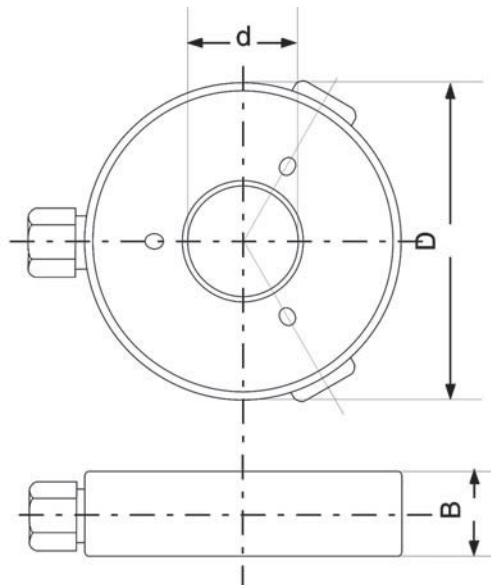

Jet air ring gage with 3 measuring jets

For applications where O.D.'s need to be checked near a shoulder, or where part length is restricted, contact Mahr Federal for technical assistance about shoulder and SnoutType Air Rings.

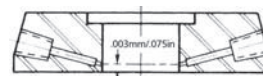
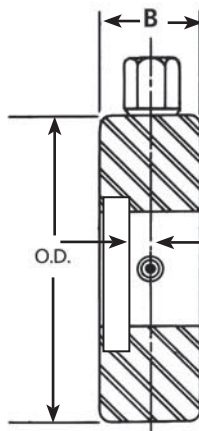

Shoulder Type  
(for 2500:1 & 4000:1  
5000:1 & 8000:1 only)

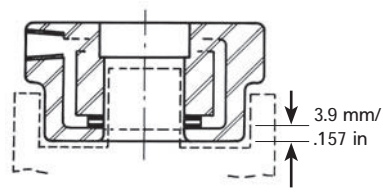

Snout Type

Diameter d mm/in	Diameter D mm/in	Width B mm/in
6.3-7.6/ .248-.299"	76.2/ 3.00"	25.4/ 1.00"
7.6-9.3/ .299-.366"	76.2/ 3.00"	25.4/ 1.00"
9.3-13.0/ .366-.512"	76.2/ 3.00"	25.4/ 1.00"
13.0-21.0/ .512-.827"	76.2/ 3.00"	25.4/ 1.00"
21.0-25.4/ .827-1.00"	76.2/ 3.00"	25.4/ 1.00"
25.4-38.4/ 1.00-1.51"	101.6/ 4.00"	25.4/ 1.00"
38.4-44.5/ 1.51-1.75"	101.6/ 4.00"	25.4/ 1.00"
44.5-50.8/ 1.75-2.00"	127.0/ 5.00"	25.4/ 1.00"
50.8-63.5/ 2.00-2.50"	127.0/ 5.00"	25.4/ 1.00"
63.5-76.2/ 2.50-3.00"	139.7/ 5.50"	25.4/ 1.00"

When ordering ring gages, please specify the following:

- Nominal workpiece dimensions
- Tolerance
- Desired magnification
- Instrument used
- Setting plug to be supplied?

Air Rings may be attached directly to a Dimensionair or used on a base and connected to the gage with a plastic hose. Vee type Guide Chutes can be furnished on one or both sides if Air Rings from 6.3mm/.248in through 44.5mm/1.750in. Tube type guide can be furnished on sizes from 6.3mm/.248in through 63.5mm/2.500in.

## Dimensionair® Air Gages

### Options for Air Rings

#### Carbide Wear strips

Air plugs are normally furnished chromed for long life. Other materials can be provided to improve the life of the ring when high volume or grinding grit

may still remain on the part. Materials such as Ferrotic and addition of carbide strips can be provided.

#### Bases for air rings

Depending on the application there are many ways to hold an air ring. They may be hand held and placed over the part if the part is still on the machine. They may be front mounted, horizontally or vertically on the Dimensionair or for larger parts they can be

mounted to a base and held vertically or horizontally. Special bases are available that mount the ring horizontally and incorporate a part lifting mechanism to aid in part removal.

#### Guide chutes

Guide chutes and vees are available in a host of options to improve the inspection process. Vee type guide chutes can be furnished on one or both sides of an air ring from 6.3mm/ .248" through 44.5mm/ 1.75". Other options include tube type guide chutes for sizes 6.3mm/ .248" through 63.5mm/ 2.5". Standard length of the guide chutes are 6.3mm/ 2.5"

and affix to the side of the air ring. Normal length of the chute is 6.3mm/ 2.5". Other options including heavy duty out riggers and universal vee stands can be provided.



### Options for Air Snaps

Since side clearances can present gaging problems with crankshaft diameters or similar applications, Mahr Federal designed a new line of air snaps that make the tough measurements easier and affordable.

We based our new air snap design on our own proven air tooling techniques, known for providing long life and high-resolution in tough shop environments. Now you can measure fixed sizes from 12.5mm/ .49" through 184mm/ 7.25" using D-2500 and D-5000 systems. Widths are typically 19mm/ .75" but can be customized to reach diameters having tight clearances.

Jet locations can be located central in the snap or positioned close to either side for exploring close to a shoulder.

Multiple circuit air snaps are available for speeding the process while checking the journal for size variation, taper, barrel or hourglass shape.



## Dimensionair® Air Gages – AirProbes and JetProbes

## Features

- AirProbes and JetProbes provide modular, convenient gage heads for use in hand-held gages and for designing into fixture gages.
- 9.5mm/.375in bodies provide standardized mounting configurations.
- Compact size allows easy access to hard-to-reach dimensions.
- AirProbes and JetProbes are calibrated for instant use with Dimensionair® systems - just set zero and measure!
- Available in single-probe and matched-probe configurations.



AA-1-3 AirProbe and AAT-19 JetProbe Assembly

## AirProbes

For use where contact-type measurement is required with 2500:1 Dimensionair Systems. AirProbes are available in Regular Action (counter-clockwise meter movement when spindle is depressed) or Reverse Action (clockwise meter movement when spindle is depressed) and in various ranges. When used with Model 2500:1 Dimensionair, the Meter Dial must be speci-

fied to match the AirProbe range (see table below). AirProbe and Dial are color coded - just match the color band on the AirProbe to the colored dot on the Dial to be sure that the AirProbe range matches the readout on the Dimensionair. AirProbes are provided with AAD-55 Straight Adaptor for attaching to Air Hoses.

Order no.	Range	Style/ Color Code***	Matching Dial Model		Graduations mm/in
			Inch	Metric	
AA-1-3*	0.076mm/.003"	Regular/Red	ADL-28**	ADL-95**	1µm/.00005"
AA-2-3*	0.076mm/.003"	Reverse/Red	ADL-28**	ADL-95**	1µm/.00005"
AA-1-6	0.152mm/.006"	Regular/Green	ADL-16	ADL-96	2µm/.0001"
AA-2-6	0.152mm/.006"	Reverse/Green	ADL-16	ADL-96	2µm/.0001"
AA-1-15	0.301mm/.015"	Regular/Yellow	ADL-20	ADL-97	5µm/.0002"
AA-2-15	0.301mm/.015"	Reverse/Yellow	ADL-20	ADL-97	5µm/.0002"
AA-1-30	0.762mm/.030"	Regular/Blue	ADL-24	ADL-98	10µm/.0005"
AA-2-30	0.762mm/.030"	Reverse/Blue	ADL-24	ADL-98	10µm/.0005"

\*.003in Range AirProbes can also be used with 5000:1 Dimensionairs, but the working range is reduced to .0015in.

\*\*These dials are the same as normally supplied on 2500:1 Dimensionairs, except for the color code.

\*\*\*Regular AirProbes have single color band; reverse AirProbes have double color band.

AirProbes can be supplied in matched pairs, either two Regular Action AirProbes or one Regular and one Reverse Action AirProbe. Contact Mahr Federal Customer Resource Center to specify.

## AirProbesJetProbes

JetProbes are similar to AirProbes, except they have an open jet at the end, instead of a contacting spindle. JetProbes are ideal for measuring flatness of surfaces which cannot be touched, or for building into fixture designs where air gaging is called for. JetProbes can be used with 2500:1, 5000:1 Dimensionairs,

and are supplied singly or in matched pairs. Order No. AAT-19 for single JetProbe or AAT-20 for a matched pair. JetProbes are supplied with AHO-1 Air Hose, a zero setting valve, and hardware for mounting to the Dimensionair.

**Dimensionair® Air Gages – Accessories**

**Magnification Kits (1, 2, or 3 Jet Systems)**

Magnification Kits provide a means for checking Amplifier accuracy, traceable to the National Institute of Standards and Technology (NIST). Each Kit contains restrictors that provide pressure characteristics at zero and at both ends of the scale, a calibrated dial diagram and a Certification of Calibration.

Order No.	For use with:	Tooling
AMR-SPEC-136	1250:1	DP/DR100
2094182	1260:1	DP/DR60
AMR-12	2500:1/4000:1	DP/DR50
AMR-13	5000:1/8000:1	DP/DR20
AMR-14	10000:1/16000:1	DP/DR10
AMR-15	20000:1/32000:1	DP/DR5



AMR-12

**Pressure Meter**

Provides a means for assuring Dimensionair is set for optimum operating air pressure. Order No. 2095924.

**Manifolds**

Manifolds allow connecting multiple pieces of air tooling to one Dimensionair. Toggle valves allow activation of the selected tool. Manifolds are compatible with Dimensionairs 1250:1 through 8000:1M Manifolds for use with other Dimensionairs, contact Mahr Federal Customer Resource Center – 1-800-333-4243.

Order No.	Description
AAD-82	2-way Manifold
AAD-83	3-way Manifold
AAD-84	4-way Manifold
AAD-85	5-way Manifold



Manifold AAD-83

**Adaptors**

Adaptors allow interconnections between air tooling such as Air Plugs and Air Rings, Air Probes and JetProbes to Dimensionair readout units.

Order No.	Description	Thread
AAD-55	Straight Adaptor between AirProbes or JetProbes and air hoses.	3/8-32
AAD-59	Right Angle Adaptor between AirProbes/JetProbes and air hoses.	5/16-32
AAD-56	Right Angle Adaptor between Air Plugs and air hoses.	3/8-32
AAD-102	Adaptor between Dimensionair and air hoses – for 1250:1 and 8000:1 (normally furnished on front of Dimensionair unit).	3/8-32
AAD-165	Adaptor between Dimensionair and air hoses – for 10000:1 and 32000:1 (normally furnished on front of Dimensionair unit).	9/32-40



Right Angle Adaptor AT-155

**Model EKT-1230 Universal Air Probe® Adaptor Kit**

Furnished with an Adjustable Bleed Jet (AJT-131) and Hose Adaptor (AAD-201), permitting plugs and probes manufactured by Moore, Edmunds, Sheffield, Standard and Pratt & Whitney to be used with Mahr Federal Dimensionair gages.

**Adaptors for Sheffield Air Plugs**

Adaptors are available to retrofit Sheffield Air Plugs for use with Mahr Federal Dimensionair Models 2500:1 and 5000:1. Use adaptor with bleed when using Dimensionair systems having single master capability. No bleed adaptors can be used with displays having dual mastering functions.

Sheffield Thread	Plug Type Measured size	Order no.	
		With bleed	No bleed
10-32	2.7686mm/ .109" to 12.547mm/ .494"	AAD-194	AAD-313
1/4-28	12.547mm/ .494" to 23.876mm/ .940"	AAD-193	AAD-312
1/2-20	23.876mm/ .940" to 139.7mm/ 5.500"	AAD-195	AAD-314

## Dimensionair® Air Gages

### Hoses

Supply hoses and hoses between Dimensionair and air tooling.

Order No.	Description	Thread
AHO-2	1.5m/5ft Air Supply Hose. Fits all Dimensionair models. (rubber)	7/16-20
AHO-1	0.9m/3ft Air hose for tooling for Models 1250:1 – 8000:1. (Tygon)	3/8-32
AHO-8	1.5m/5ft Air hose for tooling on Models 2500:1 – 8000:1. (Tygon)	3/8-32
AHO-10	1.8m/6ft Air hose for Models 1250:1 – 8000:1. (Tygon)	3/8-32
AHO-20	0.9m/3ft Air hose for tooling on Models 10000:1 – 32000:1. (Tygon)	9/32-40
ARG-1	Replacement O-ring for AHO-1, -8, -10 Hoses and AHA-4, -5, -6, -20 Handles.	
ARG-6	Replacement O-ring for AHO-20 Hose, AHA-23 and -24 Handles.	
ARG-10	For AEX-1, AEX-2 and AHA-28	

### Traps and Filters

Good gaging practice requires clean, dry air for gage performance. Dimensionair Models are furnished with a particle filter. Shop air contains water and oil, which should be removed, using Model **AFL-24** Oil and Water Separator Trap.

Model No.	Description
AFL-10	Particle Filter (normally furnished on all Dimensionair Models). Filter size: 5 microns; Maximum pressure: 250 p.s.i.; maximum working temperature: 175°F.
AFL-24	Oil and Water Separator Trap, includes mounting hardware. Filtering capacity: 99.7% removal of oil and water; filter size: 3-6 microns; maximum pressure: 150 p.s.i.; flow rate: 20 cubic feet of air/minute @ 80 p.s.i.
AFL-23	Replacement cartridge for AFL-24.
AFL-21	Replacement cartridge for AFL-10.
AAD-263	Retrofit Kit for AFL-9



AFL-24 Trap

Dimensionair® Air Gages

### Mounting Brackets for AirProbes® and Jetprobes

Adjustable Mounting Bracket  
Order No. AT-29

Allows for ±7/16in adjustment of probe using a hex wrench.

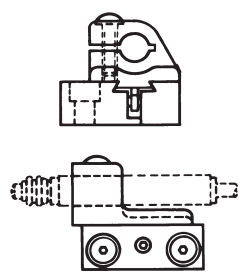

Square Bracket  
Order No. AAD-67  
1/4-20 mounting thread.

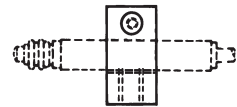

"L" Bracket  
Order No. AAD-66

For mounting AirProbes and other .375in dia. Gage Heads on Comparator Stands.

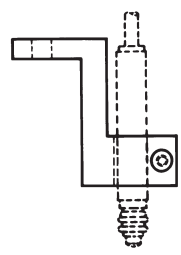

"T" Bracket  
Order No. AAD-91  
Flange mounted, two 4.3mm/.169in through holes.

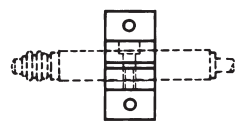

## Dimensionair® Air Gages - Zero Master System

### Features

- Uses regular shop air (40 -150 psig).
- Internal pressure regulator keeps measuring pressures within calibrated range.
- Adjust meter to zero using a single setting master and the zero setting screw.
- High visibility meter has fine line graduations and a needle-thin hand for clear, precise readings. An air filter is included to remove dust and dirt contaminants from air line.
- Tooling mounts to the front of the unit. Connections are tight with finger pressure.
- No recalibration necessary when changing tooling. Just set zero and measure!
- Models available in 5 magnifications, 2 dial styles, and either Metric or Inch.

### Dimensionair Systems

Nine metric models and nine inch models, regular size and large size dials, single and multiple units.

### Air Plugs

Through-hole, Blind hole, and Counterbore styles. Fractional sizes carried in stock for fast delivery. Sizes as small as 3.12mm/.123in (or even smaller on special order). Special configurations for specific applications are available.

### Air Rings

2-jet and 3-jet versions available for external diameters. Sizes as small as 6.3mm/.248in to as large as 76.5mm/3.010in. Other sizes available on special request.

### Size/Measuring Range Chart

Magnification	Plug size Group (mm/in)	Measuring Range (mm/in)
2500:1 & 4000:1	3-3.5/.123-.140"	±0.0127/.0005"
	3.5-4.7/.140-.185"	±0.01905/.00075"
	4.7-6.3/.185-.248"	±0.025/.001"
	6.3-127/.248-5"	±0.038/.0015"
	127-Up/5-up"	±0.038/.0015"
5000:1 & 8000:1	3-3.5/.123-.140"	±0.0064/.00025"
	3.5-4.7/.140-.185"	±0.00953/.000375"
	4.7-6.3/.185-.248"	±0.01905/.00075"
	6.3-127/.248-5"	±0.01905/.00075"

*The long measuring range of the Dimensionair permits a smaller bodied air plug, which provides greater plug clearance. Even with greater clearance, there is no centralizing error.*

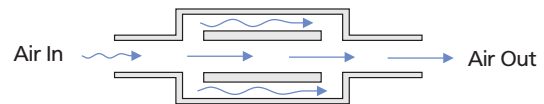

*Unique "silencer" built into every Dimensionair removes air's natural turbulence from the measuring line, resulting in a fast and responsive measuring system.*

### AirProbes® and JetProbes

9.5mm/.375in diameter probes for adapting existing mechanical gages to use the Dimensionair System, or for designing into special fixtures to solve measuring problems.

### Accessories

A complete line of accessories such as hoses, handles, extensions, bench stands, air filters, and calibration kits to extend the usefulness of the Dimensionair System. Master Setting Rings and Plugs - Available from Class XXX to Class Z for setting nominal value.

### Applications Assistance

For special applications\* or for technical assistance, contact Mahr Federal Customer Resource Center — **1-800-333-4243**.

*\* For applications where the local elevation is greater than 305M/1000 feet, special calibration is required.*



## Dimensionair® Air Gages

## Dial Styles

**Dial Sizes: Regular Dials** 82.6mm/3.25" diameter  
**Large Dials** 152.4mm/6" diameter

**Housing Dimensions** 127mm x 187mm x 197mm(high)  
 5" x 7.125" x 7.75"

**Weight (including filter)** approx. 6.7kg/14.25 lbs.

**Operating Pressure** 276-1034kPa/40-150 psig

*Each Dimensionair is furnished with an adaptor (for connecting air tooling to instrument), an air filter and a 1.5m/5ft rubber hose (for connecting to air line or separator trap).*

When choosing your Dimensionair model, consider:

1. Surface finish
2. Part tolerance
3. Accuracy/minimum graduation requirements
4. Length of measurement surface

Magnification	Tooling ID no.	Range	Minimum Graduation	Dial Style	Surface Finish (recommended)	Part Tolerance (recommended)	Order no.
1250:1	100	.006"	.0001"	Regular	100	±.002"	2095183
2500:1	50	.003"	.00005"	Regular	50	±.001"	2095184*
5000:1	20	.0015"	.00002"	Regular	20	±.0005"	2095185*
10000:1	10	.0006"	.00001"	Regular	10	±.0002"	2095186
20000:1	5	.0003"	.000005"	Regular	5	±.0001"	2095189
1250:1M	100	152µm	2µm	Regular	100	±50µm	2095190
2500:1M	50	76µm	1µm	Regular	50	±25µm	2095191*
5000:1M	20	38µm	0.5µm	Regular	20	±13.5µm	2095192*
10000:1M	10	15.2µm	0.2µm	Regular	10	±5µm	2095193
20000:1M	5	7.6µm	0.1µm	Regular	5	±2.5µm	2095194
4000:1	50	.003"	.000025"	Large	50	±.001"	2095195*
8000:1	20	.0015"	.000010"	Large	20	±.0005"	2095196*
16000:1	10	.0006"	.000010"	Large	10	±.0002"	2095197
32000:1	5	.0003"	.000005"	Large	5	±.0001"	2095198
4000:1M	50	76µm	0.5µm	Large	50	±25µm	2095199*
8000:1M	20	38µm	0.2µm	Large	20	±13.5µm	2095200*
16000:1M	10	15.2µm	0.2µm	Large	10	±5µm	2095201
32000:1M	5	7.6µm	0.1µm	Large	5	±2.5µm	2095202

*Regular Dial Dimensionair units are available with 2 or 3 multiple displays.*

*\* Contingent upon plug having equivalent range, see chart on previous page.*

## Accessory

## Protective Cover

Order no.

A plastic protective cover for Dimensionairs is available.

ACV-1.

Dimensionair® Air Gages

Dial Styles for Dimensionair Gages

Regular Dials

Inch models with soft green tint; metric models with yellow tint.

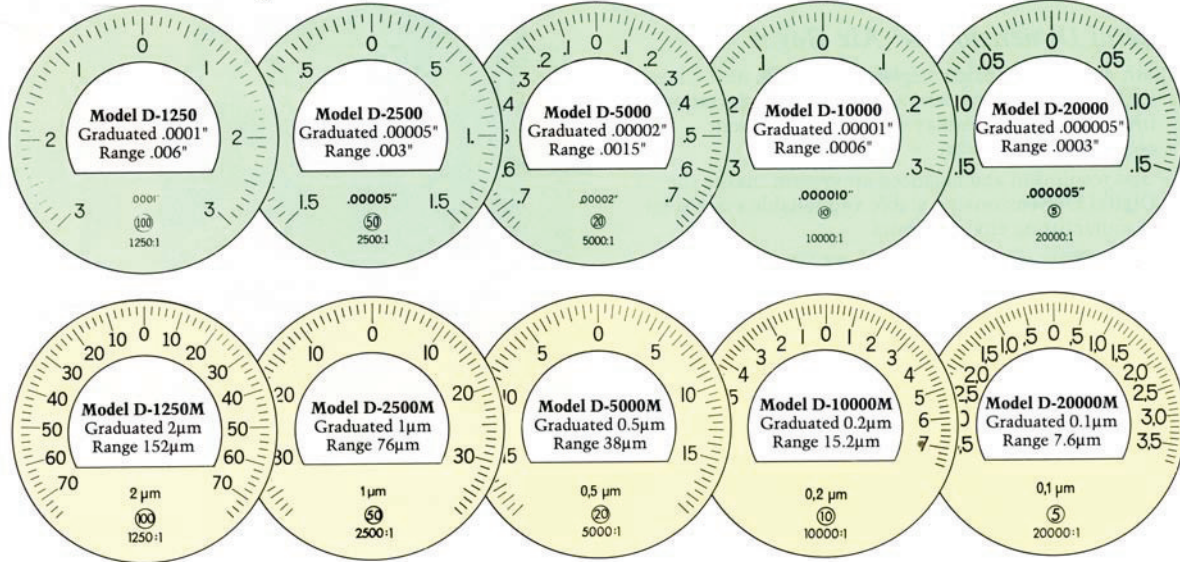

Large Dials

(Inch models with soft green tint; metric models with yellow tint)

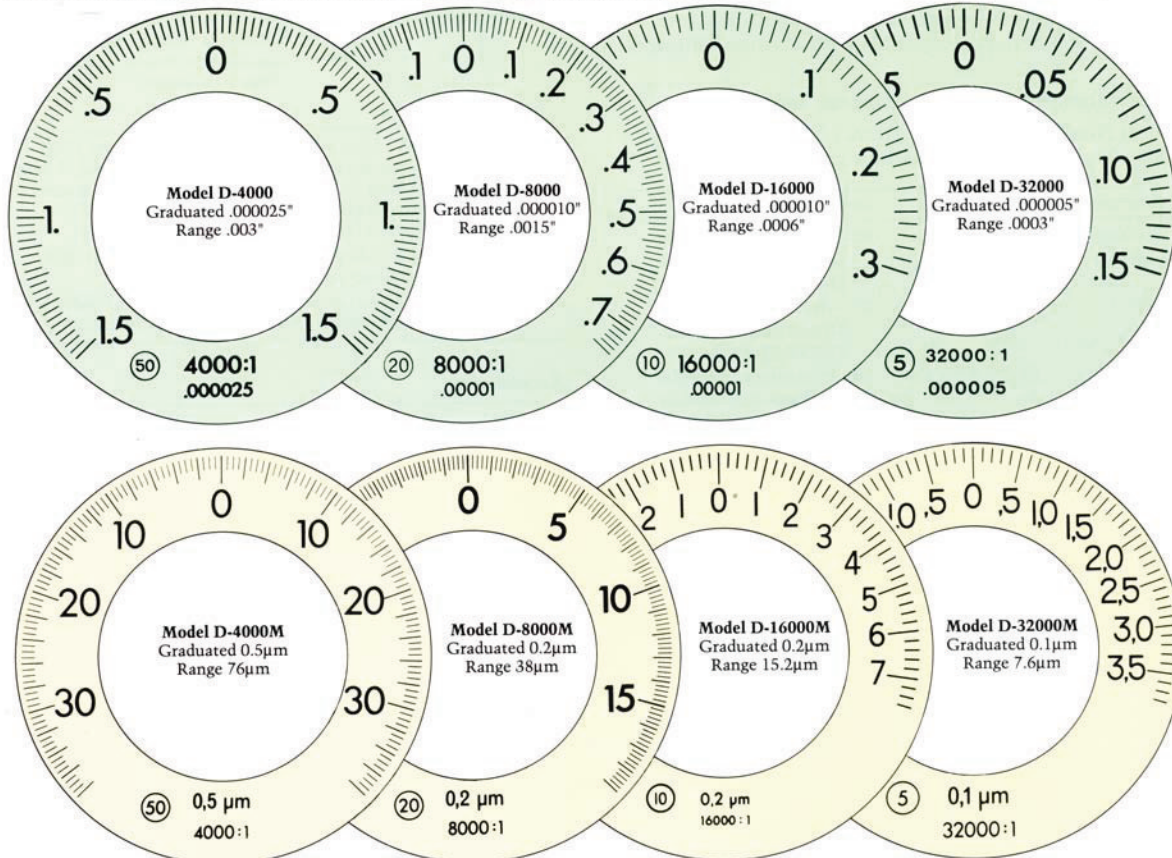

## Universal Dimensionair® Air Gaging Comparator (zero plus Min./Max. Master System)

Selecting either a single or dual master gaging system involves trade offs. The single master system is simple and economical to operate while the dual master system offers greater flexibility with the requirement of limit masters.

Mahr Federal can now provide the essential high quality air gage tooling to satisfy both gaging requirements. The Universal Dimensionair is part of a new series of adjustable magnification air comparators from Mahr Federal. Based on the precision of the standard Dimensionair - the new model offers the ability to work both as a single master or dual master air gaging system.

When calibrated with Mahr Federal restrictor kits for 2500:1, the Universal Dimensionair maintains the same performance and stability as a standard 2500:1 Dimensionair. Use it with your Mahr Federal tooling and one master for fast single mastering air gage applications.

With built in magnification and zeroing controls the Universal Dimensionair also takes on the role of a dual master air gage comparator. Select the appropriate dial configuration and use it with virtually any dual master air tooling and span masters to master the gaging span to the meter. Usually, product tolerance limits are selected as the mastering dimensions, assuring that parts can be easily classified as good or bad within the range of the comparator.

The user sets system sensitivity (scale factor) by adjusting the air comparator span to correspond to the difference between minimum and maximum setting masters, thus setting the sensitivity of all the components of the gaging system.

### Features

- Uses regular shop air (40 -150 psig).
- Internal pressure regulators and differential meter assure ultimate stability over full operating range.
- Adjust span and zero setting to tune the gaging range to the interchangeable dial ranges.
- Interchangeable dials - dials provide an easy, inexpensive means to accommodate various ranges.
- High visibility meter has fine line graduations and a needle thin hand for clear, precise readings.
- An air filter is included to remove dust and dirt contaminants from airline.
- Tooling mounts to the front of the unit. Adaptors are available for virtually any tooling configuration.



*Interchangeable Dials*



## Universal Dimensionair® Air Gaging Comparator

### Technical Data

Dial Size	82.6mm/3.25in diameter
Housing Dimensions	127mm x 187mm x 197mm(high) 5in x 7.125in x 7.75in
Weight (including filter) approx.	6.7kg/14.25 lbs.
Operating Pressure	414-1034kPa/60-150 psig

A plastic protective cover for Universal Dimensionair is available Order No. **ACV-1**

*Each Universal Dimensionair is furnished with an adaptor (for connecting standard Mahr Federal air tooling) Optional adaptors are available for virtually any air tooling application.*

### Ordering Information

Universal Dimensionair, complete with air filter and tooling adaptor for standard Mahr Federal single master air tooling. Supplied with one **2242662** Dial. **Order No. 2098125**

#### Optional Dials

	Total Range	Range	Dial Graduations	Magnification	Order No.
(Inch)	.006"	±.003"	.0001"	1250:1	2242760
	.004"	±.002"	.0001"	1875:1	2242761
	.003"	±.0015"	.00005"	2500:1	2242762
	.002"	±.001"	.00005"	3750:1	2242763
	.0015"	±.00076"	.00002"	5000:1	2242764
	.001"	±.0005"	.00002"	7500:1	2242765
	.0006"	±.0003"	.00001"	10000:1	2242766
(Metric)	152µm	±76µm	2µm	1250:1	2242770
	100µm	±50µm	2µm	1875:1	2242771
	76µm	±38µm	1µm	2500:1	2242772
	50µm	±25µm	1µm	3750:1	2242773
	38µm	±19µm	0.5µm	5000:1	2242774
	15.2µm	±7.6µm	0.2µm	10000:1	2242776

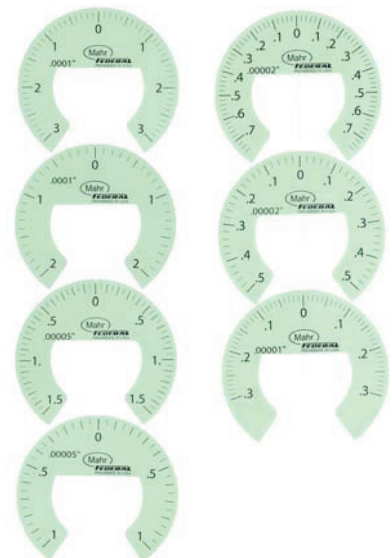

#### Tooling Adaptors

Adaptors are available for many standard-tooling configurations:

Thread/Adaptor style	Plug Type Measured size	Order No.
1/4-28	2.7686mm/.109" to 12.547mm/.494"	AAD-193* AAD-312
10-32	12.547mm/.494" to 23.876mm/.940"	AAD194* AAD-313
1/2-20	23.876mm/.940" to 139.7mm/5.500"	AAD-195* AAD-314
1/8 Barb	3/8-32 Female	2242767
Setlock	Moore	2242777
8mm	Mahr Row	2240621
12mm	Mahr Row	2240623
9/32-40	Mahr Federal High Mag	

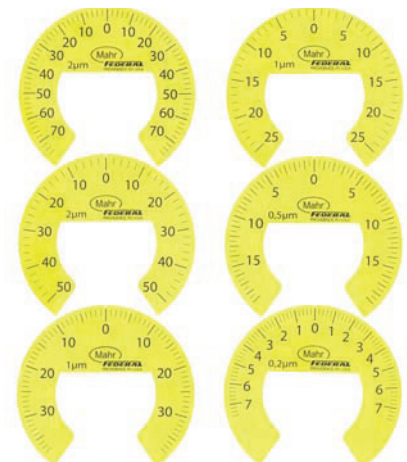

\* Includes bleed to simulate MFI jetting.

## μDimensionair® (zero Master System)

### Features

#### • Affordable • Versatile • Innovative • Rugged

No other air gaging system offers so much – in the palm of your hand – mounted to the workbench or even right to the machine tool. μDimensionair is rated IP-54, so, it can be used on the shop floor – and, the air tooling cleans dirt from the part for high performance measurements – fast and easy!

- Air gage readout is right in front of you – simple and clear.
- Fixed resolution and balanced air system makes the gage stable and reliable for your manufacturing environment.
- Single mastering for fast setup.

All other features of the μMaxμm Digital Indicator:

- Inch/metric units
- Digital and analog display
- Bi- and uni-lateral tolerances with presets
- Absolute transducer for eliminating travel errors
- Calibratable – battery retains settings
- Multiple data output formats
- Auto-zeroing
- Normal-reverse settings for ID/OD measurements



*The μDimensionair is the ultimate of portability and versatility – in your hand or at the workbench or machine tool. Shown with optional 2239307 Bench Kit*

### Versatility

The ultimate in configuration – interchangeable handle allows for pistol grip or normal end-mount for easy application of the plug to the part. For large, heavy plugs, mount the handle between the tooling and the display – assures a well-balanced, ergonomic measuring system. Can also be mounted to a bench stand when parts are brought to the gage.



*All parts of the μDimensionair are completely interchangeable and included with the gaging system – versatility is built-in.*

*All μDimensionair gages are supplied with output capability.*

### Accessories



*Bench stand provides safe and secure μDimensionair storage between measurements.*

**Order no. 2241109**



*Slide valve controls air to tooling – saves cost of wasted air, reduces air noise.*

**Order no. 2240993**



*Swivel coupling allows for rotating tooling to fully explore bore.*

**Order no. 2240594**

*For applications where the local elevation is greater than 305M/1000 feet, special calibration is required.*

**μDimensionair® Air Gages**
**Technical Data**

Measuring Range	Digital Resolution	Tooling I.D. Number
± 0.080mm/± <b>0.003"</b>	0.001mm/ <b>0.00005"</b>	60
± 0.040mm/± <b>0.0016"</b>	0.0005mm/ <b>0.00002"</b>	50
± 0.020mm/± <b>0.0007"</b>	0.0005mm/ <b>0.00002"</b>	20

Operating Temperature	5-35° C/41-95° F
Storage Temperature	0-60° C/32-140° F
Repeatability	± 1 digit
Calibration Accuracy	± 1 digit
Linear Error	± 1 digit
Response Time	Approximately 1 second
Thermal Stability	0.1% of full scale/F
Data Output	ASCII/Digimatic
Tolerance Indicators	Two – over/under
Weight	25kg/5.5lbs.
Dimensions	Main body – approximately 100 x 60 x 70mm/4 x 2.5 x 3 in
Auto Power Off	15 minutes of non-use
Power Requirements	3 volt lithium battery coin cell, 2 per unit – CR-2450
Battery Life	9 months normal usage – 3000 hours
Air Supply	2.10 ±.01 bar/30.4 ±.15 psi
Display	Rotates through 270 degrees

Ordering Information	Order Number
μDimensionair, complete with handle, adaptor and hose	<b>2095389</b>
Pressure Regulator with filter	<b>2238020</b>
Pressure Meter	<b>2095924</b>
Bench Kit with adaptor	<b>2239307</b>
Output cable – Digimatic	<b>2001025</b>
Serial output cable to DB-9 pin	<b>SCB-4</b>
Battery 3V type CR-2450	<b>EBY-1018 or 4102520</b>
Insulated Handle	<b>2237666</b>
Shut off slide valve	<b>2240993</b>
Rest Stand	<b>2241109</b>
Swivel coupling Adaptor	<b>2240594</b>
Air Regulator Trap	<b>AFL-24</b>

## Dimensionair® Air Gages (zero plus Min./Max. Master System)

### Column format air measuring systems



Assess and judge single or dual mastering type measuring results at a glance – nothing is easier than that with the Millimar S 1840 column amplifier.

The Millimar S 1840 column amplifier offers a broad range of functions for combining the signals from both static and dynamic measurements.

Measuring results are indicated by way of 101 three-color LEDs. When the programmable warning and tolerance limits are exceeded, the LEDs change their color from green to yellow or red, accordingly – high visibility from any distance.

#### Features

##### Display

- Three-color illuminated bar graph with analog warning and tolerance limit display
- Two-line backlit LCD for indicating measured values, help texts, and measuring units
- Up to two characteristics can be displayed simultaneously.

##### Connections

- Single input.
- RS 232 interface.
- Analog output.
- Three digital inputs for measuring start, master measurement, etc.
- Three digital outputs for Accept – Reject – Rework classification, measuring time, etc.

##### Functions

- Static measurements:  $\pm A$ ,  $\pm B$ , and all combinations.
- Dynamic measurements: Max, Min, Max-Min, Max+Min, mean.
- Single Master or Dual Master setup.
- Password lockout in Setup Mode.

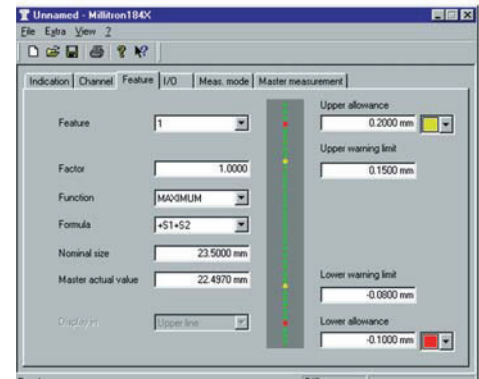

The Millimar S 1840 column amplifier can be programmed either menu-guided via the integrated membrane keypad or with MS Windows® configuration software.

### Technical Data

#### Air/electronic converter for Millimar S 1840 PE

Measuring principle	differential pressure		
Measuring value acquisition	piezo		
Magnification	2500:1	5000:1	10000:1
Pneumatic measuring range in $\mu\text{m}$ (in)	+/- 50	+/-25	+/-12.5
Digital resolution (adjustable)	0.01mm/0.0001", 0.001mm/0.00001" 0.0001mm/0.000005"		
Measuring error in $\mu\text{m}$ (in)	< 1 % of measuring range, better 0.5 %		
Signal noise in $\mu\text{m}$ ( $\mu\text{in}$ )	$\leq 0.4$ (15.748)	$\leq 0.2$ (7.874)	$\leq 0.1$ (3.937)
Setting time in sec. (1 m/3.3 ft hose)	$\leq 0.3$	$\leq 0.3$	$\leq 0.5$
Setting time in sec. (2 m/6.6 ft hose)	$\leq 0.5$	$\leq 0.5$	$\leq 0.7$
Operating temperature	0 ... 40 °C (32 ... 104 °F)		
Supply pressure	2 bar +/- 5 % (> 4 bar before pressure reducer)		

Air supply connection	PU hose, dia 8 x 1 (.315 x .0394 in)
Measuring air connection	PU hose, dia. 6 x 1 (.236 x .0394 in)
Zero setter (OFFSET)	electrical
Amplification (GAIN)	electrical
Air consumption	approx. 1-2 m <sup>3</sup> (1.308-2.616 cu.yd.)

#### Tooling I.D.

Millimar S1840PE/F:	low magnification	for 1 Air Gage 2500:1 without Regulator	50	<b>5330104*</b>
		for 1 Air Gage 5000:1 without Regulator	20	<b>5330105*</b>
	High magnification	for 1 Air Gage 10000:1 without Regulator	10, 5	<b>5330106*</b>
Accessories:	Basefoot	With 1 Regulator for 1 1840PE Column Unit		<b>5330910</b>
		With 2 Regulators for 2 1840PE Column Units		<b>5330911</b>
		With 3 Regulators for 3 1840PE Column Units		<b>5330912</b>
	Air Supply Adaptor Kit	Includes AFL-24 Filter and AHO-2 Hose		<b>2121236</b>

For applications where the local elevation is greater than 305M/1000 feet, special calibration is required.

\* Base with Regulator required and sold separately. Air Supply Kit recommended.

**832 Dimensionair® Air Gaging (zero master system)**

**Features**

- Digital and analog displays in a single unit. Large, high contrast digital readout shows exact deviation from zero; analog display shows measurement conditions at a glance.
- Fixed resolution and balanced air system makes the Digital Dimensionair a stable and reliable system for manufacturing environments.
- Only a single master required to set zero; system is precalibrated for correct magnification.
- Ranges and resolutions for virtually any air gage application, including 2-, 3-, 4- and 6-jet tooling plus AirProbes and JetProbes.
- Dynamics measurement capability.
- RS-232 Output – for communicating with a data collector, computer or printer, permitting statistical process control.
- Master Deviation – enhances measurement by making Auto Zero even more accurate.



**Technical Data**

Model	Measuring Range	Digital Resolution	Analog Resolution	Tooling I.D. Number
<b>Low Magnification Single or Dual Input</b>	$\pm 0.080\text{mm} / \pm .003''$	0.0002mm/ <b>10<math>\mu</math>''</b>	0.004mm/ <b>150<math>\mu</math>''</b>	60
	$\pm 0.040\text{mm} / \pm .0015''$		0.002mm/ <b>75<math>\mu</math>''</b>	50
	$\pm 0.020\text{mm} / \pm .00075''$		0.001mm/ <b>38<math>\mu</math>''</b>	20
<b>High Magnification Single or Dual Input</b>	$\pm 0.008\text{mm} / \pm .0003''$		0.0004mm/ <b>15<math>\mu</math>''</b>	10
	$\pm 0.004\text{mm} / \pm .00015''$	0.0001mm/ <b>5<math>\mu</math>''</b>	0.0002mm/ <b>8<math>\mu</math>''</b>	5

<b>Operating Temperature</b>	5~35° C/41~95° F
<b>Storage Temperature</b>	0~60° C/32~140° F
<b>Repeatability</b>	$\pm 1$ digit or $\pm 1\%$ of range, whichever is greater
<b>Calibration Accuracy</b>	$\pm 1$ digit*
<b>Linear Error</b>	$\pm 1$ digit
<b>Response Time (Electronics)</b>	43 msec.
<b>Response Time (Air))</b>	approx. 1 sec. (dependent on hose length of air tooling)
<b>Thermal Stability</b>	0.1% of full scale/°F
<b>Digital I/O</b>	five TTL opto-isolated outputs
<b>Data Output</b>	RS-232, transmits Channels A, B, (or both – dual input models only)
<b>Analog Output</b>	$\pm 5$ Vdc full scale for displayed value signal $\pm A, \pm B$
<b>Measuring Modes</b>	Actual, Minimum, Maximum, T.I.R., Nominal
<b>Tolerance Indicators</b>	five LED
<b>Weight (approx.)</b>	11 lbs./5kg
<b>Dimensions</b>	254mmh x 197mmw x 216mmd/10inh x 7.75inw x 10.25ind
<b>Display Modes</b>	A, (or B or both – dual input models only)
<b>Auto Power Off</b>	after 30 minutes of non-use (selectable)
<b>Power Requirements</b>	100 Vac to 240 Vac, 50-60Hz with power module (Furnished)

*Note: All models listed may be ordered for: 1-Jet, 2-Jet, 3-Jet, 4-Jet, or 6-Jet applications. At time of ordering, PLEASE designate the number of jets to be used on the system.*

*\* For applications where the local elevation is greater than 305M/1000 feet, special calibration is required.*



## 832 Dimensionair® Air Gaging System

## Technical Data

Number of Jets	Voltage/Adaptor	Low Magnification Single Input Order no.	High Magnification Single Input Order no.	Low Magnification Dual Input Order no.	High Magnification Dual Input Order no.
1, 2, 3	110/U.S.	2004100	2004103	2004106	2004109
4	110/U.S.	2004101	2004104	2004107	2004110
6	110/U.S.	2004102	2004105	2004108	2004111
1, 2, 3	240/International	2004112	2004115	2004118	2004121
4	240/International	2004113	2004116	2004119	2004122
6	240/International	2004114	2004117	2004120	2004123

## Accessories

Order no.	Description
7024634	RS-232 Cable, Amplifier to MSP-2 Printer or computer, 2m/6ft cable
ECV-1276	Oil/Splash Cover (opaque)–provides protection for the 832 Digital Dimensionair® when used in harsh environments
ECV-1285	Oil/Splash Cover (clear)–provides protection for the 832 Digital Dimensionair when used in harsh environments
ECB-1857	Footswitch for HOLD/RESUME, 3m/10ft cable
ECB-1858	Footswitch for DYNAMIC RESET, 3m/10ft cable
ECB-1859	Footswitch for SEND DATA, 3m/10ft cable
ECB-1855	Pushbutton for DYNAMIC RESET, 1.5m/5ft cable
ECB-1860	Pushbutton for SEND DATA, 1.5m/5ft cable
ECB-1861	Pushbutton for HOLD/RESUME, 1.5m/5ft cable
ECB-1868	Pushbutton for HOLD/RESUME and SEND DATA, 3m/10ft cable
EKT-1236-W3	Relay Box – five relays each with Normally Open/Normally Closed contacts: Contact Rating – 30 Vdc/120 Vac, 3 amps Power Supply – 120 Vac Dimensions – 39mm x 129mm x 134.6mm d/1.53in x 5.08in x 5.3in with ECB-1886-W2*, 6.1mm/24in interconnect cable amplifier/relay box
EKT-1236-W4	Same as W3, except with 220 Vac Power Supply
EKT-1236-W5	Same as W3, except with 240 Vac Power Supply
2010000	Power Supply, U.S. Adaptors (120V)
2010001	Power Supply, International Adaptor (120/240V)

## Mating Connectors

ECN-1695-W2	Digital I/O (15 pin male)
ECN-1693	Reset Data (3/32 microphone plug)
ECN-1695-W1	RS-232 Digital Output (9 pin female)

\* Order ECB-1886-W1 for 305mm/12in interconnect cable, or, ECB-1886-W3 for 914mm/36in cable.

Millimar C 1210 & Millimar C 1245 Zero plus Min./Max. Master System

Millimar C 1210



The pneumatic version of Millimar C 1208 features a built-in air-electronic converter. This enables air gages of different magnifications to be connected directly to the Millimar C 1208.

The ideal instrument for performing simple measuring tasks quickly.

The large, clear LCD display with results indicator, tolerance markers and a two-line digital display, outputs measured values, help texts and units of measurement.

Display

- Back Lit LCD display with quasi analog indicator and two-line digital display.
- 5 three-color status lamps for warning and tolerance limits.
- Up to 2 characteristics can be displayed at the same time.

Functions

- Static measurements:  $\pm A$ .
- Dynamic measurements: Max, Min, Max-Min, Max+Min, Mean value.

Connections

- 1 input for air gages (by model).
- RS232 interface.
- 3 digital inputs for start, master measurement, send measured values, ...
- 3 digital outputs for GO, NO GO, rework, measuring time, ...

For applications where the local elevation is greater than 305m/1000 feet, special calibration is required.

Millimar C 1245



You will significantly improve the cost effectiveness of your measuring devices. The modular design enables the Millimar C 1245 to be adapted easily - even to future measuring tasks. Measuring results can be read with extreme ease from the analog dial indicator.

Display

- Analog indicator instrument for display of measurement value.
- Two-line LCD display for values and menu text
- 5 three-color status lamps for warning and tolerance limits.
- Up to 3 characteristics can be displayed at the same time.

Functions

- 16 characteristics can be defined using an equation editor (80 characters), input channels C1 to C8 are mathematically linked with factors and brackets using the 4 basic mathematical functions.
- Static measurements: Current value, square root, arc tangent.
- Dynamic measurements: Max, Min, Max-Min, Max+Min, Mean value.
- Statistical functions: n, x-bar, S, Xmax, Xmin, R.
- Measured value memory for 5000 measured values.
- Measurement start / stop via keyboard, digital input, RS232.

Connections

- 1 or 2 input for air gages (by model).
- 4 inputs for DC and inductive signals.
- 2 inputs for incremental signals.
- RS232 interface.
- 3 digital inputs for start of measurement, master measurement / zero, send data.
- 6 digital outputs for GO - NOT GO - rework, ALL GO, measuring time, 4 classes, BCD interface.

## Millimar C 1208 &amp; Millimar C 1245

## Measuring Laboratory Precision on the shop floor

## Technical Data

	Millimar 1208	Millimar 1245
Power consumption	11 VA	11 VA
System of protection	IP 53 With conductive dust, IP43	IP 53 With conductive dust, IP43
Casing dimensions (HxWxD)	Approx. 210 mm x 160 mm x 155 mm (8.27" x 6.30" x 6.11")	Approx. 210 mm x 160 mm x 155 mm
Weight	Approx. 1.6 kg	Approx. 2 kg
Tolerance display	5 LEDs, 3-color	5 LEDs, 3-color
Display ranges	± 10 µm, 30 µm, 100 µm, 300 µm, 1000 µm, 3000 µm, 10000 µm ± 0.0001 inch, 0.0003 inch; 0.001 inch 0.003 inch; 0.01 inch; 0.03 inch; 0.1 inch; 0.3 inch or tol.-related	± 10 µm, 30 µm, 100 µm, 300 µm, 1000 µm, 3000 µm, 10000 µm ± 0.0003 inch; 0.001 inch 0.003 inch; 0.01 inch; 0.03 inch; 0.1 inch; 0.3 inch
<b>Resolution</b>	0.1 µm/ .000005" (measured value display)	0.1 µm (measured value display)
Settling time		
- Measured value memory	0.010 s	0.005 s
- Scale display	0.020 s	0.300 s
- Numerical display	0.050 s to 0.300 s	0.050 s to 0.300 s
- Outputs	0.020 s	0.020 s
Error thresholds		
- 10x scale display	2% (51 pixels)	2%
- Digital display	± 0.5%	± 1 digit
Temperature coefficient	± 0.005% / °C	± 0.005% / °C
Operating temperature range	0 °C to 45°C	0 °C to 50°C
Interfaces		
Computers, printers	RS232, 9-pin male (PC-compatible assignment)	RS232, 9-pin male (PC-compatible assignment)
Control outputs	3 optocoupler outputs, 24 V, 10 mA	6 optocoupler outputs, 24 V, 10 mA
Control inputs	3 optocoupler inputs, 24 V, 100 mA	3 optocoupler inputs, 24 V, 100 mA
Millimar C 1208 PE/F	For 1 Air Gage 2,500:1 with Regulator	<b>5312095</b>
Millimar C 1208 PE/F	For 1 Air Gage 5,000:1 with Regulator	<b>5312094</b>
Millimar C 1208 PE/F	For 1 Air Gage 10,000:1 with Regulator	<b>5312093</b>
Millimar C 1245 PE/F	For 1 air gage 2,500:1 with Regulator	<b>5331271</b>
Millimar C 1245 PE/F	For 1 air gage 5,000:1 with Regulator	<b>5331272</b>
Millimar C 1245 PE/F	For 1 air gage 10,000:1 with Regulator	<b>5331273</b>
Millimar C 1245 PE/F2	For 2 air gages 2,500:1 without Regulator	<b>5331275*</b>
Millimar C 1245 PE/F2	For 2 air gages 5,000:1 without Regulator	<b>5331276*</b>
Millimar C 1245 PE/F2	For 2 air gages 10,000:1 without Regulator	<b>5331277*</b>
Air Supply Adaptor Kit	includes AFL-24 Filter and AHO-2 Hose	<b>2121236</b>

\*Baseplate with 2 Regulators (required for 2 Air Gage Units)

**5330909**

**Dimensionair® Air Gages**

**Worksheet for Ordering Air Plugs**

There are two basic styles of Air Plugs, Thru Hole and Blind Hole Styles. Dimension "B" refers to the dimension of the Jet Centerline to the Nose of the Air Plug. The overall dimension is indicated by Dimension "A". There is an option for Super Blind Plugs that further reduces Dimension "B", permitting checking closer to the bottom of the part.

If extra length is necessary and an extension or handle will not work, you can specify extra plug length in 1" /25mm increments. NON-Relieved should only be specified for valve bores where obstructions like lands could make it difficult to remove the tool.

When possible specify the Dimensionair model number you are ordering the tooling for.

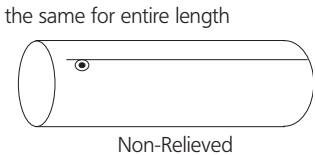
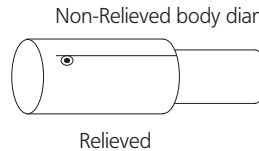
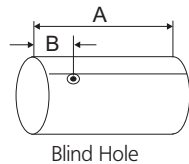
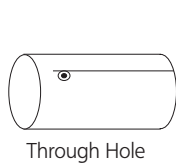

Non-Relieved body diameter means the same for entire length

Company \_\_\_\_\_ Contact: \_\_\_\_\_ Part Number: \_\_\_\_\_

Phone: \_\_\_\_\_ Fax: \_\_\_\_\_ Email: \_\_\_\_\_

**Required Information:**

Feature Size (shaft dia): \_\_\_\_\_

Size Tolerance: \_\_\_\_\_

Number of Jets\*: \_\_\_\_\_

Plug Style: Thru, Blind \_\_\_\_\_

Location Jets: \_\_\_\_\_

Extra Body length Req'd? \_\_\_\_\_

Extra length\* = \_\_\_\_\_

Quantity: \_\_\_\_\_

Overall Bore Length\*: \_\_\_\_\_

Dimensionair/Display to be used: \_\_\_\_\_

Part prints for other than non-standard plugs are required. \_\_\_\_\_

**Options for Air Plugs:**

Stop Collar: \_\_\_\_\_

OD Restrictions: \_\_\_\_\_

Special Plug Markings: \_\_\_\_\_

Extensions Required / length: \_\_\_\_\_

ISO Long Form Certification of Air Plug required? \_\_\_\_\_

Tooling Hose Required: \_\_\_\_\_

Handle Required: \_\_\_\_\_

Shut-off \_\_\_\_\_

Master required? \_\_\_\_\_

Nominal? \_\_\_\_\_

AMR Calibration kit required? \_\_\_\_\_

AFL-24 Oil/Water trap required? \_\_\_\_\_

*\* 2 jet check size, ovality, taper, bellmouth; 3 jet check 3 point out of round; 4 jet Average Diameter, requires special Dimensionair; 6 jet Average 2 point and 3 point out of round, requires special Dimensionair.*

Technical Assistance at Mahr Federal:  
 Phone: 401-784-3100  
 Fax: 401-784-3246 Email: information@mahr.com

**Dimensionair® Air Gages**

**Worksheet for Ordering Air Rings**

Special care **MUST** be taken when preparing proposals for Air Rings. There are five basic styles of Air Rings. Centered jets, offset jets, shoulder type, counter bored type, and snout type. Air rings may be attached directly to the Dimensionair, or used with base and guide chutes that can only be provided at time of manufacture. Mahr Federal strongly recommends a drawing (CAD preferred) accompany this inquiry.

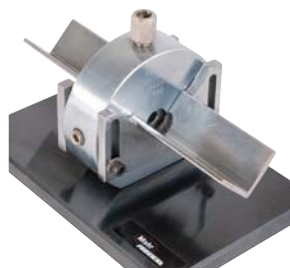

Company \_\_\_\_\_ Contact: \_\_\_\_\_ Part Number: \_\_\_\_\_  
 Phone: \_\_\_\_\_ Fax: \_\_\_\_\_ Email: \_\_\_\_\_

**Required Information:**

Feature Size mm/inch): \_\_\_\_\_  
 Size Tolerance: \_\_\_\_\_  
 Number of Jets\*: \_\_\_\_\_  
 Air Ring Style:  
 • Center jets  
 • Offset jets  
 • Shoulder style  
 • Counter bored  
 • Snout  
 \_\_\_\_\_  
 Overall length of diameter: \_\_\_\_\_  
 Quantity: \_\_\_\_\_  
 Dimensionair/Display to be used: \_\_\_\_\_  
 Part prints for other than non-standard plugs are required. \_\_\_\_\_

**Options for Air Plugs:**

OD Restrictions: \_\_\_\_\_  
 Special Plug Markings: \_\_\_\_\_  
 Base required: \_\_\_\_\_  
 Guide chutes required:  
 • Vee Style  
 • Tube Style  
 • Length of chute: 63mm/2.5" or 152mm/6"  
 \_\_\_\_\_  
 ISO Long Form Certification of Air Ring required? \_\_\_\_\_  
 Tooling Hose Required: \_\_\_\_\_  
 Shut-off \_\_\_\_\_  
 Master required? \_\_\_\_\_  
 Nominal? \_\_\_\_\_  
 AMR Calibration kit required? \_\_\_\_\_

Technical Assistance at Mahr Federal:  
 Phone: 401-784-3100  
 Fax: 401-784-3246 Email: information@mahr.com

### Dimensionair® Air Gages



*Air snaps combined with column gages for multiple diameters read easily at the point of manufacture.*



*Multiple jet plugs for average diameters, multiple diameters, taper and straightness.*



*Partial diameter air tooling for half bearing measurement*



*Air plug with multiple diameters and taper for automatic gage measurement of cylinder liners*



*Air tooling for I.D. and O.D. tapers — angle, size and side straightness*



*Squareness Fixture Gage*

