

To measure shafts between walls

M3 Star™ manual snap gauges are designed to measure outside diameters located between walls on shaft-like parts like crankshafts, transmission shafts and camshafts. They are easily re-tooled to measure different workpieces with the same gauge and are available in mechanical, wired and wireless configurations to meet a broad range of measurement needs.

M3 STAR

M3Star is an ergonomic, high-precision snap gauge that combines high technology and high quality in a compact body only 10mm wide. Two models are available to handle diameters from 5mm to 30mm and 30mm to 70 mm.

The advanced design is easily re-tooled using only one hex wrench to position both the contacts and V-block.

M3Star is supplied in the recommended configuration with the 20 mm thick "V" reference. 10mm and 14mm "V" references are also available for measurements in narrow spaces between shoulders.

The snap head can be combined with various handles and accessories.

MSG - ESG

- **M3Star MSG Mechanical Snap Gauge** is designed to be used with a dial or digital indicator in either a mini or standard holder.

The Snap Head is compatible with both the Marposs I-Wave wireless handle and pencil probe handle (8mm h6).

- The **M3 Star ESG Electronic Snap Gauge** is available in cable or wireless versions equipped with integrated HBT or LVDT transducers. The absence of friction in the measurement chain makes the M3 Star ESG exceptionally accurate.

TECHNICAL SPECIFICATIONS

	MSG	ESG
Thickness		10 mm
Thickness of the "V" part reference		20 mm
Measurable diameters and retooling range		5 - 15 mm
		15 - 30 mm
		30 - 50 mm
		50 - 70 mm
Working range		0,1 mm*
Clamping diameter for indicator/probe	Clamping diameter for indicator/probe: 8 mm h6	Cable length 3.5m with SV50/6 connector
Repeatability error (2,77 σ)	$\leq 1,5 \mu\text{m}$	$\leq 1 \mu\text{m}$

* By unscrewing the contacts fastened to the measuring armset by means of a screw with Heli-Coil, the measuring ranges can be extended up to 0,4 mm accepting lower performance.

M3 STAR - SNAP GAUGE

1 CONTACT PROTECTIONS: protect the contacts from accidental damage.

2 BODY: it is 10mm-thick designed to house and protect the measuring mechanism.

2.1 Mechanical measuring cells are housed in the M3Star MSG body and transfer the measurement to the dial indicator.

2.2 The electronic measuring cell with LVDT or HBT transducer is housed in M3Star ESG body and transfers the measurement to the display device.

3 MEASURING CONTACTS: The easily-replaced threaded tungsten carbide contacts facilitate rapid re-tooling. DLC covered or Diamond contacts are optionally available.

4 "V"-PART REFERENCE: Tungsten carbide planes in the support area reference the snap gauge to the workpiece cylindrical section to be measured. They are available in three versions with thicknesses of 20mm, 14mm or 10mm. A re-adjustment of the "V"-part with respect to the body allows the gauge center line to be changed to re-tool the gauge within the measuring range.

5 HANDLE: The ergonomically-designed handle is used to hold the snap gauge.

5.1 M3 Star MSG handle connects the Snap head to the dial indicator and is specifically designed for easy handling. it can be a Standard Indicator Holder (5.A) or a Mini Indicator Holder (5.B).

5.2 M3Star ESG is available with a standard handle with a 3,5m cable and SV/50 connector (5.C) or a Mini Wave handle (5.D).

6 NUMBER PLATE: Can be marked with any information required by the customer.

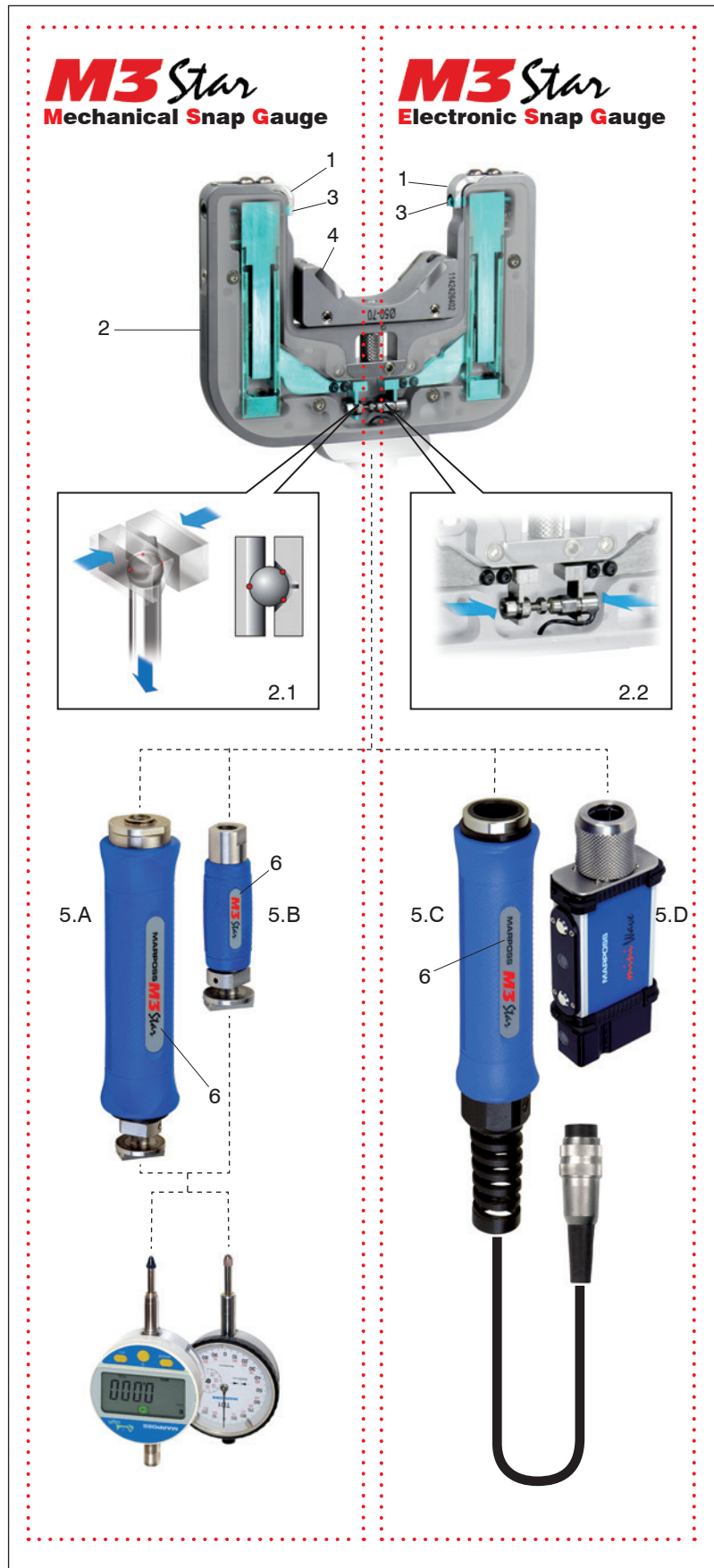





M3 Star Mechanical Snap Gauge

The complete snap gauge includes the measuring head, plus handle, chosen to suit the customer's application.



COMPLETE SNAP GAUGE

Complete M3 Star MSG Order Code



SNAP GAUGE	RANGE (mm)	 MINI INDICATOR HANDLE			 STANDARD INDICATOR HANDLE		
		20mm "V"	14mm "V"	10mm "V"	20mm "V"	14mm "V"	10mm "V"
			5 - 15	3TBAMISAWS	3TBAMITAWS	3TBAMIUAWS	3TBAIHSAWS
	15 - 30	3TBAMISBWS	3TBAMITBWS	3TBAMIUBWS	3TBAIHSBWS	3TBAIHTBWS	3TBAIHUBWS
	30 - 50	3TBAMISCWS	3TBAMITCWS	3TBAMIUCWS	3TBAIHCWS	3TBAIHTCWS	3TBAIHUCWS
	50 - 70	3TBAMISDWS	3TBAMITDWS	3TBAMIUDWS	3TBAIHSDWS	3TBAIHTDWS	3TBAIHUDWS

THE SNAP HEAD

M3 Star Mechanical Snap Head Order Code

SNAP GAUGE	RANGE (mm)	With 20mm "V" PART REFERENCE	With 14mm "V" PART REFERENCE	With 10mm "V" PART REFERENCE
	5 - 15	3TTASAWXXS	3TTATAWXXS	3TTAUAWXXS
	15 - 30	3TTASBWXXS	3TTATBWXXS	3TTAUBWXXS
	30 - 50	3TTASCWXXS	3TTATCWXXS	3TTAUCWXXS
	50 - 70	3TTASDWXXS	3TTATDWXXS	3TTAUDWXXS

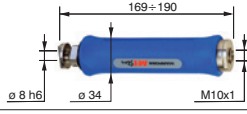
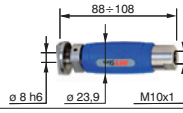
HANDLES

	DESCRIPTION	ORDER CODE
	Indicator handle	2TCLAS0030
	Mini Indicator handle	2TCSAS0030
	Protective shell for mechanical Indicator (P=38 mm)	2T0DIPS001
	Protective shell for digital Indicator (P=52 mm)	2T0DIPS000
	Protective dome for the upper lifting rod of Quick Digit Digit indicator	2T0DICS000

MSG DIMENSIONS

MSG Snap Head

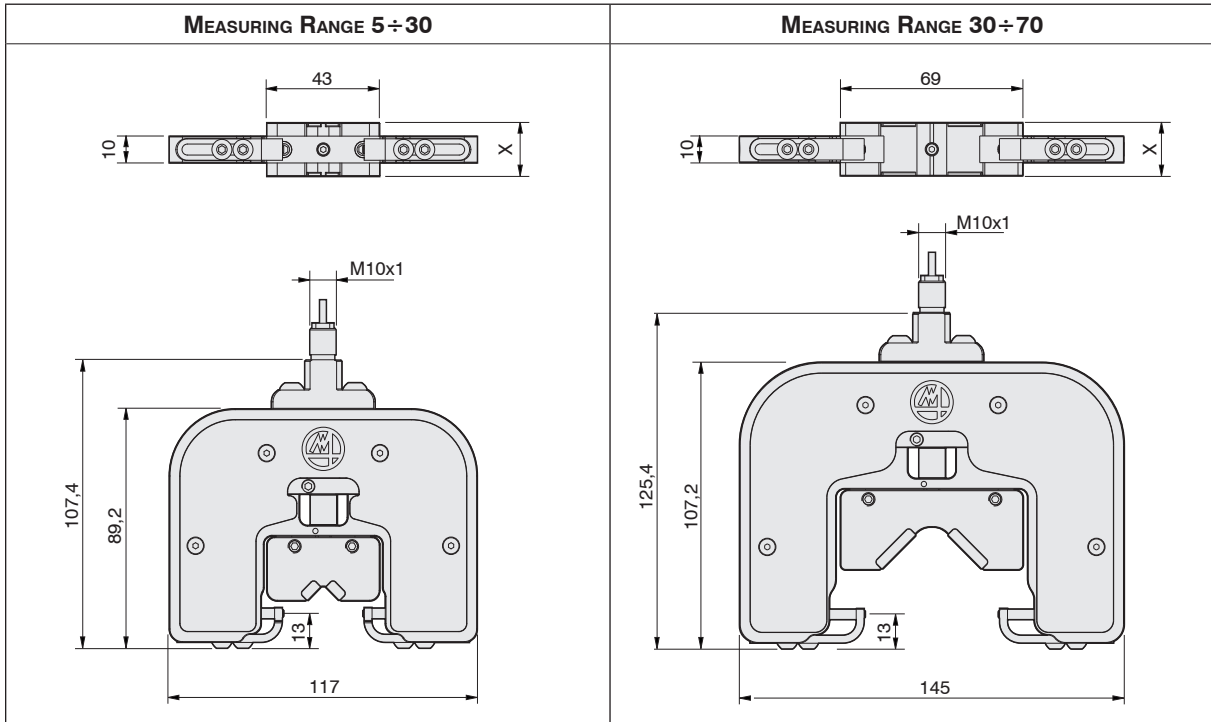

X = V REFERENCE PART THICKNESS	20mm	14mm	10mm
---------------------------------------	-------------	-------------	-------------

Complete snap gauge

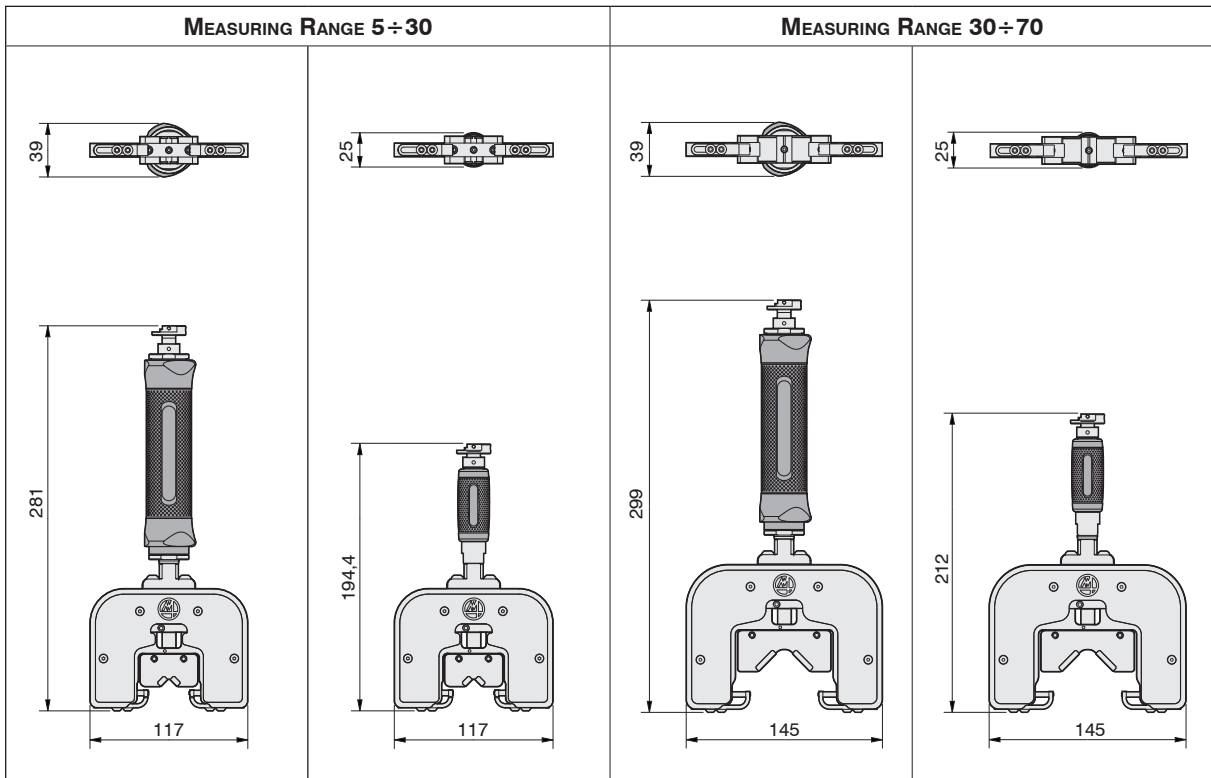





M3 Star Electronic Snap Gauge





The complete snap gauge includes the measuring head, plus handle, chosen to suit the customer's application.

COMPLETE SNAP GAUGE

Complete M3 Star ESG LVDT Order Code



SNAP GAUGE	RANGE (mm)	 STANDARD HANDLE WITH 3,5M CABLE			 MINI WAVE HANDLE		
		20mm "V"	14mm "V"	10mm "V"	20mm "V"	14mm "V"	10mm "V"
			5 - 15	3TBE3SAWS	3TBE3TAWS	3TBE3UAWS	3TBEWSAWS
15 - 30	3TBE3SBWS		3TBE3TBWS	3TBE3UBWS	3TBEWSBWS	3TBEWTBWS	3TBEWUBWS
	30 - 50	3TBE3SCWS	3TBE3TCWS	3TBE3UCWS	3TBEWSCWS	3TBEWTCWS	3TBEWUCWS
	50 - 70	3TBE3SDWS	3TBE3TDWS	3TBE3UDWS	3TBEWSDWS	3TBEWTDWS	3TBEWUDWS

Complete M3 Star ESG HBT Order Code

SNAP GAUGE	RANGE (mm)	 STANDARD HANDLE WITH 3,5M CABLE			 MINI WAVE HANDLE		
		20mm "V"	14mm "V"	10mm "V"	20mm "V"	14mm "V"	10mm "V"
			5 - 15	3TBHE3SAWS	3TBHE3TAWS	3TBHE3UAWS	3TBHEWSAWS
15 - 30	3TBHE3SBWS		3TBHE3TBWS	3TBHE3UBWS	3TBHEWSBWS	3TBHEWTBWS	3TBHEWUBWS
	30 - 50	3TBHE3SCWS	3TBHE3TCWS	3TBHE3UCWS	3TBHEWSCWS	3TBHEWTCWS	3TBHEWUCWS
	50 - 70	3TBHE3SDWS	3TBHE3TDWS	3TBHE3UDWS	3TBHEWSDWS	3TBHEWTDWS	3TBHEWUDWS

THE SNAP HEAD

M3 Star Electronic Snap Head Order Code

SNAP GAUGE	RANGE (mm)	LVDT TRANSDUCER			HBT TRANSDUCER		
		WITH 20mm "V" PART REFERENCE	WITH 14mm "V" PART REFERENCE	WITH 10mm "V" PART REFERENCE	WITH 20mm "V" PART REFERENCE	WITH 14mm "V" PART REFERENCE	WITH 10mm "V" PART REFERENCE
			5 - 15	3TTFSAXXS	3TTFTAWXS	3TTFUAWXS	3TTHTSAWXS
15 - 30	3TTFSBWXS		3TTFTBWXS	3TTFUBWXS	3TTHTSBWXS	3TTHTBWXS	3TTHTUBWXS
	30 - 50	3TTFSCWXS	3TTFTCWXS	3TTFUCWXS	3TTHTSCWXS	3TTHTCWXS	3TTHTUCWXS
	50 - 70	3TTFSDWXS	3TTFTDWXS	3TTFUDWXS	3TTHTSDWXS	3TTHTDWXS	3TTHTUDWXS

ESG DIMENSIONS

ESG Snap Head

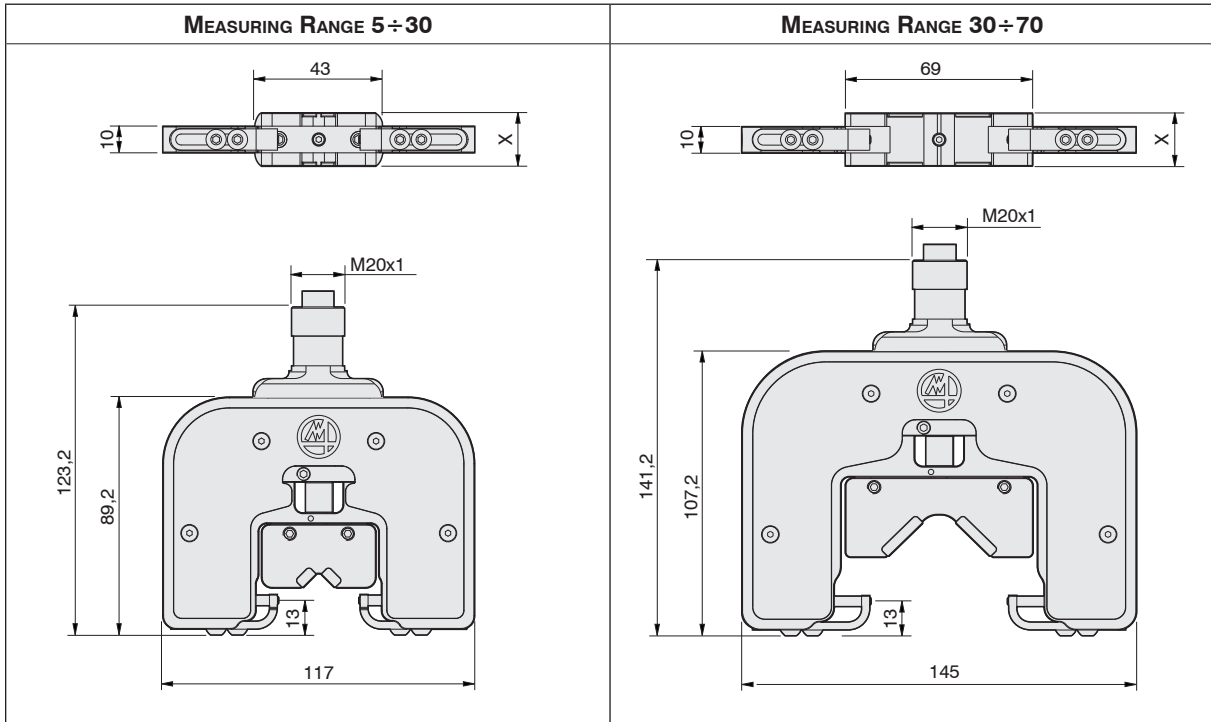

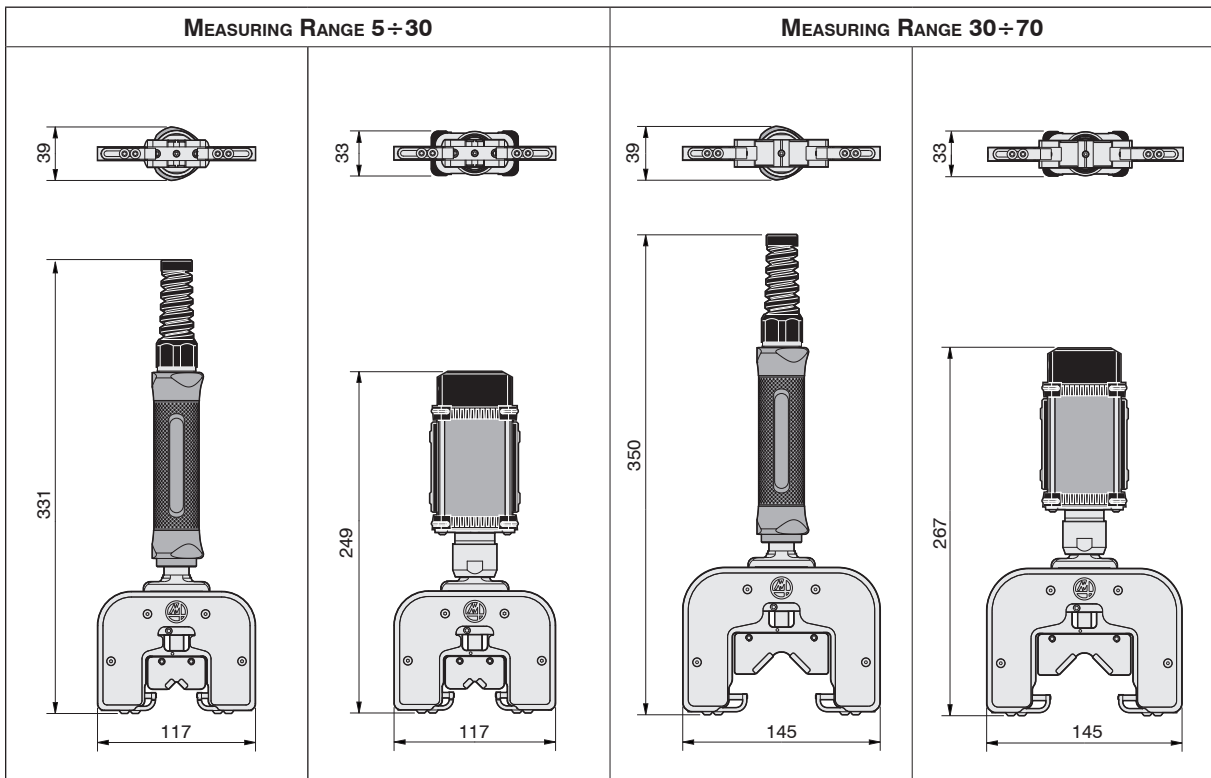

X = V REFERENCE PART THICKNESS	20mm	14mm	10mm
---------------------------------------	-------------	-------------	-------------

Complete snap gauge







HANDLES

HANDLES AND CABLES FOR ESG SNAP GAUGE



	DESCRIPTION	ORDER CODE
	Mini Wave Handle for wireless transmission	Available on request
	M3Star handle (without cable)	2TH3000001
	Cable 2 mt LVDT - connector SV50/6	2TG0000026
	Cable 3,5 mt LVDT - connector SV50/6	2TG0000356
	Cable 5 mt LVDT - connector SV50/6	2TG0000056
	Cable 2 mt LVDT - connector S3	2TG0000023
	Cable 2 mt TESA COMPATIBLE - connector SV50/6	2TG00TS026
	Cable 2 mt HBT - connector SV50/6	2TG0001026
	Cable 3,5 mt HBT - connector SV50/6	2TG0001356
	Cable 5 mt HBT - connector SV50/6	2TG0001056

SPARES AND ACCESSORIES



BODIES (V part, contacts and contact protections not included)

	M3 STAR MSG		M3 STAR ESG		
				LVDT	HBT
5-30mm		2942426421		2942426422	2942426423
30-70mm		2942426411		2942426412	2942426413

V-PART REFERENCES

RANGE	20mm "V"	ORDER CODE	14mm "V"	ORDER CODE	10mm "V"	ORDER CODE
5 - 15 mm		2942426459		2942426463		2942426457
15 - 30 mm		2942426458		2942426462		2942426456
30 - 50 mm		2942426455		2942426465		2942426453
50 - 70 mm		2942426454		2942426464		2942426452







COMPONENTS

CONTACT (CARBIDE 1 PIECE)		CONTACT PROTECTIONS (CARBIDE)	
DESCRIPTION	ORDER CODE	DESCRIPTION	ORDER CODE
	3TXCX00026		M3Star 5÷30 mm 2942426434
			M3Star 30÷50 mm 2942426435
			M3Star 50÷70 mm 2942426436

TOOLS

DESCRIPTION	ORDER CODE
	4413675303
2,5 mm Hex wrench	4413675304

SPARES

DESCRIPTION	ORDER CODE
	2042426432
	2042426406
	Spring – 1 piece 1042426287
	Screw for spring limitation - 1 piece 1042426286
	Transfer Rod 2042433015
	Rod Bushing 1042433204

DEPTH EXTENSIONS available only for M3star MSG

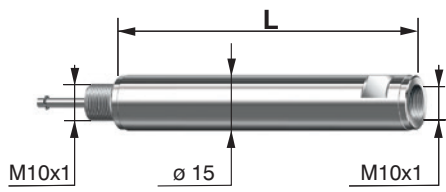
Length L (mm)	ORDER CODE
	50 2TXMSF0050
65	2TXMSF0065
80	2TXMSF0080
100	2TXMSF0100
125	2TXMSF0125

STAND available only for M3star ESG Mini Wave

DESCRIPTION	ORDER CODE
	Stand charger for M3 Star ESG with Mini Wave handle (power supply unit included). Available on request

For a full list of address locations, please consult the Marposs official website

D6M3ST02G0 - Edition 07/2018 - Specifications are subject to modifications © Copyright 2018 MARPOSS S.p.A. (Italy) - All rights reserved.

MARPOSS, logo and Marposs product names/signs mentioned or shown herein are registered trademarks or trademarks of Marposs in the United States and other countries. The rights, if any, of third parties on trademarks or registered trademarks mentioned in the present publication are acknowledged to the respective owners.

Marposs has an integrated system to manage the Company quality, the environment and safety, attested by ISO 9001, ISO 14001 and OHSAS 18001 certifications.

Some models of the product line, or parts of them, may be subject to export restrictions if exported outside the European Union or may be subject to restrictive measures adopted by the competent national, supranational or international authorities.