

Thank you for your selection of the HT-4200 Handheld Digital Tachometer.

To ensure the performance of the HT-4200, please read this manual thoroughly.

Warnings and Cautions

In this document precautions are classified into two categories: WARNING and CAUTION. This depends on the degree of danger or damage possible if the precaution is ignored and the product is used incorrectly.

	WARNING This symbol is used to indicate precautions where there is a risk of death or serious personal injury to the operator if the product is handled incorrectly.
	CAUTION This symbol is used to indicate precautions where there is a risk of some personal injury to the operator or only material damage to the product if the product is handled incorrectly.

Copyright © ONO SOKKI CO., LTD. 2012 All rights reserved.

Omission of Issuance of Certificate

This product has been tested under strict inspections for correct operation before shipment. Please note that the issuance of certificate is omitted.

Warranty

- This product is covered by a warranty for a period of one year from the date of delivery.
- This warranty covers free-of-charge repair during the warranty period for defects occurred while the product is used under correct operating conditions according to descriptions in this manual and notices on the unit label.
- For free-of-charge repair during the warranty period, contact your dealer or your nearest Ono Sokki sales office nearby.
- Even during the warranty period, the following failures will be handled on a fee basis.
 - Failures or damages occurring through misuse, misoperation, repairing without ONO SOKKI'S approval.
 - Failures or damages occurring through mishandling (dropping) during transportation after purchase.
 - Failures or damages occurring by an Act of God (fires, earthquakes, flooding, and lightning), environmental disruption, or abnormal voltage.
 - Replenishment of expendable supplies, spare parts, and accessories.

This guarantee covers only the performance of the product itself only.

All inconvenience by the trouble of this product is not included.

*Outer appearance and specifications are subject to change without prior notice.

HOME PAGE: <http://www.onosokki.co.jp/English/english.htm>

WORLDWIDE

ONO SOKKI CO., LTD.
1-16-1 Hakusan, Midori-ku,
Yokohama 226-8507, Japan
Phone : +81-45-935-3918
Fax : +81-45-930-1808
E-mail : overseas@onosokki.co.jp

Observe the Following Points before Use

General Precautions

- **Be sure to read this instruction manual.**

To take advantage of the excellent performance of this product and use it safely, be sure to thoroughly read this instruction manual.

- **Avoid rapid temperature change.**

Do not move the product rapidly from a hot place to a cold one or vice versa. Condensation can form inside the unit which may cause failure.

- **Be careful not to get water, dust, or foreign materials inside the unit.**

Do not use the product in places where you may get water or oil or places which are humid or dusty.

- **Do not drop the product or apply excessive shock to it.**

Since this product incorporates high-precision electronic parts, be careful not to drop it or apply strong shock.

- **Do not damage the lens of the light projector-receiver.**

Damaged lens may degrade the performance.

- **Wipe dirt off using a dry cloth or a cloth dampened with neutral detergent and squeezed firmly.**

Do not use volatile oils (thinner or benzene) or alcohols.

- **If you do not use the product for a prolonged period of time, be sure to remove the batteries.**

Leaving it unused for a prolonged period of time or exhausted batteries may cause battery leakage.

WARNING

- **PBe careful not to touch the body of revolution.**

Overview

1. Overview

This product is a contactless handheld tachometer with builtin batteries integrating the rotary detector, measurement unit, and display.

It makes it possible to measure rotational speed simply by sticking reflective marks on the body of revolution and applying visible light from the rotary detector to the body of revolution.

2. Features

- Compact lightweight body and large LCD.
- Can measure from 30 r/min to 50,000 r/min in steps of 1 r/min (with one reflective mark).
- Multiple reflective marks can be used, enabling measurement from rotational speed of as lower as 4 r/min.
- Memory function (with up to 10 memory numbers) which is useful for checking measurement results.
- Over-range display function which fixes the display value to the maximum value and displays "ERROR" if a measurement value exceeds each measurement range.
- Retains the display of the final measurement value for about 30 seconds after completion of measurement.

3. Unpacking

When you unpack the unit, make sure that you have all the following:

- ① HT-4200 main unit x1
- ② Reflective mark x1 sheet (25 marks)
- ③ Type AAA alkaline battery x3
- ④ Instruction manual x1

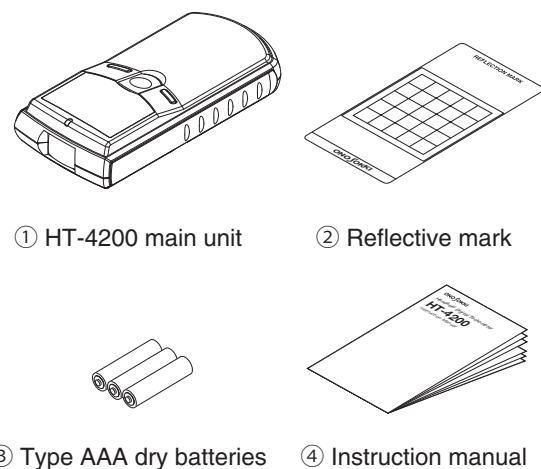

Note: Since the supplied batteries are samples, some may be exhausted quickly.

Option

- ① HT-011 : Reflective mark x1 set (10 sheets) (12 mm x 12 mm x 250 marks)
- ② HT-0400 : Carrying case
- ③ HT-0003 : Soft case

Storage

The storage temperature range of the HT-4200 is -10 °C to +55 °C. When you store it, avoid locations where the temperature is extremely high or low or the humidity is high. Store it in a place which is well-ventilated and not exposed to direct sunlight.

If you do not use it for a prolonged period of time, be sure to remove the batteries to prevent accident caused by battery leakage, etc.

Name and Function of Each Section

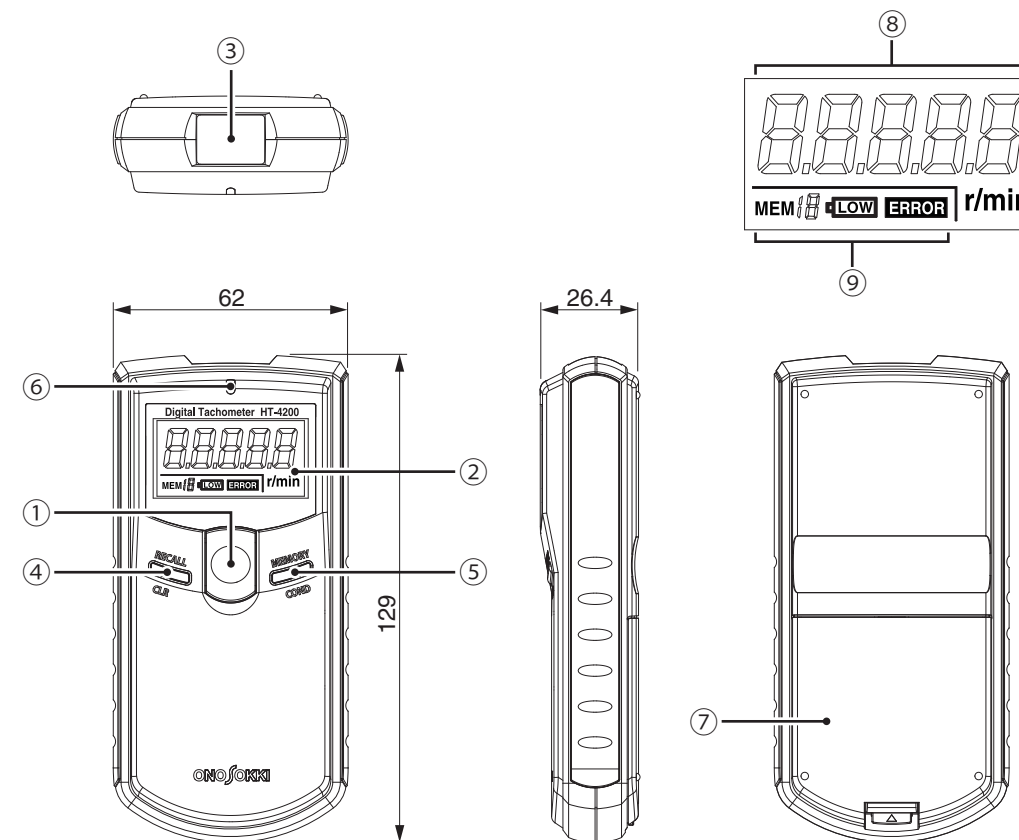

① Power switch

Turns the power ON or OFF. Even if you release the power switch, the power ON condition is retained for 30 seconds.

② Display

Displays measurement values and various conditions.

③ Rotary detector

Light projector-receiver for detecting reflective light (rotational signal), which incorporates a red light-emitting diode (LED) and a light-sensitive element.

④ RECALL/CLR switch

Recalls memorized measurement values and clears them at one time.

⑤ MEMORY/COND switch

Writes data in memory at the time of measurement, selects the setup mode, and changes settings.

⑥ Indicator (input signal indicator)

When the rotary detector detects reflected light, the LED indicator lights up.

⑦ Battery cover

Remove this cover to replace the batteries. Use three Type AAA dry batteries.

⑧ MAIN display

Displays measurement values and settings.

⑨ SUB display

Indicates the memory address (memory number), LOW battery, and error.

Power Supply

The HT-4200 operates on three Type AAA batteries.

If the batteries are exhausted and the LOW mark "LOW" appears, replace them with new ones. Be sure to replace all the three batteries at the same time.



Battery replacement procedure

- ① While pushing lightly the Δ mark at the rear end of the battery cover with your finger, raise it to remove.
- ② Put batteries properly in the battery compartment with the correct polarity (+/-).
- ③ Close the battery cover.

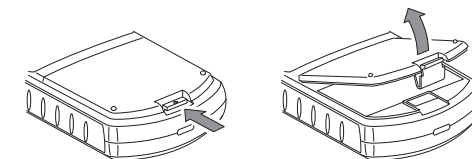

Operations

1. Measurement

■ Normal Measurement

- Stick one reflective mark on the body of revolution under measurement. (For details on the procedures for sticking a reflective mark, refer to the following section 2, "Notes on Measurement.")
- Wipe off oil, water, dust, and other dirt from the surface on which a reflective mark is to be stuck, then stick a reflective mark so that there be no unevenness.
- If the target surface is shiny with plating or the like, apply light aslant to the reflecting surface or paint the surface black before sticking a reflective mark.
- Turn ON the power switch and apply light from the light projector to the reflective mark position. Then, make sure that the indicator lights up (seems to lights up continuously with high-speed revolution).
- To obtain correct data, continue each measurement for at least 3 seconds.
- Keep an appropriate distance between the rotary detector and the reflecting surface. (For measurement distance, refer to "Is the distance appropriate?" in Troubleshooting.)

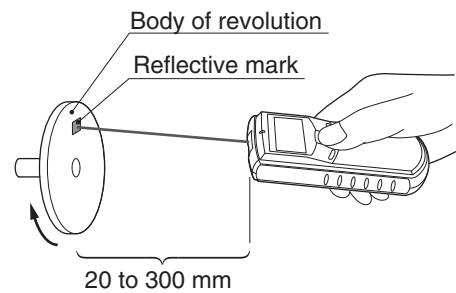

- If you press and hold the power switch, the rotational speed is displayed in digital form at 1-second intervals.
- When you release the power switch, the display of the last measurement value is retained for about 30 seconds and then automatically turns off.

■ Measurement of Low-speed Revolution

- Sticking multiple reflective marks enables measurement from a low rotational speed. (For details on the procedures for sticking reflective marks, refer to the following section 2, "Notes on Measurement.")

Measurement Range	Number of Reflective Marks	Setting
30 to 50,000 r/min	1	P 1
15 to 25,000 r/min	2	P 2
10 to 16,667 r/min	3	P 3
8 to 12,500 r/min	4	P 4
5 to 8,333 r/min	6	P 6
4 to 6,250 r/min	8	P 8

- Press and hold the MEMORY/COND switch for at least 2 seconds, the setup mode for the number of reflective marks is entered. The current setting of the number of marks is displayed in the MAIN display. In this mode, each time you press the MEMORY/COND switch, the number of marks is incremented. Set the number of reflective marks which were stuck in Step ①.

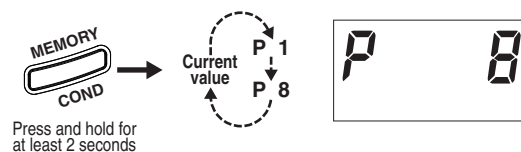

- Press the power switch to return to the measurement mode. The current display value is applied. If you perform no operation for 30 seconds in the setup mode, the display value immediately before turning OFF the power is applied.

2. Notes on Measurement

(1) Measurement distance

The specified maximum measurement distance of 30 cm is a measurement distance when a 12 mm x 12 mm reflective mark is used on a flat surface and light is applied perpendicularly to the reflective mark.

The measurement distance becomes short in the following cases:

- When a reflective mark is stuck on a curved surface Example: When a reflective mark is stuck on a shaft
- When a reflective mark is cut
- When light is applied aslant

(2) Applying light to reflective marks

This product detects revolution based on the presence or absence of reflected light. Therefore, if light is constantly applied to the reflective mark, revolution cannot be detected. Apply the red light from the light projector to the reflective mark so that there be a timing when it is applied to the mark and a timing when it is not during one revolution of the body of revolution. Note this point in particular when a reflective mark is stuck near the center axis of revolution.

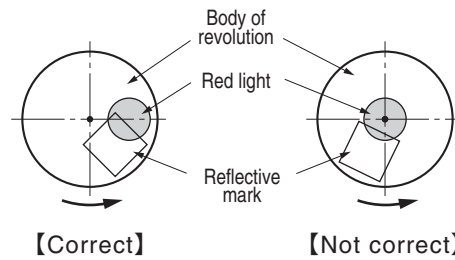

(3) Sticking reflective marks in high-speed revolution measurement

To detect a rotational signal, it is necessary for the HT-4200 to receive the reflected light from the reflective mark for at least about 0.2 ms. Depending on the position of the reflective mark, the time during which the HT-4200 receives light may become shorter than 0.2 ms in high-speed revolution, disabling measurement. Be careful of the position of the reflective mark.

(4) When a reflective mark peels off in high-speed revolution

If a reflective mark peels off in high-speed revolution such as 10,000 r/min, use another adhesive agent together.

(5) If a reflective mark cannot be stuck

If a reflective mark cannot be stuck on the body of revolution for a certain reason, make a portion which reflects light and a portion which does not on the body of revolution. In this case, note that measurable distance and angle largely differs from those when a reflective mark is stuck.

3. Measurement Value Memory Function

(1) Memorizing measurement values

- To memorize the current measurement value, press the MEMORY/COND switch in the measurement mode.
- When a measurement value has been memorized, the memory number in the SUB display is incremented.
- Up to 10 measurement values can be memorized. If you press the MEMORY/COND switch after memorizing 10 values, "FULL" is displayed in the MAIN display for about one second indicating that no more values cannot be memorized.



(2) Applying light to reflective marks

- Memorized values can be recalled by pressing the RECALL/CLR switch in the measurement mode. The SUB display displays the memory number like "MEM XX" (example: MEM 5).
- The value memorized last is recalled first, then, in order of the memory number: MEM 1, MEM 2, MEM 3, ... MEM 10.
- When three values have been memorized, for example, the value memorized in MEM 3 is displayed first and the SUB display indicates MEM 4. The MAIN display displays "-----" indicating that there is no more memorized values. Therefore, if there is no memorized value in memory, "-----" is displayed for MEM 1.

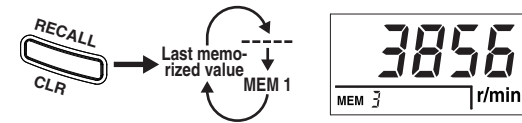

- To return to the measurement mode from the RECALL mode, press the power switch or leave the HT-4200 without making any switch operation for 30 seconds to turn OFF the power.

(3) Clearing (all) memorized values

- To clear the memory contents, press the RECALL/CLR switch for at least 2 seconds. When the memory has been cleared, "CLR" is displayed in the MAIN display for about one second.

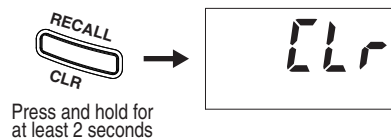

4. SUB Display

■ ERROR Display

If a measurement value exceeds each measurement range, the MAIN display value is fixed to the maximum value and the ERROR mark "ERROR" appears in the SUB display.

When there is only one reflective mark, the measurable range of rotational speed for the HT-4200 is exceeded.

When there are two or more reflective marks, adjust the number of reflective mark so that the ERROR mark "ERROR" is not displayed during measurement.

The maximum rotational speed which can be measured by the HT-4200 is 50,000 r/min.

■ LOW Battery Display

If the LOW mark "LOW" lights up, it indicates that the dry batteries have been exhausted.

- This mark lights up if the battery voltage drops to 3.3 V or lower.
- If the mark lights up, immediately replace the three dry batteries with new ones. Using the exhausted batteries may disable measurement.

Specifications

1. Measurement Section

Operation method : Periodic operation method
Measurement unit : 1 r/min
Measurement range :

Measurement Range	Number of Reflective Marks
30 to 50,000 r/min	1
15 to 25,000 r/min	2
10 to 16,667 r/min	3
8 to 12,500 r/min	4
5 to 8,333 r/min	6
4 to 6,250 r/min	8

Measurement accuracy : 30 to 12,499 r/min ± 1 r/min
12,500 to 24,999 r/min ± 2 r/min
25,000 to 50,000 r/min ± 4 r/min
(With one reflective mark)

Over-range display : If a measurement value exceeds each measurement range, the MAIN display value is fixed to the maximum value and the ERROR mark "ERROR" appears in the SUB display.

2. Rotary Detector

Detecting method : Visible light photoelectric reflection method
Detection distance : 20 to 300 mm
Light source : Red light-emitting diode (LED)
Light receiver : Phototransistor
Detection mark : Number of reflective marks per revolution
Can be changed to 1, 2, 3, 4, 6, or 8 with a COND switch.

3. Display

Number of display digits: 5 digits
Character height : 10.5 mm
Indicator : 7-segment LCD
Refresh time : 1 second (or 2 seconds when the rotational speed is equal to or less than 60 divided by the number of reflective marks (r/min))

4. Measurement Mode

Data hold function : When measurement is completed, the display of the last measurement value is retained for about 30 seconds and then automatically turns off (auto power off).

Memory function : A measurement value is stored in memory each time the MEMORY/COND switch is pressed. Up to 10 measurement values can be memorized. Since these values are stored in non-volatile memory, they are retained even after you turn OFF the power.

5. General Specifications

Power supply : Type AAA dry battery (x3)
Continuous operating time : About 20 hours (with alkali dry batteries at 20 °C)
Battery LOW display : When the battery voltage drops to 3.3 V or lower, the LOW mark "LOW" lights up.
Operating temperature range : 0 °C to +40 °C
Storage temperature range : -10 °C to +55 °C
Operating humidity range : 35 to 85%RH (without condensation)
Storage humidity range : 35 to 85%RH (without condensation)
Mass : About 90 g (dry batteries not included)
Dimensions : 129 x 62 x 26.4 mm

6. Applicable Standards

■ CE Marking
EMC Directive (2004/108/EC)

Troubleshooting

If you perceive any abnormal condition, first check the following points. If the instrument does not operate normally after check, contact your dealer (Ono Sokki agency) or Ono Sokki sales office nearby.

Symptom	Check Point	Countermeasure
● No display	① Are batteries set ? ② Is the battery polarity correct ? ③ Are batteries exhausted ? ④ Does the display recover after replacing the batteries ?	① Set batteries. ② Change the battery polarity correctly. ③ Replace all batteries with new ones. ④ Perform the reset operation. 1. Remove the batteries. 2. Press and hold the power switch for several seconds. 3. Set the batteries.
● The display value differs from the actual value.	① Is the number of reflective marks stuck on the body of revolution set in the HT-4200 ? ② Does the surface of the body of revolution diffusely reflect light because of damage or irregularity ?	① Although low rotational speeds can be measured by sticking some reflective marks, it is necessary to set the number of marks in the HT-4200. Set the number of marks correctly. ② Prevent diffuse reflection by cleaning the surface of the body of revolution, applying light aslant to a reflective mark, and painting the reflecting surface black.
● The display is normal but measurement cannot be performed.	① Is a reflective mark stuck on the body of revolution ? ② Is the distance appropriate ?	① Stick necessary number of reflective marks according to the number of revolutions to the body of revolution. ② Use the HT-4200 within a measurable distance of 20 to 300 mm.