

GLASTONBURY SOUTHERN GAGE™

1955

"HELPING COMPANIES MEASURE THEIR SUCCESS"

PRICE BOOK

2021



Over 4,000 Thread Items
in Stock



SEPTEMBER 2021

Need it fast? **Redline**
Service available...
For the latest in GSG
Products see our on-line
catalog!



www.gsgage.com



GSG...YOUR SOURCE FOR SPECIAL GAGES

MOBILE FRIENDLY, JUST SCAN THE CODES ON THE PAGES FOR
ADDITIONAL PRODUCT INFO



TABLE OF CONTENTS

Products	Price List Page #
Certifications of New Product Calibration Service	3
Thread Work Plugs	
Taperlock Style	
Steel	4-5
Chrome	6-7
Reversible Style	
Steel	8
Chrome	9
Thread Rings	
True Round (Southern Style)	10-11
AGD Style	12-13
Thread Set Plug Gages	14-15
Tapered Pipe Thread Gages	16-17
Helical Coil (STI) Thread Work Plugs	18
Hole Location Plugs (Flex Plugs)	19
Snap Gages	20
Cylindrical Gages/Masters	
Ring Gages	21-22
Master Discs	23-24
Reversibles	25-27
Taperlocks/Trilocks	28-30
Progressives	30
Cylindrical Taper Gages	31
Cylindrical Taper Gage RFQ Form	32
Surveillance Masters	
Micrometer Set Masters	33
Vernier Caliper Masters	33
Depth Micrometer Masters	34
QUIKCHEK Masters	34
Geometric Chek Master	34
Z-Axis Chek Masters	34
Variable Thread Gaging Systems	
For External Product	
Full Form Master Set Plugs	35-36
TRI-ROLL Systems	35-37
STC Segment Systems	38
For Internal Product	
ITC Segment Systems	38-39
Master Setting Rings	39
Zero Spindle System	40
Digital Chamfer Gages	41-42
Chamfer Ring Masters	43
Medical Gages	44
Digital Indicators	45
Mechanical Indicators	46
Indicator Accessories	47
Hex / Square Plugs	48
Decimal Chart	49

INDEX

Alphabetical Listing of Products	Price List Page #
BSP Gages	17
Certification of New Product	3
Certifications Service	3
Chamfer Gages	41-42
Chamfer Ring Masters	43
Cylindrical Gages/Masters	21-30
Cylindrical Taper Gages	31
Depth Micrometer Masters	34
Flex Plugs (Hole Location Gages)	19
Full Form Set Plugs	35-36
Geometric Chek Master	34
Helical (STI) Thread Work Plugs	18
Hexalobe Gages	44
Hex Gages	48
Hole Location Plugs (Flex Plugs)	19
Indicators (Digital)	45
Indicators (Mechanical)	46
Indicator Accessories	47
ITC Segment Systems	38-39
Master Discs	23-24
Medical Gages	44
Micrometer Set Masters	33
Progressives	30
QUIKCHEK Masters	34
Reversibles, Cylindrical	25-27
Ring Gages, Cylindrical	21-22
Solid Master Thread Set Rings	39
Snap Gages	20
STC Segment Systems	38
Surveillance Masters	33-34
Tapered Pipe Thread Gages	16-17
Taper Gages, Cylindrical	31
Taperlocks/Trilocks, Cylindrical	28-30
Thread Rings, AGD Style	12-13
Thread Rings, True Round (Southern Style)	10-11
Thread Set Plug Gages, truncated	14-15
Thread Work Plugs	4-9
TRI-ROLL Systems	35-37
Variable Thread Gaging Systems	35-39
Vernier Caliper Masters	33
Wire Style, Cylindrical Reversible	25-27
Z-Axis Chek Masters	34
Zero Spindle System	40

Prices subject to change based on market fluctuations for material cost. Please check our on-line catalog for the latest up-to-date pricing & new product releases at www.gsgage.com

Unless otherwise specified, GSG gages will be supplied with the following standard practices.

Edges broken with Radius or chamfers of .005" to .020" (0.13mm to 0.51mm). Special markings: Go/Nogo sizes, class and tool number are permanently marked at no extra charge. Additional markings are \$.25 per character.

Warranty: Glastonbury Southern Gage warrants all gages for 30 days from date of shipment except in cases of obvious customer abuse and mishandling. GSG offers no further warranties, expressed or implied and its responsibilities due to any defects of inaccuracies in any gage or certificate shall, in no event nor for any cause whatsoever exceed the purchase price.

MINIMUM ORDER VALUE \$75.00



MOBILE FRIENDLY, JUST SCAN THE CODES ON THE PAGES



CERTIFICATIONS

ACCREDITED CERTIFICATION
STANDARD LONG FORM CERTIFICATION
CUSTOMER'S PROPERTY CALIBRATION



ADDITIONAL COPIES OF CERTS (EMAILED OR PRINTED) WILL BE \$5.00 EACH

CERTIFICATION for NEW PRODUCT			GAGE INSPECTION SERVICE - CUSTOMER PROPERTY All Customer Property A2LA Certified		
	A2LA Price	Standard Price		A2LA Price	
Thread Work Plug Gages			Thread Work Plug Gages		
#0 to 1.5" Taperlock	\$ 33.00	\$ 20.00	#0 to 1.5" Taperlock	\$ 61.00	
1.5001" to 5" Trilock	\$ 39.00	\$ 20.00	1.5001" to 5" Trilock	\$ 74.00	
5.001" to 8" Trilock	\$ 43.00	\$ 24.00	5.001" to 8" Trilock	\$ 85.00	
8.001" and above Trilock	\$ 49.00	\$ 30.00	8.001" and above Trilock	\$ 102.00	
Thread Ring Gages			Thread Ring Gages (With Set Plugs available)		
Standard Size #0 to #5	\$ 51.00	\$ 20.00	Standard Size #0 to #5	\$ 91.00	
Standard Size #6 to 1.5"	\$ 47.00	\$ 20.00	Standard Size #6 to 1.5"	\$ 74.00	
Non - Standard Sizes #0 to 5"	\$ 47.00	\$ 20.00	Non - Standard Sizes #0 to 5"	\$ 91.00	
Non - Standard Sizes 5.001" - 8"	\$ 67.00	\$ 24.00	Non - Standard Sizes 5.001" - 8"	\$ 137.00	
Non - Standard Sizes Above 8"	\$ 73.00	\$ 30.00	Non - Standard Sizes Above 8"	\$ 164.00	
Thread Set Plugs Gages			Thread Set Plugs Gages		
#0 to 1.5" Taperlock	\$ 33.00	\$ 20.00	#0 to 1.5" Taperlock	\$ 65.00	
1.5001" to 5" Trilock	\$ 39.00	\$ 20.00	1.5001" to 5" Trilock	\$ 80.00	
5.001" to 8" Trilock	\$ 43.00	\$ 24.00	5.001" to 8" Trilock	\$ 94.00	
8.001" and above Trilock	\$ 49.00	\$ 30.00	8.001" and above Trilock	\$ 113.00	
Tapered Pipe Gages Plugs (NPT, ANPT, NPTF)			Tapered Pipe Gages Plugs (NPT, ANPT, NPTF)		
1/16 to 3"	\$ 55.00	\$ 35.00	1/16 to 3"	\$ 79.00	
3.5" to 6"	\$ 55.00	\$ 35.00	3.5" to 6"	\$ 81.00	
8" and above	\$ 61.00	\$ 41.00	8" and above	\$ 115.00	
Tapered Pipe Gages Rings (NPT, ANPT, NPTF)			Tapered Pipe Gages Rings (NPT, ANPT, NPTF)		
1/16 to 3"	\$ 63.00	\$ 43.00	1/16 to 3"	\$ 87.00	
3.5" to 6"	\$ 63.00	\$ 43.00	3.5" to 6"	\$ 89.00	
8" and above	\$ 69.00	\$ 49.00	8" and above	\$ 123.00	
Cylindrical Rings, Master Discs & Plug Gages			Cylindrical Rings, Master Discs & Plug Gages		
*.015 to .03999 Rings	*	\$ 198.00	*.015 to .03999 Rings	\$ 198.00	
.015 to .03999 Plugs	\$ 49.00	\$ 22.00	.015 to .03999 Plugs	\$ 90.00	
.040 to .365	\$ 35.00	\$ 22.00	.040 to .365	\$ 90.00	
.366 to 2.500	\$ 33.00	\$ 20.00	.366 to 2.500	\$ 90.00	
2.501 to 5.510	\$ 47.00	\$ 37.00	2.501 to 5.510	\$ 94.00	
5.511 to 11.000	\$ 70.00	\$ 60.00	5.511 to 11.000	\$ 110.00	
11.001 to 15.000	\$ 90.00	\$ 70.00	11.001 to 15.000	\$ 143.00	
15.001 to 22.000	\$ 155.00	\$ 95.00	15.001 to 22.000	\$ 237.00	
22.001 and up Call Factory			* 22.001 and up Call Factory		
Roundness Charts			* Roundness Charts		
First Trace	N/A	\$ 100.00	First Trace	\$ 100.00	
Each Additional Trace	N/A	\$ 75.00	Each Additional Trace	\$ 75.00	
Cylindrical Taper Gages			Cylindrical Taper Gages		
Standard Tapers, Tapers with Specs	N/A	\$ 60.00	* Standard Tapers, Tapers with Specs	\$ 120.00	
			* Special Tapers without B/P or Specs (Subject to size consideration)	\$ 170.00	
Snap Gages	N/A	\$ 65.00	Snap Gages	\$ 75.00	
Variable Tri-Rolls	N/A	\$ 55.00	Variable Tri-Rolls	\$ 75.00	
Surveillance Masters			Surveillance Masters		
01-1 English or Metric	\$ 125.00	\$ 90.00	01-1 English or Metric	\$ 165.00	
16-1 English or Metric	\$ 125.00	\$ 90.00	16-1 English or Metric	\$ 160.00	
16-1/2 English or Metric	\$ 250.00	\$ 180.00	16-1/2 English or Metric	\$ 300.00	
112 English or Metric	\$ 300.00	\$ 220.00	112 English or Metric	\$ 315.00	
VC-1 English or Metric	\$ 125.00	\$ 90.00	VC-1 English or Metric	\$ 160.00	
DM-1 English or Metric	\$ 125.00	\$ 90.00	DM-1 English or Metric	\$ 160.00	
ADM - English or Metric	\$ 255.00	\$ 225.00	ADM - English or Metric	\$ 280.00	
QUIKCHEK			QUIKCHEK		
8"	Included		8"	\$ 325.00	
16"	Included		16"	\$ 440.00	
GEOMETRIC CHEK	N/A	Included	* GEOMETRIC CHEK	\$ 200.00	
Z AXIS CHEK	Included		Z AXIS CHEK	\$ 100.00	
Thread Wires			Thread Wires		
Standard sizes	\$60.00/set		Standard sizes	\$60.00/Set	

*Items or features of item may be outside of Accreditation scope.

GAGE MAKERS TOLERANCE CHART

ANSI/AMSE B89.1.5

DIAMETERS (INCH) ABOVE & INCLUDING	TOLERANCE CLASS					
	XXX	XX	X	Y	Z	ZZ
.010" - .825"	.000010"	.000020"	.000040"	.000070"	.0001"	.0002"
.825" - 1.510"	.000015"	.000030"	.000060"	.000090"	.00012"	.00024"
1.510" - 2.510"	.000020"	.000040"	.000080"	.00012"	.00016"	.00032"
2.510" - 4.510"	.000025"	.000050"	.0001"	.00015"	.0002"	.0004"
4.510" - 6.510"	.000033"	.000065"	.00013"	.00019"	.00025"	.0005"
6.510" - 9.010"	.000040"	.000080"	.00016"	.00024"	.00032"	.00064"
9.010" - 12.010"	.000050"	.0001"	.0002"	.0003"	.0004"	.0008"

DIAMETERS (METRIC) ABOVE & INCLUDING	TOLERANCE CLASS					
	XXX	XX	X	Y	Z	ZZ
.254mm to 20.96mm	.00025mm	.00051mm	.00102mm	.00178mm	.00254mm	.00508mm
20.96mm to 38.35mm	.00038mm	.00076mm	.00152mm	.00229mm	.00305mm	.00610mm
38.35mm to 63.75mm	.00051mm	.00102mm	.00203mm	.00305mm	.00406mm	.00813mm
63.75mm to 114.55mm	.00064mm	.00127mm	.00254mm	.00381mm	.00508mm	.01016mm
114.55mm to 165.35mm	.00084mm	.00165mm	.00330mm	.00483mm	.00635mm	.01270mm
165.35mm to 228.85mm	.00102mm	.00203mm	.00406mm	.00610mm	.00813mm	.01626mm
228.85mm to 305.05mm	.00127mm	.00254mm	.00508mm	.00762mm	.01016mm	.02032mm

TOLERANCE DIRECTION

TYPE OF PRODUCT	DIRECTION	
	GO	NO-GO
OD CYLINDRICALS (PLUGS)	PLUS	MINUS
ID CYLINDRICALS (RINGS)	MINUS	PLUS

CALCULATING GAGE TOLERANCES

To calculate gage tolerances, the general rule of thumb is to use 10% of your part tolerance. For example, if your part tolerance is $+0.002/-0.000$ then the tolerancing that should be placed on your gage would be $.0002$ "

PART FEATURE EXAMPLE	GAGE
Hole Size = $.7500 \pm .0002$ "	GO Plug Member = $.7498 + .00002/-0.0000$ (CL-XX) NO-GO Plug Member = $.7502 + .0000/-0.00002$ (CL-XX)

LIMITS FOR ROUNDNESS & STRAIGHTNESS (PLUGS)

DIAMETERS (INCH) ABOVE & INCLUDING	TOLERANCE CLASS					
	XXX	XX	X	Y	Z	ZZ
.010" - .825"	.000005"	.000010"	.000020"	.000035"	.000050"	.000100"
.825" - 1.510"	.000008"	.000015"	.000030"	.000045"	.000060"	.000120"
1.510" - 2.510"	.000010"	.000020"	.000040"	.000060"	.000080"	.000160"
2.510" - 4.510"	.000013"	.000025"	.000050"	.000075"	.000100"	.000200"
4.510" - 6.510"	.000016"	.000033"	.000065"	.000095"	.000125"	.000250"
6.510" - 9.010"	.000020"	.000040"	.000080"	.000120"	.000160"	.000320"
9.010" - 12.010"	.000025"	.000050"	.000100"	.000125"	.000200"	.000400"

ADDITIONAL INFO



Don't forget to check out the GSG website at www.gsgage.com for additional information and product updates.

**FEATURING NEW
PRODUCT AND
INSTRUCTIONAL
VIDEO'S**

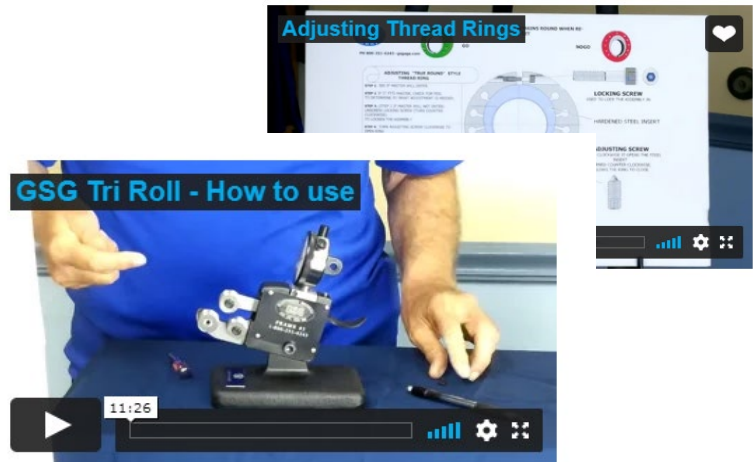

ADDITIONAL INFO

See our full line of surveillance products starting on page 33. GSG offers the most complete line of Surveillance Products on the market.

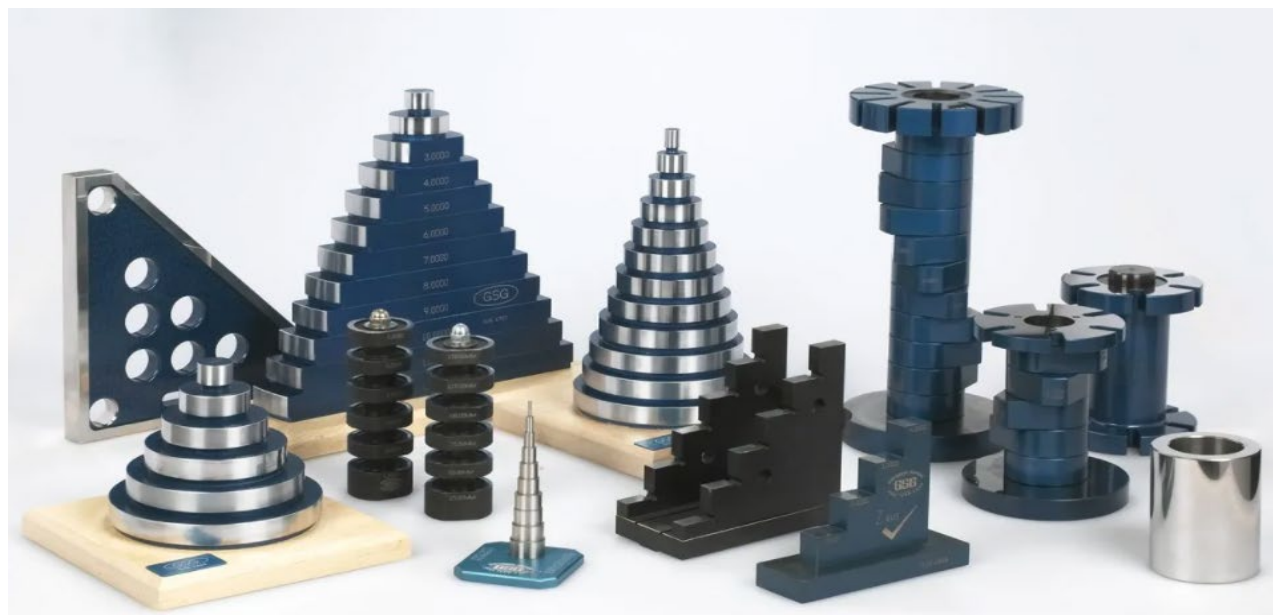

THREAD WORK PLUG GAGES

STEEL



All GSG Thread Work Plug Gages are manufactured to ASME/ANSI B1.2 or B1.16M (1983). Taperlock style up to 1.5 inch / M36, above are trilock style. Chip grooves are provided on all Go work plug members #10 / M4 and larger. All gages are made of hardened tool steel.

All stocked gages are marked in fraction. There is a \$10.00 charge per member to change the marking to decimal.

Nominal Size	Go Length "L"	NoGo Length "L"	METRIC		Member Price	Handle #	Handle Price	Double End Go/NoGo/Hdle Price
			Go Pitch Diameter	NoGo 6H Pitch Diameter				
M1.6 x 0.35	1/4	3/16	1.373	1.458	\$ 63.00	000	\$ 12.00	\$ 138.00
M1.8 x 0.35	1/4	3/16	1.573	1.658	\$ 63.00	000	\$ 12.00	\$ 138.00
M2.0 x 0.40	1/4	3/16	1.740	1.830	\$ 63.00	000	\$ 12.00	\$ 138.00
M2.2 x 0.45	1/4	3/16	1.908	2.003	\$ 63.00	000	\$ 12.00	\$ 138.00
M2.5 x 0.45	1/4	3/16	2.208	2.303	\$ 59.00	000	\$ 12.00	\$ 130.00
M3.0 x 0.50	5/16	7/32	2.675	2.775	\$ 59.00	00	\$ 12.00	\$ 130.00
M3.5 x 0.60	5/16	7/32	3.110	3.222	\$ 50.00	00	\$ 12.00	\$ 112.00
M4.0 x 0.70	13/32	9/32	3.545	3.663	\$ 50.00	0	\$ 12.00	\$ 112.00
M4.5 x 0.75	13/32	9/32	4.013	4.131	\$ 50.00	0	\$ 12.00	\$ 112.00
M5.0 x 0.80	13/32	9/32	4.480	4.605	\$ 50.00	0	\$ 12.00	\$ 112.00
M6.0 x 1.00	1/2	5/16	5.350	5.500	\$ 39.00	1	\$ 11.00	\$ 89.00
M7.0 x 1.00	1/2	5/16	6.350	6.500	\$ 39.00	1	\$ 11.00	\$ 89.00
M8.0 x 1.25	1/2	5/16	7.188	7.348	\$ 39.00	1	\$ 11.00	\$ 89.00
M8.0 x 1.00	1/2	5/16	7.350	7.500	\$ 39.00	1	\$ 11.00	\$ 89.00
M10.0 x 1.50	3/4	0.375	9.026	9.206	\$ 41.00	2	\$ 11.00	\$ 93.00
M10.0 x 1.25	3/4	3/8	9.188	9.348	\$ 41.00	2	\$ 11.00	\$ 93.00
M10.0 x 1.00	3/4	3/8	9.350	9.500	\$ 53.00	2	\$ 11.00	\$ 117.00
M12.0 x 1.75	3/4	3/8	10.863	11.063	\$ 46.00	2	\$ 11.00	\$ 103.00
M12.0 x 1.50	3/4	3/8	11.026	11.216	\$ 46.00	2	\$ 11.00	\$ 103.00
M12.0 x 1.25	3/4	3/8	11.188	11.368	\$ 48.00	2	\$ 11.00	\$ 107.00
M12.0 x 1.00	3/4	3/8	11.350	11.510	\$ 53.00	2	\$ 11.00	\$ 117.00
M14.0 x 2.00	7/8	1/2	12.701	12.913	\$ 52.00	3	\$ 11.00	\$ 115.00
M14.0 x 1.50	7/8	1/2	13.026	13.216	\$ 52.00	3	\$ 11.00	\$ 115.00
M14.0 x 1.00	7/8	1/2	13.350	13.510	\$ 108.00	3	\$ 11.00	\$ 227.00
M15.0 x 1.00	7/8	1/2	14.350	14.510	\$ 52.00	3	\$ 11.00	\$ 115.00
M16.0 x 2.00	7/8	1/2	14.701	14.913	\$ 52.00	3	\$ 11.00	\$ 115.00
M16.0 x 1.50	7/8	1/2	15.026	15.216	\$ 52.00	3	\$ 11.00	\$ 115.00
M17.0 x 1.00	7/8	1/2	16.350	16.510	\$ 54.00	3	\$ 11.00	\$ 119.00
M18.0 x 2.50	7/8	1/2	16.376	16.600	\$ 58.00	3	\$ 11.00	\$ 127.00
M18.0 x 1.50	7/8	1/2	17.026	17.216	\$ 58.00	3	\$ 11.00	\$ 127.00
M20.0 x 2.50	7/8	1/2	18.376	18.600	\$ 73.00	3	\$ 11.00	\$ 157.00
M20.0 x 1.50	7/8	1/2	19.026	19.216	\$ 64.00	3	\$ 11.00	\$ 139.00
M22.0 x 2.50	1	5/8	20.376	20.600	\$ 64.00	4	\$ 12.00	\$ 140.00
M22.0 x 1.50	1	5/8	21.026	21.216	\$ 64.00	4	\$ 12.00	\$ 140.00
M24.0 x 3.00	1	5/8	22.051	22.316	\$ 73.00	4	\$ 12.00	\$ 158.00
M24.0 x 2.00	1	5/8	22.701	22.925	\$ 73.00	4	\$ 12.00	\$ 158.00
M27.0 x 3.00	1	5/8	25.051	25.316	\$ 97.00	4	\$ 12.00	\$ 206.00
M27.0 x 2.00	1	5/8	25.701	25.925	\$ 97.00	4	\$ 12.00	\$ 206.00
M30.0 x 3.50	1 1/4	3/4	27.727	28.007	\$ 130.00	5	\$ 13.00	\$ 273.00
M30.0 x 2.00	1	3/4	28.701	28.925	\$ 127.00	5	\$ 13.00	\$ 267.00
M30.0 x 1.50	1	3/4	29.026	29.226	\$ 127.00	5	\$ 13.00	\$ 267.00
M33.0 x 3.50	1 1/4	3/4	30.727	31.007	\$ 127.00	5	\$ 13.00	\$ 267.00
M33.0 x 2.00	1	3/4	31.701	31.925	\$ 127.00	5	\$ 13.00	\$ 267.00
M35.0 x 1.50	1	3/4	34.026	34.226	\$ 137.00	5	\$ 13.00	\$ 287.00
M36.0 x 4.00	1 1/4	3/4	33.402	33.702	\$ 144.00	5	\$ 13.00	\$ 301.00
M36.0 x 3.00	1 1/4	3/4	34.051	34.316	\$ 144.00	5	\$ 13.00	\$ 301.00
M36.0 x 2.00	1	3/4	34.701	34.925	\$ 144.00	5	\$ 13.00	\$ 301.00
M39.0 x 4.00	1 7/8	7/8	36.402	36.702	\$ 161.00	5 1/2	\$ 17.00	\$ 339.00
M39.0 x 3.00	1 1/4	7/8	37.051	37.316	\$ 161.00	5 1/2	\$ 17.00	\$ 339.00
M39.0 x 2.00	1 1/4	7/8	37.701	37.925	\$ 155.00	5 1/2	\$ 17.00	\$ 327.00

THREAD WORK PLUG GAGES

STEEL

Nominal Size	INCH					Member Price	Handle #	Handle Price	Double End Go/NoGo/Hdle Price
	Go Length "L"	NoGo Length "L"	Go Pitch Diameter	NoGo 2B Pitch Diameter	NoGo 3B Pitch Diameter				
0-80 (.060) UNF	1/4	3/16	0.0519	0.0542	0.0536	\$ 61.00	000	\$ 12.00	\$ 134.00
1-64 (.073) UNC	1/4	3/16	0.0629	0.0655	0.0648	\$ 61.00	000	\$ 12.00	\$ 134.00
1-72 (.073) UNF	1/4	3/16	0.0640	0.0665	0.0659	\$ 61.00	000	\$ 12.00	\$ 134.00
2-56 (.086) UNC	1/4	3/16	0.0744	0.0772	0.0765	\$ 58.00	000	\$ 12.00	\$ 128.00
2-64 (.086) UNF	1/4	3/16	0.0759	0.0786	0.0779	\$ 58.00	000	\$ 12.00	\$ 128.00
3-48 (.099) UNC	1/4	3/16	0.0855	0.0885	0.0877	\$ 52.00	000	\$ 12.00	\$ 116.00
3-56 (.099) UNF	1/4	3/16	0.0874	0.0902	0.0895	\$ 52.00	000	\$ 12.00	\$ 116.00
4-40 (.112) UNC	5/16	7/32	0.0958	0.0991	0.0982	\$ 46.00	00	\$ 12.00	\$ 104.00
4-48 (.112) UNF	5/16	7/32	0.0985	0.1016	0.1008	\$ 48.00	00	\$ 12.00	\$ 108.00
5-40 (.125) UNC	5/16	7/32	0.1088	0.1121	0.1113	\$ 43.00	00	\$ 12.00	\$ 98.00
5-44 (.125) UNF	5/16	7/32	0.1102	0.1134	0.1126	\$ 43.00	00	\$ 12.00	\$ 98.00
6-32 (.138) UNC	5/16	7/32	0.1177	0.1214	0.1204	\$ 40.00	00	\$ 12.00	\$ 92.00
6-40 (.138) UNF	5/16	7/32	0.1218	0.1252	0.1243	\$ 40.00	00	\$ 12.00	\$ 92.00
8-32 (.164) UNC	13/32	9/32	0.1437	0.1475	0.1465	\$ 40.00	0	\$ 12.00	\$ 92.00
8-36 (.164) UNF	13/32	9/32	0.1460	0.1496	0.1487	\$ 40.00	0	\$ 12.00	\$ 92.00
10-24 (.190) UNC	13/32	9/32	0.1629	0.1672	0.1661	\$ 40.00	0	\$ 12.00	\$ 92.00
10-32 (.190) UNF	13/32	9/32	0.1697	0.1736	0.1726	\$ 40.00	0	\$ 12.00	\$ 92.00
12-24 (.216) UNC	13/32	9/32	0.1889	0.1933	0.1922	\$ 40.00	0	\$ 12.00	\$ 92.00
12-28 (.216) UNF	13/32	9/32	0.1928	0.1970	0.1959	\$ 40.00	0	\$ 12.00	\$ 92.00
12-32 (.216) UNEF	13/32	9/32	0.1957	0.1998	0.1988	\$ 53.00	0	\$ 12.00	\$ 118.00
1/4-20 UNC	1/2	5/16	0.2175	0.2224	0.2211	\$ 38.00	1	\$ 11.00	\$ 87.00
1/4-28 UNF	1/2	5/16	0.2268	0.2311	0.2300	\$ 38.00	1	\$ 11.00	\$ 87.00
1/4-32 UNEF	1/2	5/16	0.2297	0.2339	0.2328	\$ 66.00	1	\$ 11.00	\$ 143.00
5/16-18 UNC	1/2	5/16	0.2764	0.2817	0.2803	\$ 38.00	1	\$ 11.00	\$ 87.00
5/16-24 UNF	1/2	5/16	0.2854	0.2902	0.2890	\$ 38.00	1	\$ 11.00	\$ 87.00
5/16-32 UNEF	1/2	5/16	0.2922	0.2964	0.2953	\$ 66.00	1	\$ 11.00	\$ 143.00
3/8-16 UNC	3/4	3/8	0.3344	0.3401	0.3387	\$ 38.00	2	\$ 11.00	\$ 87.00
3/8-24 UNF	3/4	3/8	0.3479	0.3528	0.3516	\$ 38.00	2	\$ 11.00	\$ 87.00
3/8-32 UNEF	3/4	3/8	0.3547	0.3591	0.3580	\$ 76.00	2	\$ 11.00	\$ 163.00
7/16-14 UNC	3/4	3/8	0.3911	0.3972	0.3957	\$ 37.00	2	\$ 11.00	\$ 85.00
7/16-20 UNF	3/4	3/8	0.4050	0.4104	0.4091	\$ 37.00	2	\$ 11.00	\$ 85.00
7/16-28 UNEF	3/4	3/8	0.4143	0.4189	0.4178	\$ 76.00	2	\$ 11.00	\$ 163.00
1/2-13 UNC	3/4	3/8	0.4500	0.4565	0.4548	\$ 39.00	2	\$ 11.00	\$ 89.00
1/2-20 UNF	3/4	3/8	0.4675	0.4731	0.4717	\$ 39.00	2	\$ 11.00	\$ 89.00
1/2-28 UNEF	3/4	3/8	0.4768	0.4816	0.4804	\$ 77.00	2	\$ 11.00	\$ 165.00
9/16-12 UNC	7/8	1/2	0.5084	0.5152	0.5135	\$ 52.00	3	\$ 11.00	\$ 115.00
9/16-18 UNF	7/8	1/2	0.5264	0.5323	0.5308	\$ 52.00	3	\$ 11.00	\$ 115.00
9/16-24 UNEF	7/8	1/2	0.5354	0.5405	0.5392	\$ 88.00	3	\$ 11.00	\$ 187.00
5/8-11 UNC	7/8	1/2	0.5660	0.5732	0.5714	\$ 53.00	3	\$ 11.00	\$ 117.00
5/8-18 UNF	7/8	1/2	0.5889	0.5949	0.5934	\$ 53.00	3	\$ 11.00	\$ 117.00
5/8-24 UNEF	7/8	1/2	0.5979	0.6031	0.6018	\$ 88.00	3	\$ 11.00	\$ 187.00
11/16-24 UNEF	7/8	1/2	0.6604	0.6656	0.6643	\$ 88.00	3	\$ 11.00	\$ 187.00
3/4-10 UNC	7/8	1/2	0.6850	0.6927	0.6907	\$ 56.00	3	\$ 11.00	\$ 123.00
3/4-16 UNF	7/8	1/2	0.7094	0.7159	0.7143	\$ 56.00	3	\$ 11.00	\$ 123.00
3/4-20 UNEF	7/8	1/2	0.7175	0.7232	0.7218	\$ 89.00	3	\$ 11.00	\$ 189.00
13/16-20 UNEF	7/8	1/2	0.7800	0.7857	0.7843	\$ 99.00	3	\$ 11.00	\$ 209.00
7/8-9 UNC	1	5/8	0.8028	0.8110	0.8089	\$ 64.00	4	\$ 12.00	\$ 140.00
7/8-14 UNF	1	5/8	0.8286	0.8356	0.8339	\$ 62.00	4	\$ 12.00	\$ 136.00
7/8-20 UNEF	1	5/8	0.8425	0.8482	0.8468	\$ 99.00	4	\$ 12.00	\$ 210.00
15/16-20 UNEF	1	5/8	0.9050	0.9109	0.9094	\$ 100.00	4	\$ 12.00	\$ 212.00
1-8 UNC	1	5/8	0.9188	0.9276	0.9254	\$ 72.00	4	\$ 12.00	\$ 156.00
1-12 UNF	1	5/8	0.9459	0.9535	0.9516	\$ 72.00	4	\$ 12.00	\$ 156.00
1-14 UNS	1	5/8	0.9536	0.9609	0.9590	\$ 72.00	4	\$ 12.00	\$ 156.00
1-20 UNEF	1	5/8	0.9675	0.9734	0.9719	\$ 116.00	4	\$ 12.00	\$ 244.00
1 1/16-12 UN	1	5/8	1.0084	1.0158	1.0139	\$ 127.00	4	\$ 12.00	\$ 266.00
1 1/16-18 UNEF	1	5/8	1.0264	1.0326	1.0310	\$ 119.00	4	\$ 12.00	\$ 250.00
1 1/8-7 UNC	1	5/8	1.0322	1.0416	1.0393	\$ 89.00	4	\$ 12.00	\$ 190.00
1 1/8-12 UNF	1	5/8	1.0709	1.0787	1.0768	\$ 89.00	4	\$ 12.00	\$ 190.00
1 1/8-18 UNEF	1	5/8	1.0889	1.0951	1.0935	\$ 117.00	4	\$ 12.00	\$ 246.00
1 3/16-12 UN	1	3/4	1.1334	1.1409	1.1390	\$ 125.00	5	\$ 13.00	\$ 263.00
1 3/16-18 UNEF	1	3/4	1.1514	1.1577	1.1561	\$ 125.00	5	\$ 13.00	\$ 263.00
1 1/4-7 UNC	1 1/4	3/4	1.1572	1.1668	1.1644	\$ 98.00	5	\$ 13.00	\$ 209.00
1 1/4-12 UNF	1	3/4	1.1959	1.2039	1.2019	\$ 98.00	5	\$ 13.00	\$ 209.00
1 1/4-18 UNEF	1	3/4	1.2139	1.2202	1.2186	\$ 120.00	5	\$ 13.00	\$ 253.00
1 5/16-12 UN	1	3/4	1.2584	1.2659	1.2640	\$ 136.00	5	\$ 13.00	\$ 285.00
1 5/16-18 UNEF	1	3/4	1.2764	1.2827	1.2811	\$ 136.00	5	\$ 13.00	\$ 285.00
1 3/8-6 UNC	1 1/4	3/4	1.2667	1.2771	1.2745	\$ 105.00	5	\$ 13.00	\$ 270.00
1 3/8-12 UNF	1	3/4	1.3209	1.3291	1.3270	\$ 105.00	5	\$ 13.00	\$ 270.00
1 3/8-18 UNEF	1	3/4	1.3389	1.3452	1.3436	\$ 143.00	5	\$ 13.00	\$ 299.00
1 7/16-12 UN	1	3/4	1.3834	1.3910	1.3891	\$ 147.00	5	\$ 13.00	\$ 307.00
1 7/16-18 UNEF	1	3/4	1.4014	1.4079	1.4062	\$ 147.00	5	\$ 13.00	\$ 307.00
1 1/2-6 UNC	1 1/4	3/4	1.3917	1.4022	1.3996	\$ 117.00	5	\$ 13.00	\$ 247.00
1 1/2-12 UNF	1	3/4	1.4459	1.4542	1.4522	\$ 117.00	5	\$ 13.00	\$ 247.00
1 1/2-18 UNEF	1	3/4	1.4639	1.4704	1.4687	\$ 155.00	5	\$ 13.00	\$ 323.00
1 5/8-12 UN	1 1/4	7/8	1.5709	1.5785	1.5766	\$ 185.00	5.5	\$ 17.00	\$ 387.00
1 3/4-12 UN	1 1/4	7/8	1.6959	1.7037	1.7017	\$ 200.00	5.5	\$ 17.00	\$ 417.00
1 7/8-12 UN	1 1/4	7/8	1.8209	1.8287	1.8267	\$ 203.00	5.5	\$ 17.00	\$ 423.00
2-12 UN	1 1/4	7/8	1.9459	1.9538	1.9518	\$ 212.00	6	\$ 17.00	\$ 441.00
2 1/4-12 UN	1 3/8	7/8	2.1959	2.2038	2.2018	\$ 220.00	6	\$ 17.00	\$ 457.00
2 1/2-12 UN	1 3/8	7/8	2.4459	2.4540	2.4519	\$ 248.00	6	\$ 17.00	\$ 513.00

THREAD WORK PLUG GAGES

CHROME

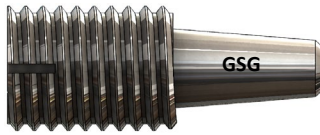

GO



NO-GO

All GSG Thread Work Plug Gages are manufactured to ASME/ANSI B1.2 or B1.16M (1983). Taperlock style up to 1.5 inch / M36, above are trilock style. Chip grooves are provided on all Go work plug members #10 / M4 and larger. All gages are made of hardened tool steel.

All stocked gages are marked in fraction. There is a \$10.00 charge per member to change the marking to decimal.

METRIC								
Nominal Size	Go Length "L"	NoGo Length "L"	Go Pitch Diameter	NoGo Pitch Diameter	Member Price	Handle #	Handle Price	Double End Go/NoGo/Hdle Price
M1.6 x 0.35	1/4	3/16	1.373	1.458	\$ 72.00	000	\$ 12.00	\$ 156.00
M1.8 x 0.35	1/4	3/16	1.573	1.658	\$ 72.00	000	\$ 12.00	\$ 156.00
M2.0 x 0.40	1/4	3/16	1.740	1.830	\$ 72.00	000	\$ 12.00	\$ 156.00
M2.2 x 0.45	1/4	3/16	1.908	2.003	\$ 72.00	000	\$ 12.00	\$ 156.00
M2.5 x 0.45	1/4	3/16	2.208	2.303	\$ 68.00	000	\$ 12.00	\$ 148.00
M3.0 x 0.50	5/16	7/32	2.675	2.775	\$ 68.00	00	\$ 12.00	\$ 148.00
M3.5 x 0.60	5/16	7/32	3.110	3.222	\$ 57.00	00	\$ 12.00	\$ 126.00
M4.0 x 0.70	13/32	9/32	3.545	3.663	\$ 57.00	0	\$ 12.00	\$ 126.00
M4.5 x 0.75	13/32	9/32	4.013	4.131	\$ 57.00	0	\$ 12.00	\$ 126.00
M5.0 x 0.80	13/32	9/32	4.480	4.605	\$ 57.00	0	\$ 12.00	\$ 126.00
M6.0 x 1.00	1/2	5/16	5.350	5.500	\$ 44.00	1	\$ 11.00	\$ 99.00
M7.0 x 1.00	1/2	5/16	6.350	6.500	\$ 44.00	1	\$ 11.00	\$ 99.00
M8.0 x 1.25	1/2	5/16	7.188	7.348	\$ 44.00	1	\$ 11.00	\$ 99.00
M8.0 x 1.00	1/2	5/16	7.350	7.500	\$ 44.00	1	\$ 11.00	\$ 99.00
M10.0 x 1.50	3/4	3/8	9.026	9.206	\$ 47.00	2	\$ 11.00	\$ 105.00
M10.0 x 1.25	3/4	3/8	9.188	9.348	\$ 47.00	2	\$ 11.00	\$ 105.00
M10.0 x 1.00	3/4	3/8	9.350	9.500	\$ 61.00	2	\$ 11.00	\$ 133.00
M12.0 x 1.75	3/4	3/8	10.863	11.063	\$ 53.00	2	\$ 11.00	\$ 117.00
M12.0 x 1.50	3/4	3/8	11.026	11.216	\$ 53.00	2	\$ 11.00	\$ 117.00
M12.0 x 1.25	3/4	3/8	11.188	11.368	\$ 56.00	2	\$ 11.00	\$ 123.00
M12.0 x 1.00	3/4	3/8	11.350	11.510	\$ 61.00	2	\$ 11.00	\$ 133.00
M14.0 x 2.00	7/8	1/2	12.701	12.913	\$ 59.00	3	\$ 11.00	\$ 129.00
M14.0 x 1.50	7/8	1/2	13.026	13.216	\$ 59.00	3	\$ 11.00	\$ 129.00
M14.0 x 1.00	7/8	1/2	13.350	13.510	\$ 124.00	3	\$ 11.00	\$ 259.00
M15.0 x 1.00	7/8	1/2	14.350	14.510	\$ 59.00	3	\$ 11.00	\$ 129.00
M16.0 x 2.00	7/8	1/2	14.701	14.913	\$ 59.00	3	\$ 11.00	\$ 129.00
M16.0 x 1.50	7/8	1/2	15.026	15.216	\$ 59.00	3	\$ 11.00	\$ 129.00
M17.0 x 1.00	7/8	1/2	16.350	16.510	\$ 62.00	3	\$ 11.00	\$ 135.00
M18.0 x 2.50	7/8	1/2	16.376	16.600	\$ 67.00	3	\$ 11.00	\$ 145.00
M18.0 x 1.50	7/8	1/2	17.026	17.216	\$ 67.00	3	\$ 11.00	\$ 145.00
M20.0 x 2.50	7/8	1/2	18.376	18.600	\$ 83.00	3	\$ 11.00	\$ 177.00
M20.0 x 1.50	7/8	1/2	19.026	19.216	\$ 73.00	3	\$ 11.00	\$ 157.00
M22.0 x 2.50	1	5/8	20.376	20.600	\$ 73.00	4	\$ 12.00	\$ 158.00
M22.0 x 1.50	1	5/8	21.026	21.216	\$ 73.00	4	\$ 12.00	\$ 158.00
M24.0 x 3.00	1	5/8	22.051	22.316	\$ 83.00	4	\$ 12.00	\$ 178.00
M24.0 x 2.00	1	5/8	22.701	22.925	\$ 83.00	4	\$ 12.00	\$ 178.00
M27.0 x 3.00	1	5/8	25.051	25.316	\$ 111.00	4	\$ 12.00	\$ 234.00
M27.0 x 2.00	1	5/8	25.701	25.925	\$ 111.00	4	\$ 12.00	\$ 234.00
M30.0 x 3.50	1 1/4	3/4	27.727	28.007	\$ 150.00	5	\$ 13.00	\$ 313.00
M30.0 x 2.00	1	3/4	28.701	28.925	\$ 146.00	5	\$ 13.00	\$ 305.00
M30.0 x 1.50	1	3/4	29.026	29.226	\$ 146.00	5	\$ 13.00	\$ 305.00
M33.0 x 3.50	1 1/4	3/4	30.727	31.007	\$ 146.00	5	\$ 13.00	\$ 305.00
M33.0 x 2.00	1	3/4	31.701	31.925	\$ 146.00	5	\$ 13.00	\$ 305.00
M35.0 x 1.50	1	3/4	34.026	34.226	\$ 157.00	5	\$ 13.00	\$ 327.00
M36.0 x 4.00	1 1/4	3/4	33.402	33.702	\$ 166.00	5	\$ 13.00	\$ 345.00
M36.0 x 3.00	1 1/4	3/4	34.051	34.316	\$ 166.00	5	\$ 13.00	\$ 345.00
M36.0 x 2.00	1	3/4	34.701	34.925	\$ 166.00	5	\$ 13.00	\$ 345.00
M39.0 x 4.00	1 7/8	7/8	36.402	36.702	\$ 185.00	5 1/2	\$ 17.00	\$ 387.00
M39.0 x 3.00	1 1/4	7/8	37.051	37.316	\$ 185.00	5 1/2	\$ 17.00	\$ 387.00
M39.0 x 2.00	1 1/4	7/8	37.701	37.925	\$ 178.00	5 1/2	\$ 17.00	\$ 373.00

THREAD WORK PLUG GAGES

CHROME

INCH									
Nominal Size	Go Length "L"	NoGo Length "L"	Go Pitch Diameter	NoGo 2B Pitch Diameter	NoGo 3B Pitch Diameter	Member Price	Handle #	Handle Price	Double End Go/NoGo/Hdle Price
0-80 (.060) UNF	1/4	3/16	0.0519	0.0542	0.0536	\$ 70.00	000	\$ 12.00	\$ 152.00
1-64 (.073) UNC	1/4	3/16	0.0629	0.0655	0.0648	\$ 70.00	000	\$ 12.00	\$ 152.00
1-72 (.073) UNF	1/4	3/16	0.0640	0.0665	0.0659	\$ 70.00	000	\$ 12.00	\$ 152.00
2-56 (.086) UNC	1/4	3/16	0.0744	0.0772	0.0765	\$ 67.00	000	\$ 12.00	\$ 146.00
2-64 (.086) UNF	1/4	3/16	0.0759	0.0786	0.0779	\$ 67.00	000	\$ 12.00	\$ 146.00
3-48 (.099) UNF	1/4	3/16	0.0855	0.0885	0.0877	\$ 59.00	000	\$ 12.00	\$ 130.00
3-56 (.099) UNC	1/4	3/16	0.0874	0.0902	0.0895	\$ 59.00	000	\$ 12.00	\$ 130.00
4-40 (.112) UNC	5/16	7/32	0.0958	0.0991	0.0982	\$ 53.00	00	\$ 12.00	\$ 118.00
4-48 (.112) UNF	5/16	7/32	0.0985	0.1016	0.1008	\$ 56.00	00	\$ 12.00	\$ 124.00
5-40 (.125) UNC	5/16	7/32	0.1088	0.1121	0.1113	\$ 49.00	00	\$ 12.00	\$ 110.00
5-44 (.125) UNF	5/16	7/32	0.1102	0.1134	0.1126	\$ 49.00	00	\$ 12.00	\$ 110.00
6-32 (.138) UNC	5/16	7/32	0.1177	0.1214	0.1204	\$ 46.00	00	\$ 12.00	\$ 104.00
6-40 (.138) UNF	5/16	7/32	0.1218	0.1252	0.1243	\$ 46.00	00	\$ 12.00	\$ 104.00
8-32 (.164) UNC	13/32	9/32	0.1437	0.1475	0.1465	\$ 46.00	0	\$ 12.00	\$ 104.00
8-36 (.164) UNF	13/32	9/32	0.1460	0.1496	0.1487	\$ 46.00	0	\$ 12.00	\$ 104.00
10-24 (.190) UNC	13/32	9/32	0.1629	0.1672	0.1661	\$ 46.00	0	\$ 12.00	\$ 104.00
10-32 (.190) UNF	13/32	9/32	0.1697	0.1736	0.1726	\$ 46.00	0	\$ 12.00	\$ 104.00
12-24 (.216) UNC	13/32	9/32	0.1889	0.1933	0.1922	\$ 46.00	0	\$ 12.00	\$ 104.00
12-28 (.216) UNF	13/32	9/32	0.1928	0.1970	0.1959	\$ 46.00	0	\$ 12.00	\$ 104.00
12-32 (.216) UNEF	13/32	9/32	0.1957	0.1998	0.1988	\$ 61.00	0	\$ 12.00	\$ 134.00
1/4-20 UNC	1/2	5/16	0.2175	0.2224	0.2211	\$ 43.00	1	\$ 11.00	\$ 97.00
1/4-28 UNF	1/2	5/16	0.2268	0.2311	0.2300	\$ 43.00	1	\$ 11.00	\$ 97.00
1/4-32 UNEF	1/2	5/16	0.2297	0.2339	0.2328	\$ 76.00	1	\$ 11.00	\$ 163.00
5/16-18 UNC	1/2	5/16	0.2764	0.2817	0.2803	\$ 43.00	1	\$ 11.00	\$ 97.00
5/16-24 UNF	1/2	5/16	0.2854	0.2902	0.2890	\$ 43.00	1	\$ 11.00	\$ 97.00
5/16-32 UNEF	1/2	5/16	0.2922	0.2964	0.2953	\$ 76.00	1	\$ 11.00	\$ 163.00
3/8-16 UNC	3/4	3/8	0.3344	0.3401	0.3387	\$ 43.00	2	\$ 11.00	\$ 97.00
3/8-24 UNF	3/4	3/8	0.3479	0.3528	0.3516	\$ 43.00	2	\$ 11.00	\$ 97.00
3/8-32 UNEF	3/4	3/8	0.3547	0.3591	0.3580	\$ 87.00	2	\$ 11.00	\$ 185.00
7/16-14 UNC	3/4	3/8	0.3911	0.3972	0.3957	\$ 43.00	2	\$ 11.00	\$ 97.00
7/16-20 UNF	3/4	3/8	0.4050	0.4104	0.4091	\$ 43.00	2	\$ 11.00	\$ 97.00
7/16-28 UNEF	3/4	3/8	0.4143	0.4189	0.4178	\$ 87.00	2	\$ 11.00	\$ 185.00
1/2-13 UNC	3/4	3/8	0.4500	0.4565	0.4548	\$ 44.00	2	\$ 11.00	\$ 99.00
1/2-20 UNF	3/4	3/8	0.4675	0.4731	0.4717	\$ 44.00	2	\$ 11.00	\$ 99.00
1/2-28 UNEF	3/4	3/8	0.4768	0.4816	0.4804	\$ 89.00	2	\$ 11.00	\$ 189.00
9/16-12 UNC	7/8	1/2	0.5084	0.5152	0.5135	\$ 59.00	3	\$ 11.00	\$ 129.00
9/16-18 UNF	7/8	1/2	0.5264	0.5323	0.5308	\$ 59.00	3	\$ 11.00	\$ 129.00
9/16-24 UNEF	7/8	1/2	0.5354	0.5405	0.5392	\$ 101.00	3	\$ 11.00	\$ 213.00
5/8-11 UNC	7/8	1/2	0.5660	0.5732	0.5714	\$ 61.00	3	\$ 11.00	\$ 133.00
5/8-18 UNF	7/8	1/2	0.5889	0.5949	0.5934	\$ 61.00	3	\$ 11.00	\$ 133.00
5/8-24 UNEF	7/8	1/2	0.5979	0.6031	0.6018	\$ 101.00	3	\$ 11.00	\$ 213.00
11/16-24 UNEF	7/8	1/2	0.6604	0.6656	0.6643	\$ 101.00	3	\$ 11.00	\$ 213.00
3/4-10 UNC	7/8	1/2	0.6850	0.6927	0.6907	\$ 65.00	3	\$ 11.00	\$ 141.00
3/4-16 UNF	7/8	1/2	0.7094	0.7159	0.7143	\$ 65.00	3	\$ 11.00	\$ 141.00
3/4-20 UNEF	7/8	1/2	0.7175	0.7232	0.7218	\$ 102.00	3	\$ 11.00	\$ 215.00
13/16-20 UNEF	7/8	1/2	0.7800	0.7857	0.7843	\$ 114.00	3	\$ 11.00	\$ 239.00
7/8-9 UNC	1	5/8	0.8028	0.8110	0.8089	\$ 73.00	4	\$ 12.00	\$ 158.00
7/8-14 UNF	1	5/8	0.8286	0.8356	0.8339	\$ 71.00	4	\$ 12.00	\$ 154.00
7/8-20 UNEF	1	5/8	0.8425	0.8482	0.8468	\$ 114.00	4	\$ 12.00	\$ 240.00
15/16-20 UNEF	1	5/8	0.9050	0.9109	0.9094	\$ 115.00	4	\$ 12.00	\$ 242.00
1-8 UNC	1	5/8	0.9188	0.9276	0.9254	\$ 82.00	4	\$ 12.00	\$ 176.00
1-12 UNF	1	5/8	0.9459	0.9535	0.9516	\$ 82.00	4	\$ 12.00	\$ 176.00
1-14 UNS	1	5/8	0.9536	0.9609	0.9590	\$ 82.00	4	\$ 12.00	\$ 176.00
1-20 UNEF	1	5/8	0.9675	0.9734	0.9719	\$ 133.00	4	\$ 12.00	\$ 278.00
1 1/16-12 UN	1	5/8	1.0084	1.0158	1.0139	\$ 147.00	4	\$ 12.00	\$ 306.00
1 1/16-18 UNEF	1	5/8	1.0264	1.0326	1.0310	\$ 137.00	4	\$ 12.00	\$ 286.00
1 1/8-7 UNC	1	5/8	1.0322	1.0416	1.0393	\$ 102.00	4	\$ 12.00	\$ 216.00
1 1/8-12 UNF	1	5/8	1.0709	1.0787	1.0768	\$ 102.00	4	\$ 12.00	\$ 216.00
1 1/8-18 UNEF	1	5/8	1.0889	1.0951	1.0935	\$ 134.00	4	\$ 12.00	\$ 280.00
1 3/16-12 UN	1	3/4	1.1334	1.1409	1.1390	\$ 144.00	5	\$ 13.00	\$ 301.00
1 3/16-18 UNEF	1	3/4	1.1514	1.1577	1.1561	\$ 144.00	5	\$ 13.00	\$ 301.00
1 1/4-7 UNC	1 1/4	3/4	1.1572	1.1668	1.1644	\$ 113.00	5	\$ 13.00	\$ 239.00
1 1/4-12 UNF	1	3/4	1.1959	1.2039	1.2019	\$ 113.00	5	\$ 13.00	\$ 239.00
1 1/4-18 UNEF	1	3/4	1.2139	1.2202	1.2186	\$ 138.00	5	\$ 13.00	\$ 289.00
1 5/16-12 UN	1	3/4	1.2584	1.2659	1.2640	\$ 157.00	5	\$ 13.00	\$ 327.00
1 5/16-18 UNEF	1	3/4	1.2764	1.2827	1.2811	\$ 157.00	5	\$ 13.00	\$ 327.00
1 3/8-6 UNC	1 1/4	3/4	1.2667	1.2771	1.2745	\$ 120.00	5	\$ 13.00	\$ 253.00
1 3/8-12 UNF	1	3/4	1.3209	1.3291	1.3270	\$ 120.00	5	\$ 13.00	\$ 253.00
1 3/8-18 UNEF	1	3/4	1.3389	1.3452	1.3436	\$ 164.00	5	\$ 13.00	\$ 341.00
1 7/16-12 UN	1	3/4	1.3834	1.3910	1.3891	\$ 170.00	5	\$ 13.00	\$ 353.00
1 7/16-18 UNEF	1	3/4	1.4014	1.4079	1.4062	\$ 170.00	5	\$ 13.00	\$ 353.00
1 1/2-6 UNC	1 1/4	3/4	1.3917	1.4022	1.3996	\$ 134.00	5	\$ 13.00	\$ 281.00
1 1/2-12 UNF	1	3/4	1.4459	1.4542	1.4522	\$ 134.00	5	\$ 13.00	\$ 281.00
1 1/2-18 UNEF	1	3/4	1.4639	1.4704	1.4687	\$ 178.00	5	\$ 13.00	\$ 369.00
1 5/8-12 UN	1 1/4	7/8	1.5709	1.5785	1.5766	\$ 213.00	5.5	\$ 17.00	\$ 443.00
1 3/4-12 UN	1 1/4	7/8	1.6959	1.7037	1.7017	\$ 230.00	5.5	\$ 17.00	\$ 477.00
1 7/8-12 UN	1 1/4	7/8	1.8209	1.8287	1.8267	\$ 233.00	5.5	\$ 17.00	\$ 483.00
2-12 UN	1 1/4	7/8	1.9459	1.9538	1.9518	\$ 244.00	6	\$ 17.00	\$ 505.00
2 1/4-12 UN	1 3/8	7/8	2.1959	2.2038	2.2018	\$ 253.00	6	\$ 17.00	\$ 523.00
2 1/2-12 UN	1 3/8	7/8	2.4459	2.4540	2.4519	\$ 285.00	6	\$ 17.00	\$ 587.00

REVERSIBLE THREAD WORK PLUG GAGES STEEL

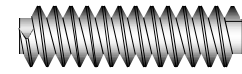
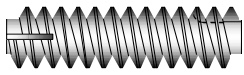

All GSG Thread Work Plug Gages are manufactured to ASME/ANSI B1.2 or B1.16M (1983). Chip grooves are provided on both ends of the GO work plug members #10 / M4 and larger. All gages are made of hardened tool steel.

All stocked gages are marked in fraction. There is a \$10.00 charge per member to change the marking to decimal.

METRIC							
Nominal Size	Length MM	Go Pitch Diameter	NoGo 6H Pitch Diameter	Member Price	Handle #	Handle Price	Double End Go/NoGo/Hdle Price
M1.6 x 0.35	12.7	1.373	1.458	\$ 95.00	1 WDE	\$ 13.00	\$ 203.00
M2.0 x 0.40	15.9	1.740	1.830	\$ 85.00	2 WDE	\$ 13.00	\$ 183.00
M2.5 x 0.45	15.9	2.208	2.303	\$ 85.00	2 WDE	\$ 13.00	\$ 183.00
M3.0 x 0.50	15.9	2.675	2.775	\$ 77.00	2 WDE	\$ 13.00	\$ 167.00
M3.5 x 0.60	19	3.110	3.222	\$ 71.00	2 WDE	\$ 13.00	\$ 155.00
M4.0 x 0.70	19	3.545	3.663	\$ 71.00	2 WDE	\$ 13.00	\$ 155.00
M5.0 x 0.80	22.2	4.480	4.605	\$ 71.00	3 WDE	\$ 14.00	\$ 156.00
M6.0 x 1.00	22.2	5.350	5.500	\$ 56.00	3 WDE	\$ 14.00	\$ 126.00
M8.0 x 1.25	25.4	7.188	7.348	\$ 56.00	4 WDE	\$ 15.00	\$ 127.00
M8.0 x 1.00	25.4	7.350	7.500	\$ 56.00	4 WDE	\$ 15.00	\$ 127.00
M10.0 x 1.50	28.6	9.026	9.206	\$ 59.00	4 WDE	\$ 15.00	\$ 133.00
M10.0 x 1.25	28.6	9.188	9.348	\$ 59.00	4 WDE	\$ 15.00	\$ 133.00
M12.0 x 1.75	34.9	10.863	11.063	\$ 64.00	5 WDE	\$ 15.00	\$ 143.00
M12.0 x 1.50	34.9	11.026	11.216	\$ 64.00	5 WDE	\$ 15.00	\$ 143.00
M12.0 x 1.25	34.9	11.188	11.368	\$ 64.00	5 WDE	\$ 15.00	\$ 143.00
M12.0 x 1.00	34.9	11.350	11.510	\$ 73.00	5 WDE	\$ 15.00	\$ 161.00
M14.0 x 2.00	38.1	12.701	12.913	\$ 73.00	6 WDE	\$ 16.00	\$ 162.00
M14.0 x 1.50	38.1	13.026	13.216	\$ 73.00	6 WDE	\$ 16.00	\$ 162.00
M16.0 x 2.00	38.1	14.701	14.913	\$ 76.00	6 WDE	\$ 16.00	\$ 168.00
M16.0 x 1.50	38.1	15.026	15.216	\$ 76.00	6 WDE	\$ 16.00	\$ 168.00
M18.0 x 1.50	44.4	17.026	17.216	\$ 80.00	6 WDE	\$ 16.00	\$ 176.00

INCH								
Nominal Size	Length Inch	Go Pitch Diameter	NoGo 2B Pitch Diameter	NoGo 3B Pitch Diameter	Member Price	Handle #	Handle Price	Double End Go/NoGo/Hdle Price
0-80 (.060) UNF	1/2	0.0519	0.0542	0.0536	\$ 86.00	1 WDE	\$ 13.00	\$ 185.00
1-64 (.073) UNC	1/2	0.0629	0.0655	0.0648	\$ 86.00	1 WDE	\$ 13.00	\$ 185.00
1-72 (.073) UNF	1/2	0.0640	0.0665	0.0659	\$ 86.00	1 WDE	\$ 13.00	\$ 185.00
2-56 (.086) UNC	5/8	0.0744	0.0772	0.0765	\$ 76.00	2 WDE	\$ 13.00	\$ 165.00
3-48 (.099) UNC	5/8	0.0855	0.0885	0.0877	\$ 72.00	2 WDE	\$ 13.00	\$ 157.00
3-56 (.099) UNF	5/8	0.0874	0.0902	0.0895	\$ 72.00	2 WDE	\$ 13.00	\$ 157.00
4-40 (.112) UNC	5/8	0.0958	0.0991	0.0982	\$ 67.00	2 WDE	\$ 13.00	\$ 147.00
4-48 (.112) UNF	5/8	0.0985	0.1016	0.1008	\$ 67.00	2 WDE	\$ 13.00	\$ 147.00
5-40 (.125) UNC	5/8	0.1088	0.1121	0.1113	\$ 61.00	2 WDE	\$ 13.00	\$ 135.00
6-32 (.138) UNC	3/4	0.1177	0.1214	0.1204	\$ 61.00	2 WDE	\$ 13.00	\$ 135.00
6-40 (.138) UNF	3/4	0.1218	0.1252	0.1243	\$ 61.00	2 WDE	\$ 13.00	\$ 135.00
8-32 (.164) UNC	3/4	0.1437	0.1475	0.1465	\$ 61.00	2 WDE	\$ 13.00	\$ 135.00
8-36 (.164) UNF	3/4	0.1460	0.1496	0.1487	\$ 61.00	2 WDE	\$ 13.00	\$ 135.00
10-24 (.190) UNC	3/4	0.1629	0.1672	0.1661	\$ 61.00	3 WDE	\$ 14.00	\$ 136.00
10-32 (.190) UNF	3/4	0.1697	0.1736	0.1726	\$ 61.00	3 WDE	\$ 14.00	\$ 136.00
12-24 (.216) UNC	7/8	0.1889	0.1933	0.1922	\$ 61.00	3 WDE	\$ 14.00	\$ 136.00
12-28 (.216) UNF	7/8	0.1928	0.1970	0.1959	\$ 61.00	3 WDE	\$ 14.00	\$ 136.00
1/4-20 UNC	7/8	0.2175	0.2224	0.2211	\$ 56.00	3 WDE	\$ 14.00	\$ 126.00
1/4-28 UNF	7/8	0.2268	0.2311	0.2300	\$ 56.00	3 WDE	\$ 14.00	\$ 126.00
5/16-18 UNC	1	0.2764	0.2817	0.2803	\$ 56.00	4 WDE	\$ 15.00	\$ 127.00
5/16-24 UNF	1	0.2854	0.2902	0.2890	\$ 56.00	4 WDE	\$ 15.00	\$ 127.00
3/8-16 UNC	1 1/8	0.3344	0.3401	0.3387	\$ 61.00	4 WDE	\$ 15.00	\$ 137.00
3/8-24 UNF	1 1/8	0.3479	0.3528	0.3516	\$ 61.00	4 WDE	\$ 15.00	\$ 137.00
7/16-14 UNC	1 1/4	0.3911	0.3972	0.3957	\$ 61.00	5 WDE	\$ 15.00	\$ 137.00
7/16-20 UNF	1 1/4	0.4050	0.4104	0.4091	\$ 61.00	5 WDE	\$ 15.00	\$ 137.00
1/2-13 UNC	1 3/8	0.4500	0.4565	0.4548	\$ 61.00	5 WDE	\$ 15.00	\$ 137.00
1/2-20 UNF	1 3/8	0.4675	0.4731	0.4717	\$ 61.00	5 WDE	\$ 15.00	\$ 137.00
9/16-18 UNF	1 1/2	0.5264	0.5323	0.5308	\$ 68.00	6 WDE	\$ 16.00	\$ 152.00
5/8-11 UNC	1 1/2	0.5660	0.5732	0.5714	\$ 68.00	6 WDE	\$ 16.00	\$ 152.00
5/8-18 UNF	1 1/2	0.5889	0.5949	0.5934	\$ 68.00	6 WDE	\$ 16.00	\$ 152.00
3/4-10 UNC	1 3/4	0.6850	0.6927	0.6907	\$ 77.00	7 WDE	\$ 16.00	\$ 170.00
3/4-16 UNF	1 3/4	0.7094	0.7159	0.7143	\$ 77.00	7 WDE	\$ 16.00	\$ 170.00

UNEF available, contact factory.

REVERSIBLE THREAD WORK PLUG GAGES

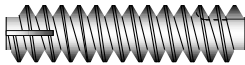

CHROME

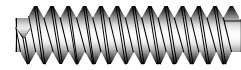

All GSG Thread Work Plug Gages are manufactured to ASME/ANSI B1.2 or B1.16M (1983). Chip grooves are provided on both ends of the GO work plug members #10 / M4 and larger. All gages are made of hardened tool steel.

All stocked gages are marked in fraction. There is a \$10.00 charge per member to change the marking to decimal.

METRIC							
Nominal Size	Length MM	Go Pitch Diameter	NoGo 6H Pitch Diameter	Member Price	Handle #	Handle Price	Double End Go/NoGo/Hdle Price
M1.6 x 0.35	12.7	1.373	1.458	\$ 110.00	1 WDE	\$ 13.00	\$ 233.00
M2.0 x 0.40	15.9	1.740	1.830	\$ 97.00	2 WDE	\$ 13.00	\$ 207.00
M2.5 x 0.45	15.9	2.208	2.303	\$ 97.00	2 WDE	\$ 13.00	\$ 207.00
M3.0 x 0.50	15.9	2.675	2.775	\$ 89.00	2 WDE	\$ 13.00	\$ 191.00
M3.5 x 0.60	19	3.110	3.222	\$ 81.00	2 WDE	\$ 13.00	\$ 175.00
M4.0 x 0.70	19	3.545	3.663	\$ 81.00	2 WDE	\$ 13.00	\$ 175.00
M5.0 x 0.80	22.2	4.480	4.605	\$ 81.00	3 WDE	\$ 14.00	\$ 176.00
M6.0 x 1.00	22.2	5.350	5.500	\$ 65.00	3 WDE	\$ 14.00	\$ 144.00
M8.0 x 1.25	25.4	7.188	7.348	\$ 65.00	4 WDE	\$ 15.00	\$ 145.00
M8.0 x 1.00	25.4	7.350	7.500	\$ 65.00	4 WDE	\$ 15.00	\$ 145.00
M10.0 x 1.50	28.6	9.026	9.206	\$ 68.00	4 WDE	\$ 15.00	\$ 151.00
M10.0 x 1.25	28.6	9.188	9.348	\$ 68.00	4 WDE	\$ 15.00	\$ 151.00
M12.0 x 1.75	34.9	10.863	11.063	\$ 73.00	5 WDE	\$ 15.00	\$ 161.00
M12.0 x 1.50	34.9	11.026	11.216	\$ 73.00	5 WDE	\$ 15.00	\$ 161.00
M12.0 x 1.25	34.9	11.188	11.368	\$ 73.00	5 WDE	\$ 15.00	\$ 161.00
M12.0 x 1.00	34.9	11.350	11.510	\$ 84.00	5 WDE	\$ 15.00	\$ 183.00
M14.0 x 2.00	38.1	12.701	12.913	\$ 83.00	6 WDE	\$ 16.00	\$ 182.00
M14.0 x 1.50	38.1	13.026	13.216	\$ 83.00	6 WDE	\$ 16.00	\$ 182.00
M16.0 x 2.00	38.1	14.701	14.913	\$ 87.00	6 WDE	\$ 16.00	\$ 190.00
M16.0 x 1.50	38.1	15.026	15.216	\$ 87.00	6 WDE	\$ 16.00	\$ 190.00
M18.0 x 1.50	44.4	17.026	17.216	\$ 92.00	6 WDE	\$ 16.00	\$ 200.00

INCH								
Nominal Size	Length Inch	Go Pitch Diameter	NoGo 2B Pitch Diameter	NoGo 3B Pitch Diameter	Member Price	Handle #	Handle Price	Double End Go/NoGo/Hdle Price
0-80 (.060) UNF	1/2	0.0519	0.0542	0.0536	\$ 99.00	1 WDE	\$ 13.00	\$ 211.00
1-64 (.073) UNC	1/2	0.0629	0.0655	0.0648	\$ 99.00	1 WDE	\$ 13.00	\$ 211.00
1-72 (.073) UNF	1/2	0.0640	0.0665	0.0659	\$ 99.00	1 WDE	\$ 13.00	\$ 211.00
2-56 (.086) UNC	5/8	0.0744	0.0772	0.0765	\$ 87.00	2 WDE	\$ 13.00	\$ 187.00
3-48 (.099) UNC	5/8	0.0855	0.0885	0.0877	\$ 82.00	2 WDE	\$ 13.00	\$ 177.00
3-56 (.099) UNF	5/8	0.0874	0.0902	0.0895	\$ 82.00	2 WDE	\$ 13.00	\$ 177.00
4-40 (.112) UNC	5/8	0.0958	0.0991	0.0982	\$ 77.00	2 WDE	\$ 13.00	\$ 167.00
4-48 (.112) UNF	5/8	0.0985	0.1016	0.1008	\$ 77.00	2 WDE	\$ 13.00	\$ 167.00
5-40 (.125) UNC	5/8	0.1088	0.1121	0.1113	\$ 70.00	2 WDE	\$ 13.00	\$ 153.00
6-32 (.138) UNC	3/4	0.1177	0.1214	0.1204	\$ 70.00	2 WDE	\$ 13.00	\$ 153.00
6-40 (.138) UNF	3/4	0.1218	0.1252	0.1243	\$ 70.00	2 WDE	\$ 13.00	\$ 153.00
8-32 (.164) UNC	3/4	0.1437	0.1475	0.1465	\$ 70.00	2 WDE	\$ 13.00	\$ 153.00
8-36 (.164) UNF	3/4	0.1460	0.1496	0.1487	\$ 70.00	2 WDE	\$ 13.00	\$ 153.00
10-24 (.190) UNC	3/4	0.1629	0.1672	0.1661	\$ 70.00	3 WDE	\$ 14.00	\$ 154.00
10-32 (.190) UNF	3/4	0.1697	0.1736	0.1726	\$ 70.00	3 WDE	\$ 14.00	\$ 154.00
12-24 (.216) UNC	7/8	0.1889	0.1933	0.1922	\$ 70.00	3 WDE	\$ 14.00	\$ 154.00
12-28 (.216) UNF	7/8	0.1928	0.1970	0.1959	\$ 70.00	3 WDE	\$ 14.00	\$ 154.00
1/4-20 UNC	7/8	0.2175	0.2224	0.2211	\$ 65.00	3 WDE	\$ 14.00	\$ 144.00
1/4-28 UNF	7/8	0.2268	0.2311	0.2300	\$ 65.00	3 WDE	\$ 14.00	\$ 144.00
5/16-18 UNC	1	0.2764	0.2817	0.2803	\$ 65.00	4 WDE	\$ 15.00	\$ 145.00
5/16-24 UNF	1	0.2854	0.2902	0.2890	\$ 65.00	4 WDE	\$ 15.00	\$ 145.00
3/8-16 UNC	1 1/8	0.3344	0.3401	0.3387	\$ 70.00	4 WDE	\$ 15.00	\$ 155.00
3/8-24 UNF	1 1/8	0.3479	0.3528	0.3516	\$ 70.00	4 WDE	\$ 15.00	\$ 155.00
7/16-14 UNC	1 1/4	0.3911	0.3972	0.3957	\$ 70.00	5 WDE	\$ 15.00	\$ 155.00
7/16-20 UNF	1 1/4	0.4050	0.4104	0.4091	\$ 70.00	5 WDE	\$ 15.00	\$ 155.00
1/2-13 UNC	1 3/8	0.4500	0.4565	0.4548	\$ 70.00	5 WDE	\$ 15.00	\$ 155.00
1/2-20 UNF	1 3/8	0.4675	0.4731	0.4717	\$ 70.00	5 WDE	\$ 15.00	\$ 155.00
9/16-18 UNF	1 1/2	0.5264	0.5323	0.5308	\$ 78.00	6 WDE	\$ 16.00	\$ 172.00
5/8-11 UNC	1 1/2	0.5660	0.5732	0.5714	\$ 78.00	6 WDE	\$ 16.00	\$ 172.00
5/8-18 UNF	1 1/2	0.5889	0.5949	0.5934	\$ 78.00	6 WDE	\$ 16.00	\$ 172.00
3/4-10 UNC	1 3/4	0.6850	0.6927	0.6907	\$ 89.00	7 WDE	\$ 16.00	\$ 194.00
3/4-16 UNF	1 3/4	0.7094	0.7159	0.7143	\$ 89.00	7 WDE	\$ 16.00	\$ 194.00

UNEF available, contact factory.



TRUE ROUND
(FORMERLY SOUTHERN STYLE)
THREAD RING GAGES



The True Round Adjustable Thread Ring Gage features an adjustment mechanism that maintains the roundness integrity of the gage throughout its use. Aluminum gage bodies anodized green for Go and red for NoGo provides quick positive identification, and are light weight for easy use. Inserts are made of oil hardened tool steel. Class and tolerances conform to ASME/ANSI B1.2 (1983) or B1.16M (1984). Sizes below 1/4 / M6 are counter bored to hold specified length.

All stocked gages are marked in fraction. There is a \$10.00 charge per member to change the marking to decimal.

METRIC							
Nominal Size	Go Length "L"	NoGo Length "L"	Go Pitch Diameter	NoGo 6g Pitch Diameter	STEEL Price Stocked	CHROME Price Non-Stocked	Holder Price
M1.6 x 0.35	3/32	3/32	1.354	1.291	\$ 218.00	N/A	\$ 21.00
M1.8 x 0.35	3/32	3/32	1.554	1.491	\$ 218.00	N/A	\$ 21.00
M2.0 x 0.40	3/32	3/32	1.721	1.654	\$ 202.00	N/A	\$ 21.00
M2.2 x 0.45	5/32	5/32	1.888	1.817	\$ 202.00	N/A	\$ 21.00
M2.5 x 0.45	5/32	5/32	2.188	2.117	\$ 202.00	N/A	\$ 21.00
M3.0 x 0.50	5/32	5/32	2.655	2.580	\$ 175.00	N/A	\$ 21.00
M3.5 x 0.60	5/32	5/32	3.089	3.004	\$ 175.00	N/A	\$ 21.00
M4.0 x 0.70	3/16	3/16	3.523	3.433	\$ 160.00	N/A	\$ 21.00
M4.5 x 0.75	3/16	3/16	3.991	3.901	\$ 160.00	N/A	\$ 21.00
M5.0 x 0.80	3/16	3/16	4.456	4.361	\$ 160.00	\$ 224.00	\$ 21.00
M6.0 x 1.00	11/32	11/32	5.324	5.212	\$ 143.00	\$ 200.00	\$ 22.00
M7.0 x 1.00	11/32	11/32	6.324	6.212	\$ 143.00	\$ 200.00	\$ 22.00
M8.0 x 1.25	11/32	11/32	7.160	7.042	\$ 143.00	\$ 200.00	\$ 22.00
M8.0 x 1.00	11/32	11/32	7.324	7.212	\$ 143.00	\$ 200.00	\$ 22.00
M10.0 x 1.50	7/16	7/16	8.994	8.862	\$ 152.00	\$ 213.00	\$ 23.00
M10.0 x 1.25	7/16	7/16	9.160	9.042	\$ 152.00	\$ 213.00	\$ 23.00
M12.0 x 1.75	7/16	7/16	10.829	10.679	\$ 161.00	\$ 225.00	\$ 23.00
M12.0 x 1.50	7/16	7/16	10.994	10.854	\$ 161.00	\$ 225.00	\$ 23.00
M12.0 x 1.25	7/16	7/16	11.160	11.028	\$ 158.00	\$ 221.00	\$ 23.00
M12.0 x 1.00	7/16	7/16	11.324	11.206	\$ 158.00	\$ 221.00	\$ 23.00
M14.0 x 2.00	9/16	9/16	12.663	12.503	\$ 187.00	\$ 262.00	\$ 26.00
M14.0 x 1.50	9/16	9/16	12.994	12.854	\$ 187.00	\$ 262.00	\$ 26.00
M14.0 x 1.00	9/16	9/16	13.324	13.206	\$ 187.00	\$ 262.00	\$ 26.00
M15.0 x 1.00	9/16	9/16	14.324	14.206	\$ 187.00	\$ 262.00	\$ 26.00
M16.0 x 2.00	9/16	9/16	14.663	14.503	\$ 187.00	\$ 262.00	\$ 26.00
M16.0 x 1.50	9/16	9/16	14.994	14.854	\$ 187.00	\$ 262.00	\$ 26.00
M17.0 x 1.00	9/16	9/16	16.324	16.206	\$ 244.00	\$ 342.00	\$ 26.00
M18.0 x 2.50	3/4	9/16	16.334	16.164	\$ 247.00	\$ 346.00	\$ 26.00
M18.0 x 1.50	9/16	9/16	16.994	16.854	\$ 247.00	\$ 346.00	\$ 26.00
M20.0 x 2.50	3/4	9/16	18.334	18.164	\$ 302.00	\$ 423.00	\$ 26.00
M20.0 x 1.50	9/16	9/16	18.994	18.854	\$ 302.00	\$ 423.00	\$ 26.00
M22.0 x 2.50	15/16	11/16	20.334	20.164	\$ 313.00	\$ 438.00	\$ 35.00
M22.0 x 1.50	11/16	11/16	20.994	20.854	\$ 313.00	\$ 438.00	\$ 35.00
M24.0 x 3.00	15/16	11/16	22.003	21.803	\$ 360.00	\$ 504.00	\$ 35.00
M24.0 x 2.00	11/16	11/16	22.663	22.493	\$ 360.00	\$ 504.00	\$ 35.00
M27.0 x 3.00	15/16	11/16	25.003	24.803	\$ 373.00	\$ 522.00	\$ 45.00
M27.0 x 2.00	11/16	11/16	25.663	25.493	\$ 373.00	\$ 522.00	\$ 45.00
M30.0 x 3.50	1 1/8	3/4	27.674	27.462	\$ 380.00	\$ 532.00	\$ 45.00
M30.0 x 2.00	3/4	3/4	28.663	28.493	\$ 380.00	\$ 532.00	\$ 45.00
M30.0 x 1.50	3/4	3/4	28.994	28.844	\$ 380.00	\$ 532.00	\$ 45.00
M33.0 x 3.50	1 1/8	3/4	30.674	30.462	\$ 420.00	\$ 588.00	\$ 45.00
M33.0 x 2.00	3/4	3/4	31.663	31.493	\$ 420.00	\$ 588.00	\$ 45.00
M35.0 x 1.50	3/4	3/4	33.994	33.844	\$ 446.00	\$ 624.00	\$ 45.00
M36.0 x 4.00	1 1/8	3/4	33.342	33.118	\$ 473.00	\$ 662.00	\$ 45.00
M36.0 x 3.00	1 1/8	3/4	34.003	33.803	\$ 473.00	\$ 662.00	\$ 45.00
M36.0 x 2.00	3/4	3/4	34.663	34.493	\$ 473.00	\$ 662.00	\$ 45.00
M39.0 x 4.00	1 1/4	13/16	36.342	36.118	\$ 477.00	\$ 668.00	N/A
M39.0 x 3.00	1 1/4	13/16	37.003	36.803	\$ 477.00	\$ 668.00	N/A
M39.0 x 2.00	13/16	13/16	37.663	37.493	\$ 477.00	\$ 668.00	N/A

TRUE ROUND
(FORMERLY SOUTHERN STYLE)
THREAD RING GAGES

INCH									
Nominal Size	Go Length "L"	NoGo Length "L"	Go 2A Pitch Diameter	NoGo 2A Pitch Diameter	Go 3A Pitch Diameter	NoGo 3A Pitch Diameter	STEEL Price Stocked	CHROME Price Non-Stocked	Holder Price
0-80 (.060) UNF	3/32	3/32	0.0514	0.0496	0.0519	0.0506	\$ 196.00	N/A	\$ 21.00
1-64 (.073) UNC	3/32	3/32	0.0623	0.0603	0.0629	0.0614	\$ 177.00	N/A	\$ 21.00
1-72 (.073) UNF	3/32	3/32	0.0634	0.0615	0.0640	0.0626	\$ 177.00	N/A	\$ 21.00
2-56 (.086) UNC	3/32	3/32	0.0738	0.0717	0.0744	0.0728	\$ 174.00	N/A	\$ 21.00
2-64 (.086) UNF	3/32	3/32	0.0753	0.0733	0.0759	0.0744	\$ 174.00	N/A	\$ 21.00
3-48 (.099) UNC	5/32	5/32	0.0848	0.0825	0.0855	0.0838	\$ 174.00	N/A	\$ 21.00
3-56 (.099) UNF	5/32	5/32	0.0867	0.0845	0.0874	0.0858	\$ 160.00	N/A	\$ 21.00
4-40 (.112) UNC	5/32	5/32	0.0950	0.0925	0.0958	0.0939	\$ 160.00	N/A	\$ 21.00
4-48 (.112) UNF	5/32	5/32	0.0978	0.0954	0.0985	0.0967	\$ 160.00	N/A	\$ 21.00
5-40 (.125) UNC	5/32	5/32	0.1080	0.1054	0.1088	0.1069	\$ 144.00	N/A	\$ 21.00
5-44 (.125) UNF	5/32	5/32	0.1095	0.1070	0.1102	0.1083	\$ 144.00	N/A	\$ 21.00
6-32 (.138) UNC	5/32	5/32	0.1169	0.1141	0.1177	0.1156	\$ 144.00	N/A	\$ 21.00
6-40 (.138) UNF	5/32	5/32	0.1210	0.1184	0.1218	0.1198	\$ 144.00	N/A	\$ 21.00
8-32 (.164) UNC	3/16	3/16	0.1428	0.1399	0.1437	0.1415	\$ 137.00	N/A	\$ 21.00
8-36 (.164) UNF	3/16	3/16	0.1452	0.1424	0.1460	0.1439	\$ 137.00	N/A	\$ 21.00
10-24 (.190) UNC	3/16	3/16	0.1619	0.1586	0.1629	0.1604	\$ 137.00	\$ 192.00	\$ 21.00
10-32 (.190) UNF	3/16	3/16	0.1688	0.1658	0.1697	0.1674	\$ 137.00	\$ 192.00	\$ 21.00
12-24 (.216) UNC	3/16	3/16	0.1879	0.1845	0.1889	0.1863	\$ 137.00	\$ 192.00	\$ 21.00
12-28 (.216) UNF	3/16	3/16	0.1918	0.1886	0.1928	0.1904	\$ 137.00	\$ 192.00	\$ 21.00
1/4-20 UNC	11/32	11/32	0.2164	0.2127	0.2175	0.2147	\$ 124.00	\$ 174.00	\$ 22.00
1/4-28 UNF	11/32	11/32	0.2258	0.2225	0.2268	0.2243	\$ 124.00	\$ 174.00	\$ 22.00
1/4-32 UNEF	11/32	11/32	0.2287	0.2255	0.2297	0.2273	\$ 179.00	\$ 251.00	\$ 22.00
5/16-18 UNC	11/32	11/32	0.2752	0.2712	0.2764	0.2734	\$ 124.00	\$ 174.00	\$ 22.00
5/16-24 UNF	11/32	11/32	0.2843	0.2806	0.2854	0.2827	\$ 124.00	\$ 174.00	\$ 22.00
5/16-32 UNEF	11/32	11/32	0.2912	0.2880	0.2922	0.2898	\$ 179.00	\$ 251.00	\$ 22.00
3/8-16 UNC	7/16	7/16	0.3331	0.3287	0.3344	0.3311	\$ 137.00	\$ 192.00	\$ 23.00
3/8-24 UNF	7/16	7/16	0.3468	0.3430	0.3479	0.3450	\$ 137.00	\$ 192.00	\$ 23.00
3/8-32 UNEF	7/16	7/16	0.3537	0.3503	0.3547	0.3522	\$ 180.00	\$ 252.00	\$ 23.00
7/16-14 UNC	7/16	7/16	0.3897	0.3850	0.3911	0.3876	\$ 137.00	\$ 192.00	\$ 23.00
7/16-20 UNF	7/16	7/16	0.4037	0.3995	0.4050	0.4019	\$ 137.00	\$ 192.00	\$ 23.00
7/16-28 UNEF	7/16	7/16	0.4132	0.4096	0.4143	0.4116	\$ 182.00	\$ 255.00	\$ 23.00
1/2-13 UNC	7/16	7/16	0.4485	0.4435	0.4500	0.4463	\$ 143.00	\$ 200.00	\$ 23.00
1/2-20 UNF	7/16	7/16	0.4662	0.4619	0.4675	0.4643	\$ 143.00	\$ 200.00	\$ 23.00
1/2-28 UNEF	7/16	7/16	0.4757	0.4720	0.4768	0.4740	\$ 183.00	\$ 256.00	\$ 23.00
9/16-12 UNC	3/4	3/4	0.5068	0.5016	0.5084	0.5045	\$ 154.00	\$ 216.00	\$ 26.00
9/16-18 UNF	9/16	9/16	0.5250	0.5205	0.5264	0.5230	\$ 154.00	\$ 216.00	\$ 26.00
9/16-24 UNEF	9/16	9/16	0.5342	0.5303	0.5354	0.5325	\$ 196.00	\$ 274.00	\$ 26.00
5/8-11 UNC	3/4	3/4	0.5644	0.5589	0.5660	0.5619	\$ 154.00	\$ 216.00	\$ 26.00
5/8-18 UNF	9/16	9/16	0.5875	0.5828	0.5889	0.5854	\$ 154.00	\$ 216.00	\$ 26.00
5/8-24 UNEF	9/16	9/16	0.5967	0.5927	0.5979	0.5949	\$ 200.00	\$ 280.00	\$ 26.00
11/16-24 UNEF	9/16	9/16	0.6592	0.6552	0.6604	0.6574	\$ 233.00	\$ 326.00	\$ 26.00
3/4-10 UNC	3/4	3/4	0.6832	0.6773	0.6850	0.6806	\$ 195.00	\$ 273.00	\$ 26.00
3/4-16 UNF	9/16	9/16	0.7079	0.7029	0.7094	0.7056	\$ 195.00	\$ 273.00	\$ 26.00
3/4-20 UNEF	9/16	9/16	0.7162	0.7118	0.7175	0.7142	\$ 236.00	\$ 330.00	\$ 26.00
13/16-20 UNEF	9/16	9/16	0.7787	0.7743	0.7800	0.7767	\$ 253.00	\$ 354.00	\$ 26.00
7/8-9 UNC	15/16	11/16	0.8009	0.7946	0.8028	0.7981	\$ 214.00	\$ 300.00	\$ 35.00
7/8-14 UNF	11/16	11/16	0.8270	0.8216	0.8286	0.8245	\$ 214.00	\$ 300.00	\$ 35.00
7/8-20 UNEF	11/16	11/16	0.8412	0.8368	0.8425	0.8392	\$ 257.00	\$ 360.00	\$ 35.00
15/16-20 UNEF	11/16	11/16	0.9036	0.8991	0.9050	0.9016	\$ 273.00	\$ 382.00	\$ 35.00
1-8 UNC	15/16	11/16	0.9168	0.9100	0.9188	0.9137	\$ 268.00	\$ 375.00	\$ 35.00
1-12 UNF	11/16	11/16	0.9441	0.9382	0.9459	0.9415	\$ 268.00	\$ 375.00	\$ 35.00
1-14 UNS	11/16	11/16	0.9519	0.9463	0.9536	0.9494	\$ 268.00	\$ 375.00	\$ 35.00
1-20 UNEF	11/16	11/16	0.9661	0.9616	0.9675	0.9641	\$ 299.00	\$ 419.00	\$ 35.00
1 1/16-12 UN	11/16	11/16	1.0067	1.0010	1.0084	1.0042	\$ 319.00	\$ 447.00	\$ 35.00
1 1/16-18 UNEF	11/16	11/16	1.0250	1.0203	1.0264	1.0228	\$ 319.00	\$ 447.00	\$ 35.00
1 1/8-7 UNC	15/16	11/16	1.0300	1.0228	1.0322	1.0268	\$ 324.00	\$ 454.00	\$ 35.00
1 1/8-12 UNF	11/16	11/16	1.0691	1.0631	1.0709	1.0664	\$ 324.00	\$ 454.00	\$ 35.00
1 1/8-18 UNEF	11/16	11/16	1.0875	1.0828	1.0889	1.0853	\$ 341.00	\$ 477.00	\$ 35.00
1 3/16-12 UN	3/4	3/4	1.1317	1.1259	1.1334	1.1291	\$ 342.00	\$ 479.00	\$ 45.00
1 3/16-18 UNEF	3/4	3/4	1.1499	1.1450	1.1514	1.1478	\$ 342.00	\$ 479.00	\$ 45.00
1 1/4-7 UNC	1 1/8	3/4	1.1550	1.1476	1.1572	1.1517	\$ 351.00	\$ 491.00	\$ 45.00
1 1/4-12 UNF	3/4	3/4	1.1941	1.1879	1.1959	1.1913	\$ 351.00	\$ 491.00	\$ 45.00
1 1/4-18 UNEF	3/4	3/4	1.2124	1.2075	1.2139	1.2103	\$ 358.00	\$ 501.00	\$ 45.00
1 5/16-12 UN	3/4	3/4	1.2567	1.2509	1.2584	1.2541	\$ 369.00	\$ 517.00	\$ 45.00
1 5/16-18 UNEF	3/4	3/4	1.2749	1.2700	1.2764	1.2728	\$ 369.00	\$ 517.00	\$ 45.00
1 3/8-6 UNC	1 1/8	3/4	1.2643	1.2563	1.2667	1.2607	\$ 360.00	\$ 504.00	\$ 45.00
1 3/8-12 UNF	3/4	3/4	1.3190	1.3127	1.3209	1.3162	\$ 360.00	\$ 504.00	\$ 45.00
1 3/8-18 UNEF	3/4	3/4	1.3374	1.3325	1.3389	1.3353	\$ 375.00	\$ 525.00	\$ 45.00
1 7/16-12 UN	3/4	3/4	1.3816	1.3757	1.3834	1.3790	\$ 382.00	\$ 535.00	\$ 45.00
1 7/16-18 UNEF	3/4	3/4	1.3999	1.3949	1.4014	1.3977	\$ 382.00	\$ 535.00	\$ 45.00
1 1/2-6 UNC	1 1/8	3/4	1.3893	1.3812	1.3917	1.3856	\$ 390.00	\$ 546.00	\$ 45.00
1 1/2-12 UNF	3/4	3/4	1.4440	1.4376	1.4459	1.4411	\$ 390.00	\$ 546.00	\$ 45.00
1 1/2-18 UNEF	3/4	3/4	1.4624	1.4574	1.4639	1.4602	\$ 412.00	\$ 577.00	\$ 45.00
1 5/8-12 UN	13/16	13/16	1.5691	1.5632	1.5709	1.5665	\$ 433.00	\$ 606.00	N/A
1 3/4-12 UN	13/16	13/16	1.6941	1.6881	1.6959	1.6914	\$ 456.00	\$ 638.00	N/A
1 7/8-12 UN	13/16	13/16	1.8191	1.8131	1.8209	1.8164	\$ 478.00	\$ 669.00	N/A
2-12 UN	13/16	13/16	1.9441	1.9380	1.9459	1.9414	\$ 504.00	\$ 706.00	N/A
2 1/4-12 UN	7/8	7/8	2.1941	2.1880	2.1959	2.1914	\$ 534.00	\$ 748.00	N/A
2 1/2-12 UN	7/8	7/8	2.4440	2.4378	2.4459	2.4413	\$ 585.00	\$ 819.00	N/A

AGD STYLE THREAD RING GAGES



The American Gage Design (AGD) adjustable Thread Ring Gage complies with ASME/ANSI B47.1 gage blank standard. AGD Style Thread Rings are made of hardened tool steel. Class and tolerance conform to ASME/ANSI B1.2 (1983) OR B1.16M (1984). Sizes below 1/4 / M6 are counter bored to hold specified length.

All stocked gages are marked in fraction. There is a \$10.00 charge per member to change the marking to decimal.

METRIC							
Nominal Price	Go Length "L"	NoGo Length "L"	Go Pitch Diameter	NoGo 6g Pitch Diameter	STEEL Price	CHROME Price	Holder Price
M 1.6 x 0.35	3/32	3/32	1.354	1.291	\$ 201.00	\$ 281.00	\$ 21.00
M 1.8 x 0.35	3/32	3/32	1.554	1.491	\$ 201.00	\$ 281.00	\$ 21.00
M 2.0 x 0.40	3/32	3/32	1.721	1.654	\$ 173.00	\$ 242.00	\$ 21.00
M 2.2 x 0.45	5/32	5/32	1.888	1.817	\$ 173.00	\$ 242.00	\$ 21.00
M 2.5 x 0.45	5/32	5/32	2.188	2.117	\$ 173.00	\$ 242.00	\$ 21.00
M 3.0 x 0.50	5/32	5/32	2.655	2.580	\$ 151.00	\$ 211.00	\$ 21.00
M 3.5 x 0.60	5/32	5/32	3.089	3.004	\$ 151.00	\$ 211.00	\$ 21.00
M 4.0 x 0.70	3/16	3/16	3.523	3.433	\$ 140.00	\$ 196.00	\$ 21.00
M 4.5 x 0.75	3/16	3/16	3.991	3.901	\$ 140.00	\$ 196.00	\$ 21.00
M 5.0 x 0.80	3/16	3/16	4.456	4.361	\$ 140.00	\$ 196.00	\$ 21.00
M 6.0 x 1.00	11/32	11/32	5.324	5.212	\$ 122.00	\$ 171.00	\$ 22.00
M 7.0 x 1.00	11/32	11/32	6.324	6.212	\$ 122.00	\$ 171.00	\$ 22.00
M 8.0 x 1.25	11/32	11/32	7.160	7.042	\$ 122.00	\$ 171.00	\$ 22.00
M 8.0 x 1.00	11/32	11/32	7.324	7.212	\$ 122.00	\$ 171.00	\$ 22.00
M 10.0 x 1.50	7/16	7/16	8.994	8.862	\$ 134.00	\$ 188.00	\$ 23.00
M 10.0 x 1.25	7/16	7/16	9.160	9.042	\$ 134.00	\$ 188.00	\$ 23.00
M 10.0 x 1.00	7/16	7/16	9.324	9.212	\$ 134.00	\$ 188.00	\$ 23.00
M 12.0 x 1.75	7/16	7/16	10.829	10.679	\$ 142.00	\$ 199.00	\$ 23.00
M 12.0 x 1.50	7/16	7/16	10.994	10.854	\$ 142.00	\$ 199.00	\$ 23.00
M 12.0 x 1.25	7/16	7/16	11.160	11.028	\$ 137.00	\$ 192.00	\$ 23.00
M 12.0 x 1.00	7/16	7/16	11.324	11.206	\$ 190.00	\$ 266.00	\$ 23.00
M 14.0 x 2.00	9/16	9/16	12.663	12.503	\$ 158.00	\$ 221.00	\$ 26.00
M 14.0 x 1.50	9/16	9/16	12.994	12.854	\$ 158.00	\$ 221.00	\$ 26.00
M 14.0 x 1.00	9/16	9/16	13.324	13.206	\$ 242.00	\$ 339.00	\$ 26.00
M 15.0 x 1.00	9/16	9/16	14.324	14.206	\$ 158.00	\$ 221.00	\$ 26.00
M 16.0 x 2.00	9/16	9/16	14.663	14.503	\$ 158.00	\$ 221.00	\$ 26.00
M 16.0 x 1.50	9/16	9/16	14.994	14.854	\$ 158.00	\$ 221.00	\$ 26.00
M 17.0 x 1.00	9/16	9/16	16.324	16.206	\$ 207.00	\$ 290.00	\$ 26.00
M 18.0 x 2.50	3/4	9/16	16.334	16.164	\$ 231.00	\$ 323.00	\$ 26.00
M 18.0 x 1.50	9/16	9/16	16.994	16.854	\$ 212.00	\$ 297.00	\$ 26.00
M 20.0 x 2.50	3/4	9/16	18.334	18.164	\$ 257.00	\$ 360.00	\$ 26.00
M 20.0 x 1.50	9/16	9/16	18.994	18.854	\$ 257.00	\$ 360.00	\$ 26.00
M 22.0 x 2.50	15/16	11/16	20.334	20.164	\$ 261.00	\$ 365.00	\$ 35.00
M 22.0 x 1.50	11/16	11/16	20.994	20.854	\$ 261.00	\$ 365.00	\$ 35.00
M 24.0 x 3.00	15/16	11/16	22.003	21.803	\$ 301.00	\$ 421.00	\$ 35.00
M 24.0 x 2.00	11/16	11/16	22.663	22.493	\$ 301.00	\$ 421.00	\$ 35.00
M 27.0 x 3.00	15/16	11/16	25.003	24.803	\$ 315.00	\$ 441.00	\$ 45.00
M 27.0 x 2.00	11/16	11/16	25.663	25.493	\$ 315.00	\$ 441.00	\$ 45.00
M 30.0 x 3.50	1 1/8	3/4	27.674	27.462	\$ 353.00	\$ 494.00	\$ 45.00
M 30.0 x 2.00	3/4	3/4	28.663	28.493	\$ 318.00	\$ 445.00	\$ 45.00
M 30.0 x 1.50	3/4	3/4	28.994	28.844	\$ 318.00	\$ 445.00	\$ 45.00
M 33.0 x 3.50	1 1/8	3/4	30.674	30.462	\$ 353.00	\$ 494.00	\$ 45.00
M 33.0 x 2.00	3/4	3/4	31.663	31.493	\$ 353.00	\$ 494.00	\$ 45.00
M 35.0 x 1.50	3/4	3/4	33.994	33.844	\$ 370.00	\$ 518.00	\$ 45.00
M 36.0 x 4.00	1 1/8	3/4	33.342	33.118	\$ 394.00	\$ 552.00	\$ 45.00
M 36.0 x 3.00	1 1/8	3/4	34.003	33.803	\$ 394.00	\$ 552.00	\$ 45.00
M 36.0 x 2.00	3/4	3/4	34.663	34.493	\$ 394.00	\$ 552.00	\$ 45.00
M 39.0 x 4.00	1 1/8	13/16	36.342	36.118	\$ 401.00	\$ 561.00	NA
M 39.0 x 3.00	1 1/8	13/16	37.003	36.803	\$ 401.00	\$ 561.00	NA
M 39.0 x 2.00	13/16	13/16	37.663	37.493	\$ 401.00	\$ 561.00	NA

AGD STYLE THREAD RING GAGES

INCH									
Nominal Size	Go Length "L"	NoGo Length "L"	Go 2A Pitch Diameter	NoGo 2A Pitch Diameter	Go 3A Pitch Diameter	NoGo 3A Pitch Diameter	STEEL Price	CHROME Price	Holder Price
0-80 (.060) UNF	3/32	3/32	0.0514	0.0496	0.0519	0.0506	\$ 173.00	\$ 242.00	\$ 21.00
1-64 (.073) UNC	3/32	3/32	0.0623	0.0603	0.0629	0.0614	\$ 157.00	\$ 220.00	\$ 21.00
1-72 (.073) UNF	3/32	3/32	0.0634	0.0615	0.0640	0.0626	\$ 157.00	\$ 220.00	\$ 21.00
2-56 (.086) UNC	3/32	3/32	0.0738	0.0717	0.0744	0.0728	\$ 147.00	\$ 206.00	\$ 21.00
2-64 (.086) UNF	3/32	3/32	0.0753	0.0733	0.0759	0.0744	\$ 147.00	\$ 206.00	\$ 21.00
3-48 (.099) UNC	5/32	5/32	0.0848	0.0825	0.0855	0.0838	\$ 147.00	\$ 206.00	\$ 21.00
3-56 (.099) UNF	5/32	5/32	0.0867	0.0845	0.0874	0.0858	\$ 147.00	\$ 206.00	\$ 21.00
4-40 (.112) UNC	5/32	5/32	0.0950	0.0925	0.0958	0.0939	\$ 136.00	\$ 190.00	\$ 21.00
4-48 (.112) UNF	5/32	5/32	0.0978	0.0954	0.0985	0.0967	\$ 136.00	\$ 190.00	\$ 21.00
5-40 (.125) UNC	5/32	5/32	0.1080	0.1054	0.1088	0.1069	\$ 118.00	\$ 165.00	\$ 21.00
5-44 (.125) UNF	5/32	5/32	0.1095	0.1070	0.1102	0.1083	\$ 118.00	\$ 165.00	\$ 21.00
6-32 (.138) UNC	5/32	5/32	0.1169	0.1141	0.1177	0.1156	\$ 118.00	\$ 165.00	\$ 21.00
6-40 (.138) UNF	5/32	5/32	0.1210	0.1184	0.1218	0.1198	\$ 118.00	\$ 165.00	\$ 21.00
8-32 (.164) UNC	3/16	3/16	0.1428	0.1399	0.1437	0.1415	\$ 113.00	\$ 158.00	\$ 21.00
8-36 (.164) UNF	3/16	3/16	0.1452	0.1424	0.1460	0.1439	\$ 113.00	\$ 158.00	\$ 21.00
10-24 (.190) UNC	3/16	3/16	0.1619	0.1586	0.1629	0.1604	\$ 113.00	\$ 158.00	\$ 21.00
10-32 (.190) UNF	3/16	3/16	0.1688	0.1658	0.1697	0.1674	\$ 113.00	\$ 158.00	\$ 21.00
12-24 (.216) UNC	3/16	3/16	0.1879	0.1845	0.1889	0.1863	\$ 113.00	\$ 158.00	\$ 21.00
12-28 (.216) UNF	3/16	3/16	0.1918	0.1886	0.1928	0.1904	\$ 113.00	\$ 158.00	\$ 21.00
12-32 (.216) UNEF	11/32	11/32	0.1948	0.1917	0.1957	0.1933	\$ 143.00	\$ 200.00	\$ 21.00
1/4-20 UNC	11/32	11/32	0.2164	0.2127	0.2175	0.2147	\$ 109.00	\$ 153.00	\$ 22.00
1/4-28 UNF	11/32	11/32	0.2258	0.2225	0.2268	0.2243	\$ 109.00	\$ 153.00	\$ 22.00
1/4-32 UNEF	11/32	11/32	0.2287	0.2255	0.2297	0.2273	\$ 137.00	\$ 192.00	\$ 22.00
5/16-18 UNC	11/32	11/32	0.2752	0.2712	0.2764	0.2734	\$ 106.00	\$ 148.00	\$ 22.00
5/16-24 UNF	11/32	11/32	0.2843	0.2806	0.2854	0.2827	\$ 106.00	\$ 148.00	\$ 22.00
5/16-32 UNEF	7/16	7/16	0.2912	0.2880	0.2922	0.2898	\$ 137.00	\$ 192.00	\$ 22.00
3/8-16 UNC	7/16	7/16	0.3331	0.3287	0.3344	0.3311	\$ 118.00	\$ 165.00	\$ 23.00
3/8-24 UNF	7/16	7/16	0.3468	0.3430	0.3479	0.3450	\$ 118.00	\$ 165.00	\$ 23.00
3/8-32 UNEF	7/16	7/16	0.3537	0.3503	0.3547	0.3522	\$ 143.00	\$ 200.00	\$ 23.00
7/16-14 UNC	7/16	7/16	0.3897	0.3850	0.3911	0.3876	\$ 112.00	\$ 157.00	\$ 23.00
7/16-20 UNF	7/16	7/16	0.4037	0.3995	0.4050	0.4019	\$ 112.00	\$ 157.00	\$ 23.00
7/16-28 UNEF	7/16	7/16	0.4132	0.4096	0.4143	0.4116	\$ 139.00	\$ 194.00	\$ 23.00
1/2-13 UNC	7/16	7/16	0.4485	0.4435	0.4500	0.4463	\$ 118.00	\$ 165.00	\$ 23.00
1/2-20 UNF	7/16	7/16	0.4662	0.4619	0.4675	0.4643	\$ 118.00	\$ 165.00	\$ 23.00
1/2-28 UNEF	3/4	9/16	0.4757	0.4720	0.4768	0.4740	\$ 144.00	\$ 202.00	\$ 23.00
9/16-12 UNC	9/16	9/16	0.5068	0.5016	0.5084	0.5045	\$ 137.00	\$ 192.00	\$ 26.00
9/16-18 UNF	9/16	9/16	0.5250	0.5205	0.5264	0.5230	\$ 137.00	\$ 192.00	\$ 26.00
9/16-24 UNEF	3/4	9/16	0.5342	0.5303	0.5354	0.5325	\$ 143.00	\$ 200.00	\$ 26.00
5/8-11 UNC	9/16	9/16	0.5644	0.5589	0.5660	0.5619	\$ 137.00	\$ 192.00	\$ 26.00
5/8-18 UNF	9/16	9/16	0.5875	0.5828	0.5889	0.5854	\$ 137.00	\$ 192.00	\$ 26.00
5/8-24 UNEF	9/16	9/16	0.5967	0.5927	0.5979	0.5949	\$ 189.00	\$ 265.00	\$ 26.00
11/16-24 UNEF	3/4	9/16	0.6592	0.6552	0.6604	0.6574	\$ 152.00	\$ 213.00	\$ 26.00
3/4-10 UNC	9/16	9/16	0.6832	0.6773	0.6850	0.6806	\$ 169.00	\$ 237.00	\$ 26.00
3/4-16 UNF	9/16	9/16	0.7079	0.7029	0.7094	0.7056	\$ 169.00	\$ 237.00	\$ 26.00
3/4-20 UNEF	9/16	9/16	0.7162	0.7118	0.7175	0.7142	\$ 207.00	\$ 290.00	\$ 26.00
13/16-20 UNEF	15/16	11/16	0.7787	0.7743	0.7800	0.7767	\$ 211.00	\$ 295.00	\$ 26.00
7/8-9 UNC	11/16	11/16	0.8009	0.7946	0.8028	0.7981	\$ 182.00	\$ 255.00	\$ 35.00
7/8-14 UNF	11/16	11/16	0.8270	0.8216	0.8286	0.8245	\$ 182.00	\$ 255.00	\$ 35.00
7/8-20 UNEF	11/16	11/16	0.8412	0.8368	0.8425	0.8392	\$ 218.00	\$ 305.00	\$ 35.00
15/16-20 UNEF	15/16	11/16	0.9036	0.8991	0.9050	0.9016	\$ 218.00	\$ 305.00	\$ 35.00
1-8 UNC	11/16	11/16	0.9168	0.9100	0.9188	0.9137	\$ 224.00	\$ 314.00	\$ 35.00
1-12 UNF	11/16	11/16	0.9441	0.9382	0.9459	0.9415	\$ 224.00	\$ 314.00	\$ 35.00
1-14 UNS	11/16	11/16	0.9519	0.9463	0.9536	0.9494	\$ 224.00	\$ 314.00	\$ 35.00
1-20 UNEF	11/16	11/16	0.9661	0.9616	0.9675	0.9641	\$ 254.00	\$ 356.00	\$ 35.00
1 1/16-12 UN	11/16	11/16	1.0067	1.0010	1.0084	1.0042	\$ 271.00	\$ 379.00	\$ 35.00
1 1/16-18 UNEF	15/16	11/16	1.0250	1.0203	1.0264	1.0228	\$ 285.00	\$ 400.00	\$ 35.00
1 1/8-7 UNC	11/16	11/16	1.0300	1.0228	1.0322	1.0268	\$ 289.00	\$ 405.00	\$ 35.00
1 1/8-12 UNF	11/16	11/16	1.0691	1.0631	1.0709	1.0664	\$ 289.00	\$ 405.00	\$ 35.00
1 1/8-18 UNEF	3/4	3/4	1.0875	1.0828	1.0889	1.0853	\$ 293.00	\$ 410.00	\$ 35.00
1 3/16-12 UN	3/4	3/4	1.1317	1.1259	1.1334	1.1291	\$ 296.00	\$ 414.00	\$ 35.00
1 3/16-18 UNEF	1 1/8	3/4	1.1499	1.1450	1.1514	1.1478	\$ 300.00	\$ 420.00	\$ 45.00
1 1/4-7 UNC	3/4	3/4	1.1550	1.1476	1.1572	1.1517	\$ 296.00	\$ 414.00	\$ 45.00
1 1/4-12 UNF	3/4	3/4	1.1941	1.1879	1.1959	1.1913	\$ 296.00	\$ 414.00	\$ 45.00
1 1/4-18 UNEF	3/4	3/4	1.2124	1.2075	1.2139	1.2103	\$ 303.00	\$ 424.00	\$ 45.00
1 5/16-12 UN	3/4	3/4	1.2567	1.2509	1.2584	1.2541	\$ 307.00	\$ 430.00	\$ 45.00
1 5/16-18 UNEF	1 1/8	3/4	1.2749	1.2700	1.2764	1.2728	\$ 309.00	\$ 433.00	\$ 45.00
1 3/8-6 UNC	3/4	3/4	1.2643	1.2563	1.2667	1.2607	\$ 305.00	\$ 427.00	\$ 45.00
1 3/8-12 UNF	3/4	3/4	1.3190	1.3127	1.3209	1.3162	\$ 305.00	\$ 427.00	\$ 45.00
1 3/8-18 UNEF	3/4	3/4	1.3374	1.3325	1.3389	1.3353	\$ 323.00	\$ 452.00	\$ 45.00
1 7/16-12 UN	3/4	3/4	1.3816	1.3757	1.3834	1.3790	\$ 323.00	\$ 452.00	\$ 45.00
1 7/16-18 UNEF	3/4	3/4	1.3999	1.3949	1.4014	1.3977	\$ 323.00	\$ 452.00	\$ 45.00
1 1/2-6 UNC	1 1/8	3/4	1.3893	1.3812	1.3917	1.3856	\$ 328.00	\$ 459.00	\$ 45.00
1 1/2-12 UNF	3/4	3/4	1.4440	1.4376	1.4459	1.4411	\$ 328.00	\$ 459.00	\$ 45.00
1 1/2-18 UNEF	3/4	3/4	1.4624	1.4574	1.4639	1.4602	\$ 348.00	\$ 487.00	\$ 45.00
1 5/8-12 UN	13/16	13/16	1.5691	1.5632	1.5709	1.5665	\$ 386.00	\$ 540.00	N/A
1 3/4-12 UN	13/16	13/16	1.6941	1.6881	1.6959	1.6914	\$ 386.00	\$ 540.00	N/A
1 7/8-12 UN	13/16	13/16	1.8191	1.8131	1.8209	1.8164	\$ 426.00	\$ 596.00	N/A
2"-12 UN	13/16	13/16	1.9441	1.9380	1.9459	1.9414	\$ 426.00	\$ 596.00	N/A
2 1/4-12 UN	7/8	7/8	2.1941	2.1880	2.1959	2.1914	\$ 455.00	\$ 637.00	N/A
2 1/2-12 UN	7/8	7/8	2.4440	2.4378	2.4459	2.4413	\$ 493.00	\$ 690.00	N/A

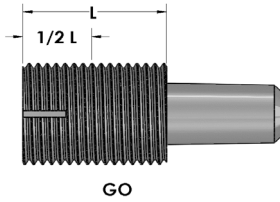

TRUNCATED SET PLUG GAGES

STEEL

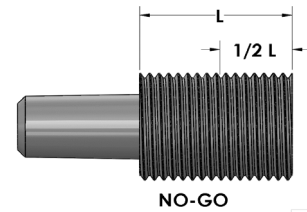

Truncated Set Plug Gages are used to set/calibrate Thread Ring Gages. Truncated Set Plug Gages have a common pitch diameter the full thread length with the front portion of the major diameter truncated leaving the rear portion full form. Truncated Set Plug Gages are manufactured to ASME/ANSI B47.1 AGD standard and ASME/ANSI B1.2 OR B1.16M (1983). Thread lead, flank angles & straightness conform to class W tolerances, pitch diameter conforms to class X tolerances. For pitch diameter to class W tolerances add 25% to the prices listed. All gages are manufactured of hardened tool steel. ***Progressive Set Masters (Hi-Lo) available upon request***

All stocked gages are marked in fraction. There is a \$10.00 charge per member to change the marking to decimal.

METRIC								
Nominal Size	Go Length "L"	NoGo Length "L"	Go Pitch Diameter	NoGo 6g Pitch Diameter	STEEL Price	Handle #	Handle Price	Double End Go/NoGo/Hdle Price
M1.6 x 0.35	7/32	7/32	1.354	1.291	\$ 136.00	000	\$ 12.00	\$ 284.00
M1.8 x 0.35	7/32	7/32	1.554	1.491	\$ 136.00	000	\$ 12.00	\$ 284.00
M2.0 x 0.40	7/32	7/32	1.721	1.654	\$ 128.00	000	\$ 12.00	\$ 268.00
M2.2 x 0.45	7/32	7/32	1.888	1.817	\$ 128.00	000	\$ 12.00	\$ 268.00
M2.5 x 0.45	3/8	3/8	2.188	2.117	\$ 128.00	000	\$ 12.00	\$ 268.00
M3.0 x 0.50	3/8	3/8	2.655	2.580	\$ 124.00	00	\$ 12.00	\$ 260.00
M3.5 x 0.60	3/8	3/8	3.089	3.004	\$ 124.00	00	\$ 12.00	\$ 260.00
M4.0 x 0.70	13/32	13/32	3.523	3.433	\$ 121.00	0	\$ 12.00	\$ 254.00
M4.5 x 0.75	13/32	13/32	3.991	3.901	\$ 121.00	0	\$ 12.00	\$ 254.00
M5.0 x 0.80	13/32	13/32	4.456	4.361	\$ 121.00	0	\$ 12.00	\$ 254.00
M6.0 x 1.00	3/4	3/4	5.324	5.212	\$ 109.00	1	\$ 11.00	\$ 229.00
M7.0 x 1.00	3/4	3/4	6.324	6.212	\$ 109.00	1	\$ 11.00	\$ 229.00
M8.0 x 1.25	3/4	3/4	7.160	7.042	\$ 109.00	1	\$ 11.00	\$ 229.00
M8.0 x 1.00	3/4	3/4	7.324	7.212	\$ 109.00	1	\$ 11.00	\$ 229.00
M10.0 x 1.50	1	1	8.994	8.862	\$ 116.00	2	\$ 11.00	\$ 243.00
M10.0 x 1.25	1	1	9.160	9.042	\$ 116.00	2	\$ 11.00	\$ 243.00
M10.0 x 1.00	1	1	9.324	9.212	\$ 116.00	2	\$ 11.00	\$ 243.00
M12.0 x 1.75	1	1	10.829	10.679	\$ 121.00	2	\$ 11.00	\$ 253.00
M12.0 x 1.50	1	1	10.994	10.854	\$ 121.00	2	\$ 11.00	\$ 253.00
M12.0 x 1.25	1	1	11.160	11.028	\$ 121.00	2	\$ 11.00	\$ 253.00
M12.0 x 1.00	1	1	11.324	11.206	\$ 121.00	2	\$ 11.00	\$ 253.00
M14.0 x 2.00	1 1/4	1 1/4	12.663	12.503	\$ 140.00	3	\$ 11.00	\$ 291.00
M14.0 x 1.50	1 1/4	1 1/4	12.994	12.854	\$ 140.00	3	\$ 11.00	\$ 291.00
M14.0 x 1.00	1 1/4	1 1/4	13.324	13.206	\$ 152.00	3	\$ 11.00	\$ 315.00
M15.0 x 1.00	1 1/4	1 1/4	14.324	14.206	\$ 140.00	3	\$ 11.00	\$ 291.00
M16.0 x 2.00	1 1/4	1 1/4	14.663	14.503	\$ 140.00	3	\$ 11.00	\$ 291.00
M16.0 x 1.50	1 1/4	1 1/4	14.994	14.854	\$ 140.00	3	\$ 11.00	\$ 291.00
M17.0 x 1.00	1 1/4	1 1/4	16.324	16.206	\$ 154.00	3	\$ 11.00	\$ 319.00
M18.0 x 2.50	1 7/8	1 1/4	16.334	16.164	\$ 154.00	3	\$ 11.00	\$ 319.00
M18.0 x 1.50	1 1/4	1 1/4	16.994	16.854	\$ 149.00	3	\$ 11.00	\$ 309.00
M20.0 x 2.50	1 7/8	1 1/4	18.334	18.164	\$ 154.00	3	\$ 11.00	\$ 319.00
M20.0 x 1.50	1 1/4	1 1/4	18.994	18.854	\$ 154.00	3	\$ 11.00	\$ 319.00
M22.0 x 2.50	2 1/8	1 1/2	20.334	20.164	\$ 218.00	4	\$ 12.00	\$ 448.00
M22.0 x 1.50	1 1/2	1 1/2	20.994	20.854	\$ 218.00	4	\$ 12.00	\$ 448.00
M24.0 x 3.00	2 1/8	1 1/2	22.003	21.803	\$ 220.00	4	\$ 12.00	\$ 452.00
M24.0 x 2.00	1 1/2	1 1/2	22.663	22.493	\$ 220.00	4	\$ 12.00	\$ 452.00
M27.0 x 3.00	1 1/8	1 1/2	25.003	24.803	\$ 234.00	4	\$ 12.00	\$ 480.00
M27.0 x 2.00	1 1/2	1 1/2	25.663	25.493	\$ 234.00	4	\$ 12.00	\$ 480.00
M30.0 x 3.50	2 3/8	1 5/8	27.674	27.462	\$ 238.00	5	\$ 13.00	\$ 489.00
M30.0 x 2.00	1 5/8	1 5/8	28.663	28.493	\$ 238.00	5	\$ 13.00	\$ 489.00
M30.0 x 1.50	1 5/8	1 5/8	28.994	28.844	\$ 238.00	5	\$ 13.00	\$ 489.00
M33.0 x 3.50	2 3/8	1 5/8	30.674	30.462	\$ 250.00	5	\$ 13.00	\$ 513.00
M33.0 x 2.00	1 5/8	1 5/8	31.663	31.493	\$ 250.00	5	\$ 13.00	\$ 513.00
M35.0 x 1.50	1 5/8	1 5/8	33.994	33.844	\$ 261.00	5	\$ 13.00	\$ 535.00
M36.0 x 4.00	2 3/8	1 5/8	33.342	33.118	\$ 270.00	5	\$ 13.00	\$ 553.00
M36.0 x 3.00	2 3/8	1 5/8	34.003	33.803	\$ 270.00	5	\$ 13.00	\$ 553.00
M36.0 x 2.00	1 5/8	1 5/8	34.663	34.493	\$ 270.00	5	\$ 13.00	\$ 553.00
M39.0 x 4.00	2 7/8	1 7/8	36.342	36.118	\$ 296.00	5 1/2	\$ 17.00	\$ 609.00
M39.0 x 3.00	2 7/8	1 7/8	37.003	36.803	\$ 296.00	5 1/2	\$ 17.00	\$ 609.00
M39.0 x 2.00	1 7/8	1 7/8	37.663	37.493	\$ 296.00	5 1/2	\$ 17.00	\$ 609.00

TAPERED PIPE THREAD GAGES



TAPER PIPE THREAD - PLUGS - WORKING GAGES								
SIZE	L-1 NPT BASIC STEP	L-1 NPTF BASIC STEP	L-3 NPTF BASIC STEP	PLAIN TAPER NPTF 6 STEP	L-1 ANPT BASIC STEP	L-3 ANPT BASIC STEP	PLAIN TAPER ANPT 6 STEP	HANDLE
1/16-27	\$ 105.00	\$ 133.00	\$ 139.00	\$ 227.00	\$ 195.00	\$ 238.00	\$ 240.00	\$ 11.00
1/8-27	\$ 82.00	\$ 107.00	\$ 112.00	\$ 227.00	\$ 195.00	\$ 182.00	\$ 240.00	\$ 11.00
1/4-18	\$ 86.00	\$ 111.00	\$ 117.00	\$ 227.00	\$ 195.00	\$ 182.00	\$ 240.00	\$ 11.00
3/8-18	\$ 94.00	\$ 133.00	\$ 141.00	\$ 227.00	\$ 182.00	\$ 182.00	\$ 240.00	\$ 11.00
1/2-14	\$ 107.00	\$ 153.00	\$ 157.00	\$ 227.00	\$ 167.00	\$ 195.00	\$ 240.00	\$ 12.00
3/4-14	\$ 122.00	\$ 167.00	\$ 178.00	\$ 242.00	\$ 178.00	\$ 195.00	\$ 253.00	\$ 12.00
1-11 1/2	\$ 135.00	\$ 185.00	\$ 196.00	\$ 261.00	\$ 202.00	\$ 238.00	\$ 276.00	\$ 13.00
1 1/4-11 1/2	\$ 152.00	\$ 208.00	\$ 208.00	\$ 277.00	\$ 210.00	\$ 238.00	\$ 292.00	\$ 13.00
1 1/2-11 1/2	\$ 171.00	\$ 236.00	\$ 236.00	\$ 305.00	\$ 236.00	\$ 238.00	\$ 317.00	\$ 13.00
2-11 1/2	\$ 209.00	\$ 281.00	\$ 281.00	\$ 423.00	\$ 281.00	\$ 281.00	\$ 442.00	\$ 13.00
2 1/2-8	\$ 250.00	\$ 442.00	\$ 442.00	\$ 647.00	\$ 442.00	\$ 442.00	\$ 680.00	\$ 17.00
3-8	\$ 299.00	\$ 500.00	\$ 500.00	\$ 701.00	\$ 500.00	\$ 500.00	\$ 737.00	\$ 17.00
3 1/2-8	\$ 448.00	N/A	N/A	N/A	N/A	N/A	N/A	\$ 18.00
4-8	\$ 499.00	N/A	N/A	N/A	N/A	N/A	N/A	\$ 18.00
5-8	\$ 696.00	N/A	N/A	N/A	N/A	N/A	N/A	\$ 18.00
6-8	\$ 829.00	N/A	N/A	N/A	N/A	N/A	N/A	\$ 18.00

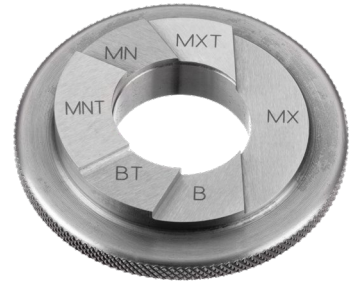
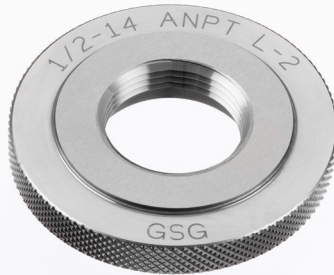

TAPER PIPE THREAD - RINGS - WORKING GAGES							
SIZE	L-1 NPT BASIC STEP	L-1 NPTF BASIC STEP	L-2 NPTF BASIC STEP	PLAIN TAPER NPTF 6 STEP	L-1 ANPT BASIC STEP	L-2 ANPT BASIC STEP	PLAIN TAPER ANPT 6 STEP
1/16-27	\$ 202.00	\$ 212.00	\$ 296.00	\$ 361.00	\$ 287.00	\$ 336.00	\$ 380.00
1/8-27	\$ 154.00	\$ 184.00	\$ 276.00	\$ 361.00	\$ 250.00	\$ 305.00	\$ 380.00
1/4-18	\$ 154.00	\$ 178.00	\$ 296.00	\$ 361.00	\$ 244.00	\$ 315.00	\$ 380.00
3/8-18	\$ 165.00	\$ 173.00	\$ 298.00	\$ 361.00	\$ 244.00	\$ 307.00	\$ 380.00
1/2-14	\$ 184.00	\$ 195.00	\$ 306.00	\$ 361.00	\$ 220.00	\$ 319.00	\$ 380.00
3/4-14	\$ 209.00	\$ 216.00	\$ 334.00	\$ 403.00	\$ 239.00	\$ 351.00	\$ 425.00
1-11 1/2	\$ 239.00	\$ 250.00	\$ 364.00	\$ 403.00	\$ 308.00	\$ 382.00	\$ 425.00
1 1/4-11 1/2	\$ 263.00	\$ 266.00	\$ 395.00	\$ 441.00	\$ 308.00	\$ 412.00	\$ 464.00
1 1/2-11 1/2	\$ 311.00	\$ 320.00	\$ 444.00	\$ 507.00	\$ 336.00	\$ 453.00	\$ 531.00
2-11 1/2	\$ 371.00	\$ 453.00	\$ 514.00	\$ 564.00	\$ 475.00	\$ 524.00	\$ 594.00
2 1/2-8	\$ 435.00	\$ 492.00	\$ 616.00	\$ 668.00	\$ 517.00	\$ 628.00	\$ 703.00
3-8	\$ 548.00	\$ 560.00	\$ 715.00	\$ 822.00	\$ 589.00	\$ 745.00	\$ 859.00
3 1/2-8	\$ 748.00	N/A	N/A	N/A	N/A	N/A	N/A
4-8	\$ 855.00	N/A	N/A	N/A	N/A	N/A	N/A
5-8	\$ 1,034.00	N/A	N/A	N/A	N/A	N/A	N/A
6-8	\$ 1,219.00	N/A	N/A	N/A	N/A	N/A	N/A

IN STOCK AS CLASS B, CONTACT FACTORY FOR CLASS A
GO PLUGS 1/8 AND SMALLER ARE TRUNCATED, ABOVE ARE FULL FORM - NOGO PLUGS ARE ALL TRUNCATED
GO RINGS 3/8 AND SMALLER ARE TRUNCATED, ABOVE ARE FULL FORM - NOGO RINGS ARE ALL TRUNCATED

BSPP THREAD GAGES								
		BSPP Plug Gage ISO 228-2 (Obsolete BS2779)	BSPP Truncated Set Plugs ISO 228-2 (Obsolete BS2779)	BSPP Progressive Check Plug ISO 228-2 (Obsolete BS2779)	Handle		BSPP Adjustable Ring Gage ISO 228-2 (Obsolete BS2779)	BSPP Solid Ring Gage ISO 228-2 (Obsolete BS2779)
Size	TPI	Price	Price	Price	#	Price	Price	Price
G1/8 GO	28	\$ 102.00	\$ 152.00	\$ 229.00	2	\$ 11.00	\$ 174.00	\$ 226.00
G1/8 NOGO	28	\$ 102.00	\$ 152.00	\$ 229.00	2	\$ 11.00	\$ 158.00	\$ 206.00
G1/4 GO	19	\$ 116.00	\$ 173.00	\$ 260.00	3	\$ 11.00	\$ 200.00	\$ 260.00
G1/4 NOGO	19	\$ 116.00	\$ 173.00	\$ 260.00	3	\$ 11.00	\$ 179.00	\$ 233.00
G3/8 GO	19	\$ 118.00	\$ 177.00	\$ 266.00	3	\$ 11.00	\$ 231.00	\$ 301.00
G3/8 NOGO	19	\$ 118.00	\$ 177.00	\$ 266.00	3	\$ 11.00	\$ 208.00	\$ 272.00
G1/2 GO	14	\$ 125.00	\$ 186.00	\$ 280.00	3	\$ 12.00	\$ 264.00	\$ 344.00
G1/2 NOGO	14	\$ 125.00	\$ 186.00	\$ 280.00	3	\$ 12.00	\$ 239.00	\$ 309.00
G5/8 GO	14	\$ 134.00	\$ 201.00	\$ 303.00	4	\$ 12.00	\$ 282.00	\$ 366.00
G5/8 NOGO	14	\$ 134.00	\$ 201.00	\$ 303.00	4	\$ 12.00	\$ 254.00	\$ 329.00
G3/4 GO	14	\$ 139.00	\$ 207.00	\$ 311.00	4	\$ 12.00	\$ 304.00	\$ 395.00
G3/4 NOGO	14	\$ 139.00	\$ 207.00	\$ 311.00	4	\$ 12.00	\$ 274.00	\$ 355.00
G7/8 GO	14	\$ 148.00	\$ 222.00	\$ 334.00	5	\$ 13.00	\$ 336.00	\$ 436.00
G7/8 NOGO	14	\$ 148.00	\$ 222.00	\$ 334.00	5	\$ 13.00	\$ 301.00	\$ 392.00
G1 GO	11	\$ 156.00	\$ 233.00	\$ 350.00	5	\$ 13.00	\$ 364.00	\$ 474.00
G1 NOGO	11	\$ 156.00	\$ 233.00	\$ 350.00	5	\$ 13.00	\$ 328.00	\$ 426.00
G1-1/8 GO	11	\$ 182.00	\$ 273.00	\$ 410.00	5	\$ 13.00	\$ 406.00	\$ 528.00
G1-1/8 NOGO	11	\$ 182.00	\$ 273.00	\$ 410.00	5	\$ 13.00	\$ 365.00	\$ 475.00
G1-1/4 GO	11	\$ 182.00	\$ 273.00	\$ 410.00	6	\$ 18.00	\$ 432.00	\$ 562.00
G1-1/4 NOGO	11	\$ 182.00	\$ 273.00	\$ 410.00	6	\$ 18.00	\$ 389.00	\$ 506.00
G1-1/2 GO	11	\$ 192.00	\$ 288.00	\$ 432.00	6	\$ 18.00	\$ 443.00	\$ 576.00
G1-1/2 NOGO	11	\$ 192.00	\$ 288.00	\$ 432.00	6	\$ 18.00	\$ 399.00	\$ 518.00
G1-3/4 GO	11	\$ 204.00	\$ 307.00	\$ 461.00	6	\$ 18.00	\$ 472.00	\$ 615.00
G1-3/4 NOGO	11	\$ 204.00	\$ 307.00	\$ 461.00	6	\$ 18.00	\$ 446.00	\$ 580.00
G2 GO	11	\$ 219.00	\$ 329.00	\$ 494.00	6	\$ 18.00	\$ 518.00	\$ 674.00
G2 NOGO	11	\$ 219.00	\$ 329.00	\$ 494.00	6	\$ 18.00	\$ 466.00	\$ 607.00
G2-1/4 GO	11	\$ 300.00	\$ 450.00	\$ 676.00	7	\$ 18.00	\$ 721.00	\$ 938.00
G2-1/4 NOGO	11	\$ 300.00	\$ 450.00	\$ 676.00	7	\$ 18.00	\$ 649.00	\$ 845.00
G2-1/2 GO	11	\$ 300.00	\$ 450.00	\$ 676.00	7	\$ 18.00	\$ 721.00	\$ 938.00
G2-1/2 NOGO	11	\$ 300.00	\$ 450.00	\$ 676.00	7	\$ 18.00	\$ 649.00	\$ 845.00
G3 GO	11	\$ 359.00	\$ 538.00	\$ 807.00	7	\$ 18.00	\$ 837.00	\$ 1,088.00
G3 NOGO	11	\$ 359.00	\$ 538.00	\$ 807.00	7	\$ 18.00	\$ 754.00	\$ 979.00
G3-1/2 GO	11	\$ 403.00	\$ 604.00	\$ 907.00	7	\$ 18.00	\$ 966.00	\$ 1,254.00
G3-1/2 NOGO	11	\$ 403.00	\$ 604.00	\$ 907.00	7	\$ 18.00	\$ 869.00	\$ 1,130.00
G4 GO	11	\$ 493.00	\$ 740.00	\$ 1,110.00	7	\$ 18.00	\$ 1,122.00	\$ 1,458.00
G4 NOGO	11	\$ 493.00	\$ 740.00	\$ 1,110.00	7	\$ 18.00	\$ 1,010.00	\$ 1,312.00
G5 GO	11	\$ 672.00	\$ 1,007.00	\$ 1,511.00	7	\$ 18.00	\$ 1,486.00	\$ 1,934.00
G5 NOGO	11	\$ 672.00	\$ 1,007.00	\$ 1,511.00	7	\$ 18.00	\$ 1,339.00	\$ 1,739.00
G6 GO	11	\$ 745.00	\$ 1,117.00	\$ 1,675.00	7	\$ 18.00	\$ 1,851.00	\$ 2,406.00
G6 NOGO	11	\$ 745.00	\$ 1,117.00	\$ 1,675.00	7	\$ 18.00	\$ 1,665.00	\$ 2,166.00

IN STOCK AS SYSTEM B, CONTACT FACTORY FOR SYSTEM A
PLUGS 1/8 AND SMALLER ARE TRUNCATED, ABOVE ARE FULL FORM
RINGS 3/8 AND SMALLER ARE TRUNCATED, ABOVE ARE FULL FORM

BSPT THREAD GAGES					
		BSPT Plug Gage BS21	Handle		BSPT Solid Ring Gage BS21
Size	TPI	Price	#	Price	Price
1/16	28	\$ 231.00	1	\$ 11.00	\$ 520.00
1/8	28	\$ 200.00	2	\$ 11.00	\$ 449.00
1/4	19	\$ 209.00	3	\$ 11.00	\$ 449.00
3/8	19	\$ 209.00	3	\$ 11.00	\$ 449.00
1/2	14	\$ 224.00	4	\$ 12.00	\$ 504.00
3/4	14	\$ 240.00	4	\$ 12.00	\$ 539.00
1	11	\$ 252.00	5	\$ 13.00	\$ 565.00
1 1/4	11	\$ 273.00	5	\$ 13.00	\$ 613.00
1 1/2	11	\$ 287.00	5	\$ 13.00	\$ 645.00
2	11	\$ 319.00	5	\$ 13.00	\$ 718.00
2 1/2	11	\$ 361.00	7	\$ 18.00	\$ 811.00
3.0	11	\$ 600.00	7	\$ 18.00	\$ 1,346.00
4	11	\$ 990.00	7	\$ 18.00	\$ 2,229.00
5	11	\$ 1,241.00	7	\$ 18.00	\$ 2,791.00
6	11	\$ 1,388.00	7	\$ 18.00	\$ 3,122.00

BSPT RINGS WITH SPECIAL MARKING ARE NON-RETURNABLE

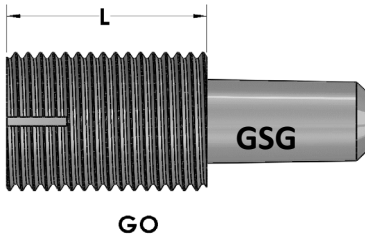

**HELICAL COIL (STI)
THREAD PLUG GAGES
STEEL**

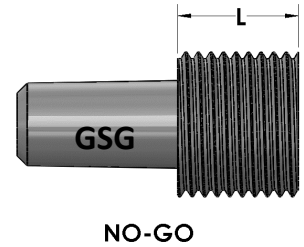

Helical Coil (STI) Plug Gages are used to gage threaded holes prior to insertion of screw thread inserts. Screw thread inserts are used to repair a damaged thread or to provide a stronger threaded assembly. All Helical Coil Plug Gages are manufactured of hardened tool steel to class X tolerance. For class W contact factory.

All stocked gages are marked in fraction. There is a \$10.00 charge per member to change the marking to decimal.

Inch									
Nominal Size	Go Length "L"	NoGo Length "L"	Go Pitch Diameter	NoGo 2B Pitch Diameter	NoGo 3B Pitch Diameter	Member List Price	Handle #	Handle Price	Double End Go/NoGo/Hdle List Price
2-56 (.086) UNC	5/16	7/32	0.0976	0.0996	0.0989	\$ 66.00	00	\$ 12.00	\$ 144.00
3-48 (.099) UNC	5/16	7/32	0.1126	0.1148	0.1140	\$ 63.00	00	\$ 12.00	\$ 138.00
3-56 (.099) UNF	5/16	7/32	0.1106	0.1126	0.1119	\$ 63.00	00	\$ 12.00	\$ 138.00
4-40 (.112) UNC	5/16	7/32	0.1283	0.1308	0.1299	\$ 59.00	00	\$ 12.00	\$ 130.00
4-48 (.112) UNF	5/16	7/32	0.1256	0.1279	0.1271	\$ 59.00	00	\$ 12.00	\$ 130.00
5-40 (.125) UNC	13/32	9/32	0.1413	0.1438	0.1430	\$ 59.00	0	\$ 12.00	\$ 130.00
6-32 (.138) UNC	13/32	9/32	0.1583	0.1611	0.1601	\$ 59.00	0	\$ 12.00	\$ 130.00
6-40 (.138) UNF	13/32	9/32	0.1543	0.1569	0.1560	\$ 59.00	0	\$ 12.00	\$ 130.00
8-32 (.164) UNC	13/32	9/32	0.1843	0.1872	0.1862	\$ 56.00	0	\$ 12.00	\$ 124.00
8-36 (.164) UNF	13/32	9/32	0.1821	0.1849	0.1840	\$ 56.00	0	\$ 12.00	\$ 124.00
10-24 (.190) UNC	1/2	5/16	0.2170	0.2203	0.2192	\$ 56.00	0	\$ 12.00	\$ 124.00
10-32 (.190) UNF	1/2	5/16	0.2103	0.2133	0.2123	\$ 56.00	0	\$ 12.00	\$ 124.00
12-24 (.216) UNC	1/2	5/16	0.2430	0.2464	0.2453	\$ 56.00	1	\$ 11.00	\$ 123.00
1/4-20 UNC	1/2	5/16	0.2825	0.2864	0.2851	\$ 54.00	1	\$ 11.00	\$ 119.00
1/4-28 UNF	1/2	5/16	0.2732	0.2765	0.2754	\$ 54.00	1	\$ 11.00	\$ 119.00
5/16-18 UNC	3/4	3/8	0.3486	0.3529	0.3515	\$ 54.00	2	\$ 11.00	\$ 119.00
5/16-24 UNF	3/4	3/8	0.3395	0.3433	0.3421	\$ 54.00	2	\$ 11.00	\$ 119.00
3/8-16 UNC	3/4	3/8	0.4156	0.4203	0.4189	\$ 56.00	2	\$ 11.00	\$ 123.00
3/8-24 UNF	3/4	3/8	0.4020	0.4059	0.4047	\$ 56.00	2	\$ 11.00	\$ 123.00
7/16-14 UNC	7/8	1/2	0.4839	0.4890	0.4875	\$ 59.00	3	\$ 11.00	\$ 129.00
7/16-20 UNF	7/8	1/2	0.4700	0.4744	0.4731	\$ 59.00	3	\$ 11.00	\$ 129.00
1/2-13 UNC	7/8	1/2	0.5499	0.5554	0.5537	\$ 63.00	3	\$ 11.00	\$ 137.00
1/2-20 UNF	7/8	1/2	0.5325	0.5371	0.5357	\$ 63.00	3	\$ 11.00	\$ 137.00
9/16-12 UNC	7/8	1/2	0.6167	0.6225	0.6208	\$ 75.00	3	\$ 11.00	\$ 161.00
9/16-18 UNF	7/8	1/2	0.5986	0.6035	0.6020	\$ 75.00	3	\$ 11.00	\$ 161.00
5/8-11 UNC	7/8	1/2	0.6841	0.6903	0.6885	\$ 75.00	3	\$ 11.00	\$ 161.00
5/8-18 UNF	7/8	1/2	0.6611	0.6661	0.6646	\$ 75.00	3	\$ 11.00	\$ 161.00
3/4-10 UNC	1	5/8	0.8149	0.8216	0.8196	\$ 79.00	4	\$ 12.00	\$ 170.00
3/4-16 UNF	1	5/8	0.7906	0.7961	0.7945	\$ 79.00	3	\$ 11.00	\$ 169.00

HOLE LOCATING PLUGS (FLEX PLUGS)

The Centerline Flex Plug is used to measure location of a tapped hole in a product part typically with a CMM. Note: Sizes #10 / M5 and smaller are solid with a tapered thread size from high to low limit (class 2B / 6H).

All stocked gages are marked in fraction. There is a \$10.00 charge per member to change the marking to decimal.



FLEX PLUGS - INCH							
Size	Price		Size	Price		Size	Price
0-80	\$ 151.00		8-32	\$ 118.00		7/16-20	\$ 111.00
1-64	\$ 143.00		8-36	\$ 124.00		1/2-13	\$ 113.00
1-72	\$ 149.00		10-24	\$ 117.00		1/2-20	\$ 117.00
2-56	\$ 139.00		10-32	\$ 118.00		9/16-12	\$ 111.00
2-64	\$ 143.00		12-24	\$ 116.00		9/16-18	\$ 117.00
3-48	\$ 133.00		12-28	\$ 117.00		5/8-11	\$ 116.00
3-56	\$ 139.00		1/4-20	\$ 100.00		5/8-18	\$ 121.00
4-40	\$ 116.00		1/4-28	\$ 102.00		3/4-10	\$ 121.00
4-48	\$ 122.00		5/16-18	\$ 100.00		3/4-16	\$ 124.00
5-40	\$ 124.00		5/16-24	\$ 102.00		7/8-9	\$ 141.00
5-44	\$ 117.00		3/8-16	\$ 110.00		7/8-14	\$ 149.00
6-32	\$ 125.00		3/8-24	\$ 111.00		1"-8	\$ 201.00
6-40	\$ 127.00		7/16-14	\$ 107.00		1"-12	\$ 201.00

FLEX PLUG - METRIC							
Size	Price		Size	Price		Size	Price
M1.6 x 0.35	\$ 164.00		M10 x 1.25	\$ 127.00		M17 x 1.0	\$ 151.00
M2 x 0.4	\$ 157.00		M10 x 0.75	\$ 171.00		M18 x 1.5	\$ 151.00
M2.5 x 0.45	\$ 157.00		M12 x 1.75	\$ 133.00		M20 x 2.5	\$ 151.00
M3 x 0.5	\$ 153.00		M12 x 1.5	\$ 133.00		M20 x 1.5	\$ 153.00
M3.5 x .6	\$ 153.00		M12 x 1.25	\$ 137.00		M20 x 1.0	\$ 153.00
M4 x 0.7	\$ 149.00		M12 x 1.0	\$ 137.00		M22 x 2.5	\$ 167.00
M5 x 0.8	\$ 137.00		M14 x 2.0	\$ 141.00		M22 x 1.5	\$ 167.00
M6 x 1.0	\$ 122.00		M14 x 1.5	\$ 141.00		M24 x 3.0	\$ 182.00
M8 x 1.25	\$ 121.00		M15 x 1.0	\$ 141.00		M24 x 2.0	\$ 182.00
M8 x 1.0	\$ 121.00		M16 x 2.0	\$ 141.00		NA	\$ -
M10 x 1.5	\$ 126.00		M16 x 1.5	\$ 149.00		NA	\$ -

AGD LIMIT SNAP GAGES

Gaging surfaces are hardened, ground & lapped tool steel. Marking discs are supplied on all snap gages.
Set & Sealed \$45.00 / Unset but Marked \$15.00

MODEL "C" STYLE 108		
FRAME #	RANGE	Price
1	0 - 1/4	\$ 169.00
2	1/4 - 1/2	\$ 171.00
2X	1/2 - 3/4	\$ 171.00
3	3/4 - 1	\$ 180.00
3X	1 - 1 1/4	\$ 180.00
4	1 1/4 - 1 1/2	\$ 183.00
4X	1 1/2 - 1 3/4	\$ 183.00
5	1 3/4 - 2	\$ 190.00
5X	2 - 2 1/4	\$ 190.00
6	2 1/4 - 2 1/2	\$ 198.00
6X	2 1/2 - 2 3/4	\$ 198.00
7	2 3/4 - 3 1/16	\$ 229.00
7X	3 1/16 - 3 7/16	\$ 229.00
8	3 7/16 - 3 13/16	\$ 248.00
8X	3 13/16 - 4 3/16	\$ 248.00
9	4 3/16 - 4 9/16	\$ 284.00
9X	4 9/16 - 4 15/16	\$ 284.00
10	4 15/16 - 5 5/16	\$ 332.00
10X	5 5/16 - 5 11/16	\$ 332.00
11	5 11/16 - 6 1/8	\$ 424.00
11X	6 1/8 - 6 5/8	\$ 424.00
12	6 5/8 - 7 1/8	\$ 484.00
12X	7 1/8 - 7 5/8	\$ 484.00
13	7 5/8 - 8 1/8	\$ 532.00
13X	8 1/8 - 8 5/8	\$ 532.00



MODEL "MC" STYLE 102		
FRAME #	RANGE	Price
00	.000 - .195	\$ 181.00
00	.195 - .385	\$ 181.00
0	.385 - .570	\$ 181.00
0	.570 - .760	\$ 181.00



MODEL "A" STYLE 104		
FRAME #	RANGE	Price
1	0 - 1/2	\$ 151.00
2	1/2 - 1	\$ 156.00
3	1 - 1 1/2	\$ 164.00
4	1 1/2 - 2	\$ 169.00
5	2 - 2 1/2	\$ 181.00
6	2 1/2 - 3	\$ 190.00
7	3 - 3 3/4	\$ 211.00
8	3 3/4 - 4 1/2	\$ 229.00
9	4 1/2 - 5 1/4	\$ 261.00
10	5 1/4 - 6	\$ 291.00



CYLINDRICAL RING GAGES

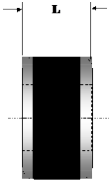

CO

All Cylindrical Ring Gages are manufactured to ASME/ANSI B47.1 AGD standard and ASME/ANSI B89.1.6

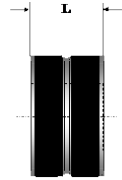

ROGO

CLASS XXX PLEASE CONTACT FACTORY
QUANTITY DISCOUNT 5 OR MORE OF IDENTICAL SIZE LESS 10%

Size	Class	Tolerance	Blank OD / Length	STEEL	CHROME	CARBIDE
				QUANTITY 1		
.015 to .025 0.381mm to 0.635mm	XX	.000020		\$ 366.00		
	X	.000040	#000	\$ 290.00		
	Y	.000070	15/16 3/32	\$ 275.00		
	Z	.0001		\$ 275.00		
.0251 to .040 0.636mm to 1.02mm	XX	.000020		\$ 327.00		
	X	.000040	#000	\$ 270.00		
	Y	.000070	15/16 3/32	\$ 253.00		
	Z	.0001		\$ 253.00		
.0401 to .070 1.021mm to 1.78mm	XX	.000020		\$ 224.00		\$ 352.00
	X	.000040	#00	\$ 184.00		\$ 293.00
	Y	.000070	15/16 3/16	\$ 181.00		\$ 277.00
	Z	.0001		\$ 181.00		\$ 269.00
.0701 to .150 1.781mm to 3.81mm	XX	.000020		\$ 197.00		\$ 334.00
	X	.000040	#00	\$ 163.00		\$ 278.00
	Y	.000070	15/16 3/16	\$ 160.00		\$ 269.00
	Z	.0001		\$ 160.00		\$ 258.00
.1501 to .230 3.811mm to 5.84mm	XX	.000020		\$ 162.00	\$ 227.00	\$ 306.00
	X	.000040	#0	\$ 135.00	\$ 189.00	\$ 255.00
	Y	.000070	15/16 3/8	\$ 127.00	\$ 177.00	\$ 238.00
	Z	.0001		\$ 127.00	\$ 177.00	\$ 229.00
.2301 to .365 5.841mm to 9.27mm	XX	.000020		\$ 143.00	\$ 200.00	\$ 273.00
	X	.000040	#1	\$ 119.00	\$ 166.00	\$ 228.00
	Y	.000070	1 1/8 9/16	\$ 113.00	\$ 159.00	\$ 216.00
	Z	.0001		\$ 113.00	\$ 159.00	\$ 206.00
.3651 to .510 9.271mm to 12.95mm	XX	.000020		\$ 144.00	\$ 201.00	\$ 284.00
	X	.000040	#2	\$ 120.00	\$ 168.00	\$ 236.00
	Y	.000070	1 3/8 3/4	\$ 112.00	\$ 157.00	\$ 226.00
	Z	.0001		\$ 112.00	\$ 157.00	\$ 216.00
.5101 to .825 12.951mm to 20.96mm	XX	.000020		\$ 153.00	\$ 214.00	\$ 333.00
	X	.000040	#3	\$ 128.00	\$ 179.00	\$ 277.00
	Y	.000070	1 3/4 15/16	\$ 118.00	\$ 165.00	\$ 263.00
	Z	.0001		\$ 118.00	\$ 165.00	\$ 255.00
.8251 to 1.135 20.961mm to 28.83mm	XX	.000030		\$ 155.00	\$ 216.00	\$ 460.00
	X	.000060	#4	\$ 129.00	\$ 180.00	\$ 383.00
	Y	.000090	2 1/8 1 1/8	\$ 120.00	\$ 168.00	\$ 362.00
	Z	.00012		\$ 120.00	\$ 168.00	\$ 354.00
1.1351 to 1.335 28.831mm to 33.91mm	XX	.000030		\$ 172.00	\$ 240.00	\$ 520.00
	X	.000060	#5	\$ 143.00	\$ 200.00	\$ 434.00
	Y	.000090	2 1/2 1 5/16	\$ 135.00	\$ 189.00	\$ 406.00
	Z	.00012		\$ 135.00	\$ 189.00	\$ 399.00
1.3351 to 1.510 33.911mm to 38.35mm	XX	.000030		\$ 172.00	\$ 240.00	\$ 564.00
	X	.000060	#5	\$ 143.00	\$ 200.00	\$ 470.00
	Y	.000090	2 1/2 1 5/16	\$ 135.00	\$ 189.00	\$ 439.00
	Z	.00012		\$ 135.00	\$ 189.00	\$ 428.00
1.5101 to 1.760 38.351mm to 44.70mm	XX	.000040		\$ 228.00	\$ 320.00	\$ 747.00
	X	.000080	#6	\$ 190.00	\$ 266.00	\$ 623.00
	Y	.00012	4 1 1/2	\$ 178.00	\$ 249.00	\$ 572.00
	Z	.00016		\$ 178.00	\$ 249.00	\$ 561.00
1.7601 to 2.010 44.701mm to 51.05mm	XX	.000040		\$ 228.00	\$ 320.00	\$ 876.00
	X	.000080	#6	\$ 190.00	\$ 266.00	\$ 730.00
	Y	.00012	4 1 1/2	\$ 178.00	\$ 249.00	\$ 691.00
	Z	.00016		\$ 178.00	\$ 249.00	\$ 679.00
2.0101 to 2.260 51.051mm to 57.40mm	XX	.000040		\$ 228.00	\$ 320.00	\$ 1,127.00
	X	.000080	#7	\$ 190.00	\$ 266.00	\$ 939.00
	Y	.00012	4 1/2 1 1/2	\$ 178.00	\$ 249.00	\$ 891.00
	Z	.00016		\$ 178.00	\$ 249.00	\$ 882.00
2.2601 to 2.510 57.401mm to 63.75mm	XX	.000040		\$ 262.00	\$ 366.00	\$ 1,048.00
	X	.000080	#7	\$ 218.00	\$ 305.00	\$ 873.00
	Y	.00012	4 1/2 1 1/2	\$ 199.00	\$ 278.00	\$ 834.00
	Z	.00016		\$ 194.00	\$ 271.00	\$ 826.00

CYLINDRICAL RING GAGES

STEEL & CHROME

Rings above 5.510 will not be supplied with tapped holes for ball handles unless requested. #7 Ball Handles available at \$60.00 each.

QUANTITY DISCOUNT 5 OR MORE OF IDENTICAL SIZE LESS 10%

Size	Class	Tolerance	Blank OD / Length	Quantity 1 price	
				STEEL	CHROME
2.5101 to 3.010 63.751mm to 76.45mm	XX	.000050	#8 5 1 1/2	\$ 306.00	\$ 429.00
	X	.0001		\$ 255.00	\$ 358.00
	Y	.00015		\$ 227.00	\$ 318.00
	Z	.0002		\$ 221.00	\$ 310.00
3.0101 to 3.510 76.451mm to 89.15mm	XX	.000050	#9 5 1/2 1 1/2	\$ 354.00	\$ 495.00
	X	.0001		\$ 295.00	\$ 413.00
	Y	.00015		\$ 260.00	\$ 363.00
	Z	.0002		\$ 260.00	\$ 363.00
3.5101 to 4.010 89.151mm to 101.85mm	XX	.000050	#10 6 3/8 1 1/2	\$ 401.00	\$ 562.00
	X	.0001		\$ 334.00	\$ 468.00
	Y	.00015		\$ 295.00	\$ 413.00
	Z	.0002		\$ 295.00	\$ 413.00
4.0101 to 4.760 101.851mm to 120.90mm	XX	.000050	#11 7 1/4 1 1/2	\$ 465.00	\$ 651.00
	X	.0001		\$ 388.00	\$ 543.00
	Y	.00015		\$ 347.00	\$ 486.00
	Z	.0002		\$ 338.00	\$ 473.00
4.7601 to 5.510 120.911mm to 139.95mm	XX	.000065	#12 8 1/4 1 1/2	\$ 606.00	\$ 848.00
	X	.00013		\$ 505.00	\$ 707.00
	Y	.00019		\$ 454.00	\$ 636.00
	Z	.00025		\$ 454.00	\$ 636.00
5.5101 to 6.260 139.951mm to 159.00mm	XX	.000065	#13 9 1/4 1 1/2	\$ 709.00	\$ 993.00
	X	.00013		\$ 591.00	\$ 827.00
	Y	.00019		\$ 521.00	\$ 730.00
	Z	.00025		\$ 521.00	\$ 730.00
6.2601 to 7.010 159.001mm to 178.05mm	XX	See chart	#14 10 1/4 1 1/2	\$ 915.00	\$ 1,281.00
	X			\$ 762.00	\$ 1,067.00
	Y			\$ 728.00	\$ 1,019.00
	Z			\$ 728.00	\$ 1,019.00
7.0101 to 7.760 178.051mm to 197.10mm	XX	.000080	#15 11 1/4 1 1/2	\$ 1,032.00	\$ 1,445.00
	X	.00016		\$ 860.00	\$ 1,205.00
	Y	.00024		\$ 823.00	\$ 1,152.00
	Z	.00032		\$ 789.00	\$ 1,104.00
7.7601 to 8.510 197.101mm to 216.15mm	XX	.000080	#16 12 1/4 1 1/2	\$ 1,166.00	\$ 1,633.00
	X	.00016		\$ 972.00	\$ 1,361.00
	Y	.00024		\$ 929.00	\$ 1,300.00
	Z	.00032		\$ 890.00	\$ 1,246.00
8.5101 to 9.260 216.151mm to 235.20mm	XX	See chart	#17 13 1/4 1 1/2	\$ 1,367.00	\$ 1,913.00
	X			\$ 1,139.00	\$ 1,594.00
	Y			\$ 1,084.00	\$ 1,517.00
	Z			\$ 997.00	\$ 1,396.00

Please contact factory for larger sizes up to 30"

CYLINDRICAL TOLERANCE CHARTS

DIAMETERS (INCH) ABOVE & INCLUDING	CLASS					
	XXX	XX	X	Y	Z	ZZ
.010" - .825"	.000010"	.000020"	.000040"	.000070"	.0001"	.0002"
.825" - 1.510"	.000015"	.000030"	.000060"	.000090"	.00012"	.00024"
1.510" - 2.510"	.000020"	.000040"	.000080"	.00012"	.00016"	.00032"
2.510" - 4.510"	.000025"	.000050"	.0001"	.00015"	.0002"	.0004"
4.510" - 6.510"	.000033"	.000065"	.00013"	.00019"	.00025"	.0005"
6.510" - 9.010"	.000040"	.000080"	.00016"	.00024"	.00032"	.00064"
9.010" - 12.010"	.000050"	.0001"	.0002"	.0003"	.0004"	.0008



MASTER SETTING DISCS STEEL & CHROME

All Cylindrical Master Discs are manufactured to ASME/ANSI B47.1 AGD standard and ASME/ANSI B89.1.5. Master Discs above 2.510in / 63.75mm are black oxidized on all non-gaging surfaces. Black anodized aluminum holders available upon request.

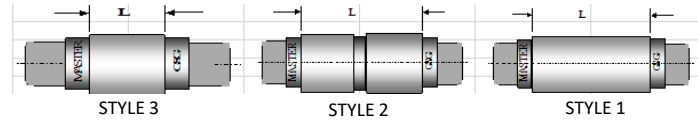
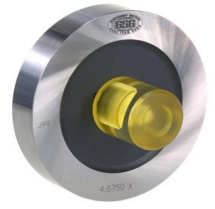

Class Z priced same as Class Y, Contact factory for XXX
Quantity discount 5 or more identical size less 10%

Size	Class	Tolerance	Length	Bilateral Tolerance		Go Minus / NoGo Plus		Bilateral Tolerance	
				STYLE 3		STYLE 2		STYLE 1	
				QUANTITY 1		QUANTITY 1		QUANTITY 1	
				STEEL	CHROME	STEEL	CHROME	STEEL	CHROME
.105 to .150 2.671mm to 3.81mm	XX	.000020	#3 3/8	\$ 110.00	\$ 164.00	\$ 209.00	\$ 314.00	\$ 126.00	\$ 189.00
	X	.000040	#2 3/4	\$ 91.00	\$ 137.00	\$ 174.00	\$ 261.00	\$ 105.00	\$ 158.00
	Y	.000070	#1 3/4	\$ 87.00	\$ 131.00	\$ 166.00	\$ 249.00	\$ 98.00	\$ 146.00
.1501 to .230 3.811mm to 5.84mm	XX	.000020	#3 7/16	\$ 110.00	\$ 164.00	\$ 209.00	\$ 314.00	\$ 126.00	\$ 189.00
	X	.000040	#2 7/8	\$ 91.00	\$ 137.00	\$ 174.00	\$ 261.00	\$ 105.00	\$ 158.00
	Y	.000070	#1 7/8	\$ 87.00	\$ 131.00	\$ 166.00	\$ 249.00	\$ 98.00	\$ 146.00
.2301 to .365 5.841mm to 9.27mm	XX	.000020	#3 1/2	\$ 111.00	\$ 166.00	\$ 210.00	\$ 316.00	\$ 127.00	\$ 191.00
	X	.000040	#2 1	\$ 92.00	\$ 139.00	\$ 175.00	\$ 263.00	\$ 106.00	\$ 159.00
	Y	.000070	#1 1	\$ 88.00	\$ 132.00	\$ 167.00	\$ 250.00	\$ 100.00	\$ 150.00
.3651 to .510 9.271mm to 12.95mm	XX	.000020	#3 9/16	\$ 111.00	\$ 166.00	\$ 214.00	\$ 321.00	\$ 129.00	\$ 193.00
	X	.000040	#2 1 1/8	\$ 92.00	\$ 139.00	\$ 179.00	\$ 268.00	\$ 107.00	\$ 161.00
	Y	.000070	#1 1 1/8	\$ 88.00	\$ 132.00	\$ 168.00	\$ 252.00	\$ 100.00	\$ 150.00
.5101 to .825 12.951mm to 20.96mm	XX	.000020	#3 5/8	\$ 112.00	\$ 168.00	\$ 215.00	\$ 323.00	\$ 129.00	\$ 193.00
	X	.000040	#2 1 1/4	\$ 93.00	\$ 140.00	\$ 180.00	\$ 269.00	\$ 107.00	\$ 161.00
	Y	.000070	#1 1 1/4	\$ 89.00	\$ 134.00	\$ 169.00	\$ 254.00	\$ 102.00	\$ 153.00
.8251 to 1.135 20.961mm to 28.83mm	XX	.000030	#3 11/16	\$ 115.00	\$ 172.00	\$ 219.00	\$ 329.00	\$ 132.00	\$ 198.00
	X	.000060	#2 1 3/8	\$ 96.00	\$ 143.00	\$ 183.00	\$ 274.00	\$ 110.00	\$ 165.00
	Y	.000090	#1 1 3/8	\$ 91.00	\$ 137.00	\$ 174.00	\$ 261.00	\$ 106.00	\$ 159.00
1.1351 to 1.510 28.831mm to 38.35mm	XX	.000030	#3 13/16	\$ 116.00	\$ 174.00	\$ 222.00	\$ 333.00	\$ 137.00	\$ 206.00
	X	.000060	#2 1 5/8	\$ 97.00	\$ 145.00	\$ 185.00	\$ 277.00	\$ 114.00	\$ 172.00
	Y	.000090	#1 1 5/8	\$ 92.00	\$ 139.00	\$ 176.00	\$ 265.00	\$ 109.00	\$ 164.00
1.5101 to 2.010 38.351mm to 51.05mm	XX	.000040	#3 7/8	\$ 156.00	\$ 234.00	\$ 300.00	\$ 449.00	\$ 173.00	\$ 251.00
	X	.000080	#2 2	\$ 130.00	\$ 195.00	\$ 250.00	\$ 375.00	\$ 140.00	\$ 210.00
	Y	.00012	#1 1 7/8	\$ 125.00	\$ 188.00	\$ 242.00	\$ 363.00	\$ 130.00	\$ 195.00
2.0101 to 2.510 51.051mm to 63.75mm	XX	.000040	#3 7/8	\$ 161.00	\$ 242.00	\$ 308.00	\$ 461.00	\$ 187.00	\$ 281.00
	X	.000080	#2 2	\$ 134.00	\$ 201.00	\$ 256.00	\$ 384.00	\$ 156.00	\$ 234.00
	Y	.00012	#1 2	\$ 128.00	\$ 191.00	\$ 245.00	\$ 368.00	\$ 149.00	\$ 223.00
2.5101 to 3.010 63.751mm to 76.45mm	XX	.000050	#3 1	\$ 194.00	\$ 291.00	\$ 372.00	\$ 558.00	\$ 212.00	\$ 305.00
	X	.0001	#2 2 1/4	\$ 162.00	\$ 243.00	\$ 310.00	\$ 465.00	\$ 169.00	\$ 254.00
	Y	.00015	#1 2	\$ 154.00	\$ 231.00	\$ 294.00	\$ 441.00	\$ 161.00	\$ 241.00
3.0101 to 3.510 76.451mm to 89.15mm	XX	.000050	#3 1	\$ 297.00	\$ 446.00	\$ 565.00	\$ 847.00	\$ 356.00	\$ 535.00
	X	.0001	#2 2 1/4	\$ 248.00	\$ 371.00	\$ 471.00	\$ 706.00	\$ 297.00	\$ 446.00
	Y	.00015	#1 2	\$ 235.00	\$ 353.00	\$ 450.00	\$ 675.00	\$ 283.00	\$ 424.00
3.5101 to 4.010 89.151mm to 101.85mm	XX	.000050	#3 1	\$ 300.00	\$ 449.00	\$ 576.00	\$ 863.00	\$ 381.00	\$ 572.00
	X	.0001	#2 2 1/4	\$ 250.00	\$ 375.00	\$ 480.00	\$ 719.00	\$ 318.00	\$ 477.00
	Y	.00015	#1 2 1/8	\$ 242.00	\$ 363.00	\$ 454.00	\$ 681.00	\$ 305.00	\$ 457.00
4.0101 to 4.510 101.851mm to 114.55mm	XX	.000050	#3 1	\$ 336.00	\$ 503.00	\$ 635.00	\$ 953.00	\$ 431.00	\$ 646.00
	X	.0001	#2 2 1/4	\$ 280.00	\$ 419.00	\$ 529.00	\$ 794.00	\$ 359.00	\$ 538.00
	Y	.00015	#1 2 1/8	\$ 268.00	\$ 401.00	\$ 506.00	\$ 760.00	\$ 340.00	\$ 509.00
4.5101 to 5.010 114.551mm to 127.25mm	XX	.000065	#3 1	\$ 354.00	\$ 531.00	\$ 668.00	\$ 1,002.00	\$ 534.00	\$ 801.00
	X	.00013	#2 2 1/4	\$ 295.00	\$ 443.00	\$ 557.00	\$ 835.00	\$ 445.00	\$ 668.00
	Y	.00019	#1 2 1/8	\$ 280.00	\$ 419.00	\$ 528.00	\$ 792.00	\$ 426.00	\$ 639.00
5.0101 to 5.510 127.251mm to 139.95mm	XX	.000065	#3 1	\$ 359.00	\$ 538.00	\$ 683.00	\$ 1,024.00	\$ 552.00	\$ 827.00
	X	.00013	#2 2 1/4	\$ 299.00	\$ 448.00	\$ 569.00	\$ 853.00	\$ 460.00	\$ 689.00
	Y	.00019	#1 2 1/8	\$ 286.00	\$ 428.00	\$ 541.00	\$ 812.00	\$ 436.00	\$ 653.00
5.5101 to 6.010 139.951mm to 152.65mm	XX	.000065	#3 1	\$ 364.00	\$ 546.00	\$ 691.00	\$ 1,037.00	\$ 566.00	\$ 849.00
	X	.00013	#2 2 1/4	\$ 304.00	\$ 455.00	\$ 576.00	\$ 864.00	\$ 472.00	\$ 707.00
	Y	.00019	#1 2 1/8	\$ 290.00	\$ 436.00	\$ 552.00	\$ 828.00	\$ 448.00	\$ 671.00

MASTER SETTING DISCS - CON'T
STEEL & CHROME



Quantity (5) or more of same size less 10%
CLASS Z PRICED SAME AS Y CLASS

Size	Class	Tolerance	Length	Bilateral Tolerance		Go Minus / NoGo Plus		Bilateral Tolerance	
				STYLE 3		STYLE 2		STYLE 1	
				QUANTITY 1		QUANTITY 1		QUANTITY 1	
				STEEL	CHROME	STEEL	CHROME	STEEL	CHROME
6.010 to 6.510 152.651mm to 165.35mm	XX	.000065	#3 1	\$ 414.00	\$ 622.00	\$ 854.00	\$ 1,198.00	\$ 624.00	\$ 857.00
	X	.00013	#2 2 1/4	\$ 330.00	\$ 496.00	\$ 712.00	\$ 1,068.00	\$ 520.00	\$ 780.00
	Y	.00019	#1 2 1/8	\$ 316.00	\$ 474.00	\$ 676.00	\$ 1,014.00	\$ 496.00	\$ 744.00
6.5101 to 7.010 165.351mm to 178.05mm	XX	.000080	#3 1	\$ 564.00	\$ 781.00	\$ 1,080.00	\$ 1,486.00	\$ 967.00	\$ 1,331.00
	X	.00016	#2 2 1/4	\$ 470.00	\$ 706.00	\$ 900.00	\$ 1,350.00	\$ 806.00	\$ 1,210.00
	Y	.00024	#1 2 1/8	\$ 451.00	\$ 677.00	\$ 853.00	\$ 1,280.00	\$ 767.00	\$ 1,151.00
7.0101 to 7.510 178.051mm to 190.75mm	XX	.000080	#3 1	\$ 581.00	\$ 798.00	\$ 1,099.00	\$ 1,514.00	\$ 986.00	\$ 1,364.00
	X	.00016	#2 2 1/4	\$ 484.00	\$ 726.00	\$ 916.00	\$ 1,374.00	\$ 822.00	\$ 1,234.00
	Y	.00024	#1 2 1/8	\$ 458.00	\$ 688.00	\$ 872.00	\$ 1,309.00	\$ 784.00	\$ 1,176.00
7.5101 to 8.010 190.751mm to 203.45mm	XX	.000080	#3 1	\$ 590.00	\$ 814.00	\$ 1,122.00	\$ 1,543.00	\$ 1,032.00	\$ 1,426.00
	X	.00016	#2 2 1/4	\$ 492.00	\$ 738.00	\$ 935.00	\$ 1,403.00	\$ 860.00	\$ 1,291.00
	Y	.00024	#1 2 1/8	\$ 467.00	\$ 701.00	\$ 888.00	\$ 1,332.00	\$ 821.00	\$ 1,231.00

Contact Factory for pricing on sizes 8.010 to 36.00" Style #3
Discs above 8.010 will be trilock design, not annular

CARBIDE

Size	Class	Tolerance	STYLE 3		STYLE 2		STYLE 1	
			Length	Qty 1	Length	Qty 1	Length	Qty 1
.150 to .185 3.810mm to 4.70mm	XX	.000020		\$ 180.00		\$ 312.00		\$ 192.00
	X	.000040	7/16	\$ 150.00	7/8	\$ 260.00	7/8	\$ 160.00
	Y	.00007		\$ 143.00		\$ 247.00		\$ 152.00
	Z	.0001		\$ 135.00		\$ 230.00		\$ 144.00
.1851 to .230 4.701mm to 5.84mm	XX	.00002		\$ 180.00		\$ 312.00		\$ 192.00
	X	.000040	7/16	\$ 150.00	7/8	\$ 260.00	7/8	\$ 160.00
	Y	.000070		\$ 143.00		\$ 247.00		\$ 152.00
	Z	.0001		\$ 135.00		\$ 230.00		\$ 144.00
.2301 to .281 5.841mm to 7.14mm	XX	.000020		\$ 184.00		\$ 318.00		\$ 198.00
	X	.000040	1/2	\$ 153.00	1	\$ 265.00	1	\$ 165.00
	Y	.000070		\$ 145.00		\$ 251.00		\$ 156.00
	Z	.0001		\$ 138.00		\$ 239.00		\$ 148.00
.2811 to .365 7.141mm to 9.27mm	XX	.000020		\$ 184.00		\$ 318.00		\$ 198.00
	X	.000040	1/2	\$ 153.00	1	\$ 265.00	1	\$ 165.00
	Y	.000070		\$ 145.00		\$ 251.00		\$ 156.00
	Z	.0001		\$ 138.00		\$ 239.00		\$ 148.00
.3651 to .469 9.271mm to 11.91mm	XX	.000020		\$ 202.00		\$ 368.00		\$ 222.00
	X	.000040	9/16	\$ 168.00	1 1/8	\$ 307.00	1 1/8	\$ 185.00
	Y	.000070		\$ 161.00		\$ 300.00		\$ 175.00
	Z	.000070		\$ 154.00		\$ 293.00		\$ 166.00
.4691 to .510 11.911mm to 12.95mm	XX	.000020		\$ 222.00		\$ 402.00		\$ 222.00
	X	.000040	9/16	\$ 185.00	1 1/8	\$ 335.00	1 1/8	\$ 185.00
	Y	.000070		\$ 182.00		\$ 333.00		\$ 175.00
	Z	.0001		\$ 172.00		\$ 327.00		\$ 166.00
.5101 to .563 12.951mm to 14.30mm	XX	.000020		\$ 235.00		\$ 426.00		\$ 240.00
	X	.000040	5/8	\$ 196.00	1 1/4	\$ 355.00	1 1/4	\$ 200.00
	Y	.000070		\$ 191.00		\$ 352.00		\$ 196.00
	Z	.000070		\$ 183.00		\$ 347.00		\$ 186.00
.5631 to .625 14.301mm to 15.87mm	XX	.000020		\$ 247.00		\$ 443.00		\$ 254.00
	X	.000040	5/8	\$ 206.00	1 1/4	\$ 369.00	1 1/4	\$ 212.00
	Y	.000070		\$ 197.00		\$ 365.00		\$ 206.00
	Z	.0001		\$ 190.00		\$ 359.00		\$ 197.00
.6251 to .656 15.871mm to 16.66mm	XX	.000020		\$ 258.00		\$ 456.00		\$ 266.00
	X	.000040	5/8	\$ 215.00	1 1/4	\$ 380.00	1 1/4	\$ 222.00
	Y	.000070		\$ 211.00		\$ 375.00		\$ 215.00
	Z	.000070		\$ 203.00		\$ 369.00		\$ 206.00
.6561 to .7180 16.661mm to 18.23mm	XX	.000020		\$ 270.00		\$ 496.00		\$ 276.00
	X	.000040	5/8	\$ 225.00	1 1/4	\$ 413.00	1 1/4	\$ 230.00
	Y	.000070		\$ 218.00		\$ 405.00		\$ 226.00
	Z	.0001		\$ 207.00		\$ 401.00		\$ 218.00
.7181 to .750 18.231mm to 19.05mm	XX	.000020		\$ 281.00		\$ 530.00		\$ 293.00
	X	.000040	5/8	\$ 234.00	1 1/4	\$ 442.00	1 1/4	\$ 244.00
	Y	.000070		\$ 229.00		\$ 439.00		\$ 235.00
	Z	.000070		\$ 221.00		\$ 433.00		\$ 228.00
.7501 to .781 19.051mm to 19.83mm	XX	.000020		\$ 324.00		\$ 547.00		\$ 334.00
	X	.000040	5/8	\$ 270.00	1 1/4	\$ 456.00	1 1/4	\$ 278.00
	Y	.000070		\$ 265.00		\$ 454.00		\$ 273.00
	Z	.0001		\$ 257.00		\$ 446.00		\$ 265.00
.7811 to .825 19.831mm to 20.96mm	XX	.000020		\$ 336.00		\$ 550.00		\$ 344.00
	X	.000040	5/8	\$ 280.00	1 1/4	\$ 458.00	1 1/4	\$ 287.00
	Y	.000070		\$ 274.00		\$ 456.00		\$ 285.00
	Z	.000070		\$ 272.00		\$ 448.00		\$ 274.00
.8251 to .875 20.961mm to 22.22mm	XX	.000030		\$ 396.00		\$ 582.00		\$ 385.00
	X	.000060	11/16	\$ 330.00	1 3/8	\$ 485.00	1 3/8	\$ 321.00
	Y	.000090		\$ 327.00		\$ 477.00		\$ 316.00
	Z	.000012		\$ 318.00		\$ 476.00		\$ 309.00

REVERSIBLE CYLINDRICAL PLUG GAGES

STEEL & CHROME

XXX Available in Carbide Only
Contact Factory

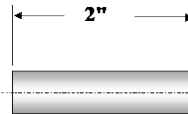

QUANTITY DISCOUNT 5 OR MORE OF IDENTICAL SIZE LESS 10%

Size	Class	Tol	QUANTITY 1		Handle #	Handle Price
			STEEL	CHROME		
.025 to .075 0.763mm to 1.91mm	XX	.000020	\$ 39.00	\$ -	1 WDE	\$ 13.00
	X	.000040	\$ 26.00	\$ -	1 WDE	\$ 13.00
	Y	.000070	\$ 24.00	\$ -	1 WDE	\$ 13.00
	Z	.0001	\$ 21.00	\$ -	1 WDE	\$ 13.00
.0751 to .180 1.911mm to 4.57mm	XX	.000020	\$ 41.00	\$ 61.00	2 WDE	\$ 13.00
	X	.000040	\$ 32.00	\$ 41.00	2 WDE	\$ 13.00
	Y	.000070	\$ 30.00	\$ 39.00	2 WDE	\$ 13.00
	Z	.0001	\$ 24.00	\$ 31.00	2 WDE	\$ 13.00
.1801 to .281 4.571mm to 7.14mm	XX	.000020	\$ 42.00	\$ 63.00	3 WDE	\$ 14.00
	X	.000040	\$ 32.00	\$ 41.00	3 WDE	\$ 14.00
	Y	.000070	\$ 30.00	\$ 39.00	3 WDE	\$ 14.00
	Z	.0001	\$ 25.00	\$ 33.00	3 WDE	\$ 14.00
.2811 to .406 7.141mm to 10.31mm	XX	.000020	\$ 46.00	\$ 69.00	4 WDE	\$ 15.00
	X	.000040	\$ 35.00	\$ 46.00	4 WDE	\$ 15.00
	Y	.000070	\$ 33.00	\$ 43.00	4 WDE	\$ 15.00
	Z	.0001	\$ 25.00	\$ 33.00	4 WDE	\$ 15.00
.4061 to .510 10.311mm to 12.95mm	XX	.000020	\$ 48.00	\$ 73.00	5 WDE	\$ 15.00
	X	.000040	\$ 36.00	\$ 47.00	5 WDE	\$ 15.00
	Y	.000070	\$ 34.00	\$ 44.00	5 WDE	\$ 15.00
	Z	.0001	\$ 29.00	\$ 37.00	5 WDE	\$ 15.00
.5101 to .635 12.951mm to 16.13mm	XX	.000020	\$ 53.00	\$ 79.00	6 WDE	\$ 16.00
	X	.000040	\$ 37.00	\$ 49.00	6 WDE	\$ 16.00
	Y	.000070	\$ 36.00	\$ 47.00	6 WDE	\$ 16.00
	Z	.0001	\$ 30.00	\$ 39.00	6 WDE	\$ 16.00
.6351 to .760 16.131mm to 19.30mm	XX	.000020	\$ 55.00	\$ 83.00	7 WDE	\$ 16.00
	X	.000040	\$ 42.00	\$ 54.00	7 WDE	\$ 16.00
	Y	.000070	\$ 37.00	\$ 49.00	7 WDE	\$ 16.00
	Z	.0001	\$ 32.00	\$ 41.00	7 WDE	\$ 16.00
.7601 to 1.010 19.301mm to 25.65mm	XX		\$ 89.00	\$ 134.00	8 WDE	\$ 24.00
	X	See	\$ 66.00	\$ 86.00	8 WDE	\$ 24.00
	Y	Chart	\$ 59.00	\$ 77.00	8 WDE	\$ 24.00
	Z		\$ 54.00	\$ 70.00	8 WDE	\$ 24.00

DEPTH STEPS FOR STEEL & CHROME REVERSIBLES, TAPERLOCKS & TRILOCKS

Depth steps above .125 inch / 3.175 mm diameter only. Extra length members 2 to 4 inches add 50%, 4 to 6 inches add 100%

Each Member

Tolerance	1 Step	2 Steps	4 Steps
0.005 (.127mm)	\$ 35.00	\$ 70.00	\$ 120.00
0.002 (.051mm)	\$ 70.00	\$ 120.00	\$ 180.00
0.001 (.025mm)	\$ 120.00	\$ 180.00	\$ 230.00

AIR GROOVES FOR STEEL & CHROME REVERSIBLES, TAPERLOCKS & TRILOCKS

Add \$ 30.00 for the first member and \$ 20.00 for additional members on same order. Extra length members 2 to 4 inches add 50%, 4 to 6 inches add 100%.

EXTRA LENGTH MEMBER PRICING STEEL & CARBIDE

Extra length members up to max 6" length above .075" price x length in even increments of one inch. Extra length steel members below .075" see page 27.

REVERSIBLE CYLINDRICAL PLUG GAGES

CARBIDE

EXTRA LENGTH MEMBERS ON PAGE 27

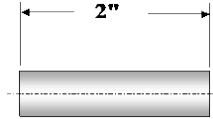

QUANTITY DISCOUNT 5 OR MORE OF IDENTICAL SIZE LESS 10%
FOR CLASS XXX IN SIZES .0350" - 1.0000" CONTACT FACTORY

Size	Class	Tol	Member Length	QUANTITY 1	Handle #	Handle Price
.040 to .075 1.021mm to 1.91mm	XX	.000020		\$ 98.00	1 WDE	\$ 13.00
	X	.000040	2 inch	\$ 90.00	1 WDE	\$ 13.00
	Y	.000070	50.8 mm	\$ 84.00	1 WDE	\$ 13.00
	Z	.0001		\$ 79.00	1 WDE	\$ 13.00
.0751 to .115 1.911mm to 2.92mm	XX	.000020		\$ 70.00	2 WDE	\$ 13.00
	X	.000040	2 inch	\$ 61.00	2 WDE	\$ 13.00
	Y	.000070	50.8 mm	\$ 57.00	2 WDE	\$ 13.00
	Z	.0001		\$ 54.00	2 WDE	\$ 13.00
.1151 to .130 2.921mm to 3.30mm	XX	.000020		\$ 72.00	2 WDE	\$ 13.00
	X	.000040	2 inch	\$ 65.00	2 WDE	\$ 13.00
	Y	.000070	50.8 mm	\$ 63.00	2 WDE	\$ 13.00
	Z	.0001		\$ 58.00	2 WDE	\$ 13.00
.1301 to .180 3.301mm to 4.57mm	XX	.000020		\$ 75.00	2 WDE	\$ 13.00
	X	.000040	2 inch	\$ 67.00	2 WDE	\$ 13.00
	Y	.000070	50.8 mm	\$ 63.00	2 WDE	\$ 13.00
	Z	.0001		\$ 59.00	2 WDE	\$ 13.00
.1801 to .230 4.571mm to 5.84mm	XX	.000020		\$ 79.00	3 WDE	\$ 14.00
	X	.000040	2 inch	\$ 70.00	3 WDE	\$ 14.00
	Y	.000070	50.8 mm	\$ 67.00	3 WDE	\$ 14.00
	Z	.0001		\$ 63.00	3 WDE	\$ 14.00
.2301 to .281 5.841mm to 7.14mm	XX	.000020		\$ 85.00	3 WDE	\$ 14.00
	X	.000040	2 inch	\$ 79.00	3 WDE	\$ 14.00
	Y	.000070	50.8 mm	\$ 77.00	3 WDE	\$ 14.00
	Z	.0001		\$ 71.00	3 WDE	\$ 14.00
.2811 to .344 7.141mm to 8.74mm	XX	.000020		\$ 90.00	4 WDE	\$ 15.00
	X	.000040	2 inch	\$ 84.00	4 WDE	\$ 15.00
	Y	.000070	50.8 mm	\$ 82.00	4 WDE	\$ 15.00
	Z	.0001		\$ 77.00	4 WDE	\$ 15.00
.3441 to .406 8.741mm to 10.31mm	XX	.000020		\$ 97.00	4 WDE	\$ 15.00
	X	.000040	2 inch	\$ 91.00	4 WDE	\$ 15.00
	Y	.000070	50.8 mm	\$ 88.00	4 WDE	\$ 15.00
	Z	.0001		\$ 84.00	4 WDE	\$ 15.00
.4061 to .460 10.311mm to 11.68mm	XX	.000020		\$ 107.00	5 WDE	\$ 15.00
	X	.000040	2 inch	\$ 100.00	5 WDE	\$ 15.00
	Y	.000070	50.8 mm	\$ 98.00	5 WDE	\$ 15.00
	Z	.0001		\$ 96.00	5 WDE	\$ 15.00
.4601 to .510 11.681mm to 12.95mm	XX	.000020		\$ 114.00	5 WDE	\$ 15.00
	X	.000040	2 inch	\$ 110.00	5 WDE	\$ 15.00
	Y	.000070	50.8 mm	\$ 106.00	5 WDE	\$ 15.00
	Z	.0001		\$ 103.00	5 WDE	\$ 15.00
.5101 to .560 12.951mm to 14.22mm	XX	.000020		\$ 149.00	6 WDE	\$ 16.00
	X	.000040	2 inch	\$ 139.00	6 WDE	\$ 16.00
	Y	.000070	50.8 mm	\$ 134.00	6 WDE	\$ 16.00
	Z	.0001		\$ 132.00	6 WDE	\$ 16.00
.5601 to .635 14.221mm to 16.13mm	XX	.000020		\$ 164.00	6 WDE	\$ 16.00
	X	.000040	2 inch	\$ 155.00	6 WDE	\$ 16.00
	Y	.000070	50.8 mm	\$ 152.00	6 WDE	\$ 16.00
	Z	.0001		\$ 147.00	6 WDE	\$ 16.00
.6351 to .700 16.131mm to 17.78mm	XX	.000020		\$ 189.00	7 WDE	\$ 16.00
	X	.000040	2 inch	\$ 184.00	7 WDE	\$ 16.00
	Y	.000070	50.8 mm	\$ 177.00	7 WDE	\$ 16.00
	Z	.0001		\$ 170.00	7 WDE	\$ 16.00
.7001 to .760 17.781mm to 19.30mm	XX	.000020		\$ 227.00	7 WDE	\$ 16.00
	X	.000040	2 inch	\$ 215.00	7 WDE	\$ 16.00
	Y	.000070	50.8 mm	\$ 211.00	7 WDE	\$ 16.00
	Z	.0001		\$ 205.00	7 WDE	\$ 16.00

DEPTH STEPS FOR CARBIDE REVERSIBLES, TAPERLOCKS & TRILOCKS

Extra length members 2 to 4" add 50%, 4 to 6" add 100%

Tolerance	Each Member		
	1 Step	2 Steps	4 Steps
0.005 (.127mm)	\$ 55.00	\$ 95.00	\$ 175.00
0.002 (.051mm)	\$ 75.00	\$ 125.00	\$ 230.00
0.001 (.025mm)	\$ 120.00	\$ 180.00	\$ 325.00

AIR FLATS FOR CARBIDE REVERSIBLES, TAPERLOCKS & TRILOCKS

Add \$ 40.00 for the first member and \$ 30.00 for additional members on same order.

REVERSIBLE CYLINDRICAL PLUG GAGES

EXTRA LENGTH

For extra length members: Roundness not to exceed 50% of gage makers size tolerance. Taper not to exceed the total gage makers tolerance. Straightness to be calculated as tolerance multiplied by length in inches (not to exceed .0002").

FOR XXX PRICING CALL FACTORY - XXX NOT AVAILABLE WITH STEEL OR CHROME
QUANTITY DISCOUNT 5 OR MORE OF IDENTICAL SIZE LESS 10%

STEEL								
Size	Class	Tol	Length "L"				Handle #	Handle Price
			3"	4"	5"	6"		
.050 to .060 763mm to 1.52mm	XX	.000020	\$ 154.00	\$ 213.00	\$ 391.00	\$ 506.00	1 WDE	\$ 13.00
	X	.000040	\$ 128.00	\$ 174.00	\$ 326.00	\$ 422.00	1 WDE	\$ 13.00
	Y	.000070	\$ 118.00	\$ 163.00	\$ 315.00	\$ 417.00	1 WDE	\$ 13.00
	Z	.0001	\$ 114.00	\$ 160.00	\$ 290.00	\$ 389.00	1 WDE	\$ 13.00
.0601 to .075 1.521mm to 1.90mm	XX	.000020	\$ 110.00	\$ 151.00	\$ 187.00	\$ 226.00	1 WDE	\$ 13.00
	X	.000040	\$ 87.00	\$ 118.00	\$ 156.00	\$ 187.00	1 WDE	\$ 13.00
	Y	.000070	\$ 77.00	\$ 112.00	\$ 155.00	\$ 184.00	1 WDE	\$ 13.00
	Z	.0001	\$ 68.00	\$ 100.00	\$ 140.00	\$ 162.00	1 WDE	\$ 13.00
.0751 to 1.010 1.901mm to 25.65mm	Price times length in even increments of one inch. See page 25.							

FOR XXX PRICING CALL FACTORY - XXX NOT AVAILABLE WITH STEEL OR CHROME
SIZES .760" - 1.00" CONTACT FACTORY
QUANTITY DISCOUNT 5 OR MORE OF IDENTICAL SIZE LESS 10%

CARBIDE								
Size	Class	Tol	Length "L"				Handle #	Handle Price
			3"	4"	5"	6"		
.115 to .180 2.921mm to 4.57mm	XX	.000020	\$ 203.00	\$ 295.00			2 WDE	\$ 13.00
	X	.000040	\$ 169.00	\$ 246.00			2 WDE	\$ 13.00
	Y	.000070	\$ 162.00	\$ 236.00			2 WDE	\$ 13.00
	Z	.0001	\$ 153.00	\$ 227.00			2 WDE	\$ 13.00
.1801 to .230 4.571mm to 5.84mm	XX	.000020	\$ 154.00	\$ 228.00	\$ 284.00	\$ 360.00	3 WDE	\$ 14.00
	X	.000040	\$ 128.00	\$ 190.00	\$ 237.00	\$ 300.00	3 WDE	\$ 14.00
	Y	.000070	\$ 124.00	\$ 183.00	\$ 232.00	\$ 288.00	3 WDE	\$ 14.00
	Z	.0001	\$ 114.00	\$ 173.00	\$ 222.00	\$ 279.00	3 WDE	\$ 14.00
.2301 to .281 5.841mm to 7.14mm	XX	.000020	\$ 172.00	\$ 250.00	\$ 394.00	\$ 496.00	3 WDE	\$ 14.00
	X	.000040	\$ 143.00	\$ 208.00	\$ 329.00	\$ 413.00	3 WDE	\$ 14.00
	Y	.000070	\$ 134.00	\$ 202.00	\$ 319.00	\$ 403.00	3 WDE	\$ 14.00
	Z	.0001	\$ 128.00	\$ 190.00	\$ 308.00	\$ 366.00	3 WDE	\$ 14.00
.2811 to .344 7.141mm to 8.74mm	XX	.000020	\$ 212.00	\$ 307.00	\$ 414.00	\$ 518.00	4 WDE	\$ 15.00
	X	.000040	\$ 177.00	\$ 256.00	\$ 345.00	\$ 432.00	4 WDE	\$ 15.00
	Y	.000070	\$ 169.00	\$ 246.00	\$ 337.00	\$ 422.00	4 WDE	\$ 15.00
	Z	.0001	\$ 162.00	\$ 237.00	\$ 330.00	\$ 384.00	4 WDE	\$ 15.00
.3441 to .406 8.741mm to 10.31mm	XX	.000020	\$ 228.00	\$ 350.00	\$ 439.00	\$ 546.00	4 WDE	\$ 15.00
	X	.000040	\$ 190.00	\$ 292.00	\$ 366.00	\$ 455.00	4 WDE	\$ 15.00
	Y	.000070	\$ 183.00	\$ 282.00	\$ 356.00	\$ 447.00	4 WDE	\$ 15.00
	Z	.0001	\$ 173.00	\$ 273.00	\$ 345.00	\$ 437.00	4 WDE	\$ 15.00
.4061 to .460 10.311mm to 11.68mm	XX	.000020	\$ 235.00	\$ 359.00	\$ 461.00	\$ 570.00	5 WDE	\$ 15.00
	X	.000040	\$ 196.00	\$ 299.00	\$ 384.00	\$ 475.00	5 WDE	\$ 15.00
	Y	.000070	\$ 187.00	\$ 292.00	\$ 373.00	\$ 466.00	5 WDE	\$ 15.00
	Z	.0001	\$ 181.00	\$ 282.00	\$ 366.00	\$ 468.00	5 WDE	\$ 15.00
.4601 to .510 11.681mm to 12.95mm	XX	.000020	\$ 250.00	\$ 380.00	\$ 480.00	\$ 599.00	5 WDE	\$ 15.00
	X	.000040	\$ 208.00	\$ 317.00	\$ 400.00	\$ 499.00	5 WDE	\$ 15.00
	Y	.000070	\$ 201.00	\$ 308.00	\$ 391.00	\$ 491.00	5 WDE	\$ 15.00
	Z	.0001	\$ 190.00	\$ 299.00	\$ 383.00	\$ 482.00	5 WDE	\$ 15.00
.5101 to .560 12.951mm to 14.22mm	XX	.000020	\$ 295.00	\$ 448.00	\$ 578.00	\$ 708.00	6 WDE	\$ 16.00
	X	.000040	\$ 246.00	\$ 373.00	\$ 482.00	\$ 590.00	6 WDE	\$ 16.00
	Y	.000070	\$ 236.00	\$ 366.00	\$ 475.00	\$ 584.00	6 WDE	\$ 16.00
	Z	.0001	\$ 227.00	\$ 356.00	\$ 466.00	\$ 573.00	6 WDE	\$ 16.00
.5601 to .635 14.221mm to 16.13mm	XX	.000020	\$ 328.00	\$ 464.00	\$ 670.00	\$ 784.00	6 WDE	\$ 16.00
	X	.000040	\$ 273.00	\$ 387.00	\$ 558.00	\$ 653.00	6 WDE	\$ 16.00
	Y	.000070	\$ 265.00	\$ 382.00	\$ 547.00	\$ 643.00	6 WDE	\$ 16.00
	Z	.0001	\$ 256.00	\$ 371.00	\$ 537.00	\$ 632.00	6 WDE	\$ 16.00
.6351 to .700 16.131mm to 17.78mm	XX	.000020	\$ 444.00	\$ 604.00	\$ 821.00	\$ 1,038.00	7 WDE	\$ 16.00
	X	.000040	\$ 370.00	\$ 503.00	\$ 684.00	\$ 865.00	7 WDE	\$ 16.00
	Y	.000070	\$ 356.00	\$ 483.00	\$ 674.00	\$ 854.00	7 WDE	\$ 16.00
	Z	.0001	\$ 345.00	\$ 471.00	\$ 665.00	\$ 845.00	7 WDE	\$ 16.00
.7001 to .760 17.781mm to 19.30mm	XX	.000020	\$ 464.00	\$ 625.00	\$ 854.00	\$ 1,070.00	7 WDE	\$ 16.00
	X	.000040	\$ 387.00	\$ 521.00	\$ 712.00	\$ 891.00	7 WDE	\$ 16.00
	Y	.000070	\$ 380.00	\$ 508.00	\$ 701.00	\$ 882.00	7 WDE	\$ 16.00
	Z	.0001	\$ 366.00	\$ 491.00	\$ 689.00	\$ 874.00	7 WDE	\$ 16.00

TAPERLOCK CYLINDRICAL PLUG GAGES

STEEL

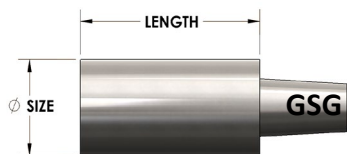

GO

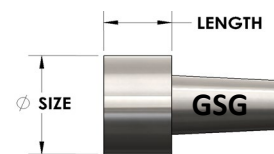

NO-GO

All Cylindrical Taperlock plug gages are manufactured to ASME/ANSI B47.1 AGD standard and ASME/ANSI B89.1.5 standard. Gaging surface is hardened to Rc 60-62.

Depth steps for steel & chrome reversible taperlocks and tri-locks available

QUANTITY DISCOUNT 5 OR MORE OF IDENTICAL SIZE LESS 10%

CHROME add 50%

Size	Class	Tolerance	Length	QUANTITY 1		Handle #	Handle Price
				Go	Nogo		
.1051 to .150 2.671mm to 3.81mm	XX	.000020	Go 3/8	\$ 74.00	\$ 73.00	00	\$ 12.00
	X	.000040	NoGo 7/32	\$ 56.00	\$ 55.00	00	\$ 12.00
	Y	.000070		\$ 54.00	\$ 54.00	00	\$ 12.00
	Z	.0001		\$ 54.00	\$ 54.00	00	\$ 12.00
.1501 to .230 3.811mm to 5.84mm	XX	.000020	Go 13/32	\$ 74.00	\$ 73.00	0	\$ 12.00
	X	.000040	NoGo 9/32	\$ 56.00	\$ 55.00	0	\$ 12.00
	Y	.000070		\$ 55.00	\$ 54.00	0	\$ 12.00
	Z	.0001		\$ 55.00	\$ 54.00	0	\$ 12.00
.2301 to .365 5.841mm to 9.27mm	XX	.000020	Go 3/4	\$ 74.00	\$ 73.00	1	\$ 11.00
	X	.000040	NoGo 5/16	\$ 56.00	\$ 56.00	1	\$ 11.00
	Y	.000070		\$ 55.00	\$ 54.00	1	\$ 11.00
	Z	.0001		\$ 55.00	\$ 54.00	1	\$ 11.00
.3651 to .510 9.271mm to 12.95mm	XX	.000020	Go 1	\$ 77.00	\$ 74.00	2	\$ 11.00
	X	.000040	NoGo 3/8	\$ 57.00	\$ 57.00	2	\$ 11.00
	Y	.000070		\$ 55.00	\$ 55.00	2	\$ 11.00
	Z	.0001		\$ 55.00	\$ 55.00	2	\$ 11.00
.5101 to .825 12.951mm to 20.96mm	XX	.000020	Go 1 1/4	\$ 81.00	\$ 80.00	3	\$ 11.00
	X	.000040	NoGo 1/2	\$ 65.00	\$ 63.00	3	\$ 11.00
	Y	.000070		\$ 61.00	\$ 57.00	3	\$ 11.00
	Z	.0001		\$ 61.00	\$ 57.00	3	\$ 11.00
.8251 to 1.135 20.961mm to 28.83mm	XX	.000030	Go 1 1/2	\$ 85.00	\$ 83.00	4	\$ 12.00
	X	.000060	NoGo 5/8	\$ 67.00	\$ 65.00	4	\$ 12.00
	Y	.000090		\$ 63.00	\$ 61.00	4	\$ 12.00
	Z	.00012		\$ 63.00	\$ 61.00	4	\$ 12.00
1.1351 to 1.510 28.831mm to 38.35mm	XX	.000030	Go 1 5/8	\$ 87.00	\$ 86.00	5	\$ 13.00
	X	.000060	NoGo 3/4	\$ 69.00	\$ 68.00	5	\$ 13.00
	Y	.000090		\$ 67.00	\$ 65.00	5	\$ 13.00
	Z	.00012		\$ 67.00	\$ 65.00	5	\$ 13.00

TAPERLOCK CYLINDRICAL PLUG GAGES

CARBIDE

QUANTITY DISCOUNT 5 OR MORE OF IDENTICAL SIZE LESS 10%

Size	Class	Tolerance	Length	QUANTITY 1		Handle #	Handle Price
				Go	Nogo		
.2301 to .365 5.841mm to 9.27mm	XX	.000020	Go 3/4	\$ 196.00	\$ 154.00	1	\$ 11.00
	X	.000040	NoGo 5/16	\$ 163.00	\$ 128.00	1	\$ 11.00
	Y	.000070		\$ 160.00	\$ 125.00	1	\$ 11.00
	Z	.0001		\$ 153.00	\$ 121.00	1	\$ 11.00
.3651 to .510 9.271mm to 12.95mm	XX	.000020	Go 1	\$ 202.00	\$ 179.00	2	\$ 11.00
	X	.000040	NoGo 3/8	\$ 168.00	\$ 149.00	2	\$ 11.00
	Y	.000070		\$ 164.00	\$ 147.00	2	\$ 11.00
	Z	.0001		\$ 161.00	\$ 141.00	2	\$ 11.00
.5101 to .825 12.951mm to 20.96mm	XX	.000020	Go 1 1/4	\$ 280.00	\$ 229.00	3	\$ 11.00
	X	.000040	NoGo 1/2	\$ 233.00	\$ 191.00	3	\$ 11.00
	Y	.000070		\$ 217.00	\$ 174.00	3	\$ 11.00
	Z	.0001		\$ 211.00	\$ 169.00	3	\$ 11.00
.8251 to 1.135 20.961mm to 28.83mm	XX	.000030	Go 1 1/2	\$ 355.00	\$ 283.00	4	\$ 12.00
	X	.000060	NoGo 5/8	\$ 296.00	\$ 236.00	4	\$ 12.00
	Y	.000090		\$ 286.00	\$ 227.00	4	\$ 12.00
	Z	.00012		\$ 280.00	\$ 223.00	4	\$ 12.00
1.1351 to 1.510 28.831mm to 38.35mm	XX	.000030	Go 1 5/8	\$ 519.00	\$ 430.00	5	\$ 13.00
	X	.000060	NoGo 3/4	\$ 433.00	\$ 358.00	5	\$ 13.00
	Y	.000090		\$ 426.00	\$ 349.00	5	\$ 13.00
	Z	.00012		\$ 420.00	\$ 345.00	5	\$ 13.00

TRILOCK CYLINDRICAL PLUG GAGES

STEEL

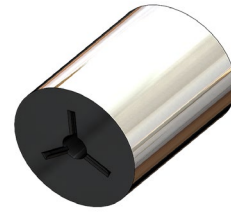
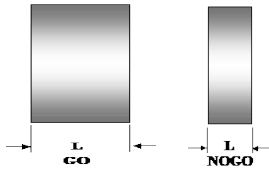

All Cylindrical Trilock plug gages are manufactured to ASME/ANSI B47.1 AGD standard and ASME/ANSI B89.1.5 standard. Gaging surface is hardened to Rc 60-62.

QUANTITY DISCOUNT 5 OR MORE OF IDENTICAL SIZE LESS 10% CHROME add 50%

Size	Class	Tolerance	Length	QUANTITY 1		Handle #	Handle Price
				Go	Nogo		
.760 to .947 19.301mm to 24.05mm	XX	See Chart	Go 1 1/4	\$ 93.00	\$ 92.00	2 1/2	\$ 14.00
	X		NoGo 3/4	\$ 72.00	\$ 72.00	2 1/2	\$ 14.00
	Y			\$ 68.00	\$ 67.00	2 1/2	\$ 14.00
	Z			\$ 65.00	\$ 64.00	2 1/2	\$ 14.00
.9471 to 1.135 24.051mm to 28.83mm	XX	.000030	Go 1 3/8	\$ 91.00	\$ 88.00	3 1/2	\$ 14.00
	X	.000060	NoGo 3/4	\$ 71.00	\$ 68.00	3 1/2	\$ 14.00
	Y	.000090		\$ 67.00	\$ 65.00	3 1/2	\$ 14.00
	Z	.00012		\$ 64.00	\$ 62.00	3 1/2	\$ 14.00
1.1351 to 1.510 28.831mm to 38.35mm	XX	.000030	Go 1 1/2	\$ 91.00	\$ 89.00	4 1/2	\$ 14.00
	X	.000060	NoGo 3/4	\$ 71.00	\$ 70.00	4 1/2	\$ 14.00
	Y	.000090		\$ 68.00	\$ 67.00	4 1/2	\$ 14.00
	Z	.00012		\$ 65.00	\$ 64.00	4 1/2	\$ 14.00
1.5101 to 2.010 38.351mm to 51.05mm	XX	.000040	Go 1 7/8	\$ 127.00	\$ 122.00	5 1/2	\$ 17.00
	X	.000080	NoGo 7/8	\$ 98.00	\$ 94.00	5 1/2	\$ 17.00
	Y	.00012		\$ 92.00	\$ 90.00	5 1/2	\$ 17.00
	Z	.00016		\$ 88.00	\$ 86.00	5 1/2	\$ 17.00
2.0101 to 2.510 51.051mm to 63.75mm	XX	.000040	Go 2	\$ 146.00	\$ 135.00	6	\$ 17.00
	X	.000080	NoGo 7/8	\$ 107.00	\$ 105.00	6	\$ 17.00
	Y	.00012		\$ 102.00	\$ 99.00	6	\$ 17.00
	Z	.00016		\$ 97.00	\$ 94.00	6	\$ 17.00
2.5101 to 3.010 63.751mm to 76.45mm	XX	.000050	Go 2	\$ 170.00	\$ 160.00	7	\$ 18.00
	X	.0001	NoGo 1	\$ 125.00	\$ 114.00	7	\$ 18.00
	Y	.00015		\$ 110.00	\$ 100.00	7	\$ 18.00
	Z	.0002		\$ 105.00	\$ 96.00	7	\$ 18.00
3.0101 to 3.510 76.451mm to 89.15mm	XX	.000050	Go 2	\$ 248.00	\$ 205.00	7	\$ 18.00
	X	.0001	NoGo 1	\$ 191.00	\$ 164.00	7	\$ 18.00
	Y	.00015		\$ 184.00	\$ 143.00	7	\$ 18.00
	Z	.0002		\$ 175.00	\$ 136.00	7	\$ 18.00
3.5101 to 4.010 89.151mm to 101.85mm	XX	.000050	Go 2 1/8	\$ 271.00	\$ 220.00	7	\$ 18.00
	X	.0001	NoGo 1	\$ 216.00	\$ 169.00	7	\$ 18.00
	Y	.00015		\$ 198.00	\$ 160.00	7	\$ 18.00
	Z	.0002		\$ 189.00	\$ 146.00	7	\$ 18.00
4.0101 to 4.510 101.851mm to 114.55mm	XX	.000050	Go 2 1/8	\$ 334.00	\$ 266.00	7	\$ 18.00
	X	.0001	NoGo 1	\$ 257.00	\$ 205.00	7	\$ 18.00
	Y	.00015		\$ 244.00	\$ 194.00	7	\$ 18.00
	Z	.0002		\$ 232.00	\$ 184.00	7	\$ 18.00
4.5101 to 5.010 114.551mm to 127.25mm	XX	.000065	Go 2 1/8	\$ 386.00	\$ 298.00	7	\$ 18.00
	X	.00013	NoGo 1	\$ 298.00	\$ 218.00	7	\$ 18.00
	Y	.00019		\$ 283.00	\$ 205.00	7	\$ 18.00
	Z	.00025		\$ 269.00	\$ 195.00	7	\$ 18.00
5.0101 to 5.510 127.251mm to 139.95mm	XX	.000065	Go 2 1/8	\$ 395.00	\$ 346.00	7	\$ 18.00
	X	.00013	NoGo 1	\$ 305.00	\$ 225.00	7	\$ 18.00
	Y	.00019		\$ 290.00	\$ 209.00	7	\$ 18.00
	Z	.00025		\$ 276.00	\$ 199.00	7	\$ 18.00
5.5101 to 6.010 139.951mm to 152.65mm	XX	.000065	Go 2 1/8	\$ 410.00	\$ 390.00	7	\$ 18.00
	X	.00013	NoGo 1	\$ 317.00	\$ 269.00	7	\$ 18.00
	Y	.00019		\$ 301.00	\$ 253.00	7	\$ 18.00
	Z	.00025		\$ 286.00	\$ 240.00	7	\$ 18.00
6.0101 to 6.510 152.651mm to 165.35mm	XX	.000065	Go 2 1/8	\$ 426.00	\$ 391.00	7	\$ 18.00
	X	.00013	NoGo 1	\$ 330.00	\$ 293.00	7	\$ 18.00
	Y	.00019		\$ 314.00	\$ 278.00	7	\$ 18.00
	Z	.00025		\$ 298.00	\$ 255.00	7	\$ 18.00
6.5101 to 7.010 165.351mm to 178.05mm	XX	.000080	Go 2 1/8	\$ 622.00	\$ 404.00	7	\$ 18.00
	X	.00016	NoGo 1	\$ 480.00	\$ 306.00	7	\$ 18.00
	Y	.00024		\$ 458.00	\$ 289.00	7	\$ 18.00
	Z	.00032		\$ 435.00	\$ 277.00	7	\$ 18.00
7.0101 to 7.510 178.051mm to 190.75mm	XX	.000080	Go 2 1/8	\$ 642.00	\$ 436.00	7	\$ 18.00
	X	.00016	NoGo 1	\$ 493.00	\$ 350.00	7	\$ 18.00
	Y	.00024		\$ 470.00	\$ 339.00	7	\$ 18.00
	Z	.00032		\$ 447.00	\$ 322.00	7	\$ 18.00
7.5101 to 8.010 190.751 to 203.45mm	XX	.000080	Go 2 1/8	\$ 674.00	\$ 528.00	7	\$ 18.00
	X	.00016	NoGo 1	\$ 520.00	\$ 440.00	7	\$ 18.00
	Y	.00024		\$ 493.00	\$ 425.00	7	\$ 18.00
	Z	.00032		\$ 468.00	\$ 404.00	7	\$ 18.00

TRILOCK CYLINDRICAL PLUG GAGES

CARBIDE

QUANTITY DISCOUNT 5 OR MORE OF IDENTICAL SIZE LESS 10%

Size	Class	Tolerance	Length	QUANTITY 1		Handle #	Handle Price
				Go	Nogo		
.760 to .825 19.301mm to 20.96mm	XX	.00002	Go 1 1/4	\$ 410.00	\$ 318.00	2 1/2	\$ 14.00
	X	.00004	NoGo 3/4	\$ 342.00	\$ 265.00	2 1/2	\$ 14.00
	Y	.000070		\$ 329.00	\$ 257.00	2 1/2	\$ 14.00
	Z	.0001		\$ 320.00	\$ 248.00	2 1/2	\$ 14.00
.8251 to .947 20.961mm to 24.05mm	XX	.000030	Go 1 1/4	\$ 449.00	\$ 361.00	2 1/2	\$ 14.00
	X	.000060	NoGo 3/4	\$ 374.00	\$ 301.00	2 1/2	\$ 14.00
	Y	.000090		\$ 361.00	\$ 282.00	2 1/2	\$ 14.00
	Z	.00012		\$ 355.00	\$ 274.00	2 1/2	\$ 14.00
.9471 to 1.135 24.051mm to 28.82mm	XX	.000030	Go 1 3/8	\$ 532.00	\$ 438.00	3 1/2	\$ 14.00
	X	.000060	NoGo 3/4	\$ 443.00	\$ 365.00	3 1/2	\$ 14.00
	Y	.000090		\$ 428.00	\$ 349.00	3 1/2	\$ 14.00
	Z	.00012		\$ 400.00	\$ 324.00	3 1/2	\$ 14.00
1.1351 to 1.344 28.821mm to 34.13mm	XX	.000030	Go 1 1/2	\$ 616.00	\$ 509.00	4 1/2	\$ 14.00
	X	.000060	NoGo 3/4	\$ 513.00	\$ 424.00	4 1/2	\$ 14.00
	Y	.000090		\$ 502.00	\$ 417.00	4 1/2	\$ 14.00
	Z	.00012		\$ 492.00	\$ 406.00	4 1/2	\$ 14.00
1.3441 to 1.510 34.131mm to 38.35mm	XX	.000030	Go 1 1/2	\$ 713.00	\$ 636.00	4 1/2	\$ 14.00
	X	.000060	NoGo 3/4	\$ 594.00	\$ 530.00	4 1/2	\$ 14.00
	Y	.000090		\$ 558.00	\$ 492.00	4 1/2	\$ 14.00
	Z	.00012		\$ 523.00	\$ 462.00	4 1/2	\$ 14.00
1.5101 to 1.760 38.351mm to 44.70mm	XX	.000040	Go 1 7/8	\$ 899.00	\$ 785.00	5 1/2	\$ 17.00
	X	.000080	NoGo 7/8	\$ 749.00	\$ 655.00	5 1/2	\$ 17.00
	Y	.00012		\$ 672.00	\$ 580.00	5 1/2	\$ 17.00
	Z	.00016		\$ 665.00	\$ 572.00	5 1/2	\$ 17.00

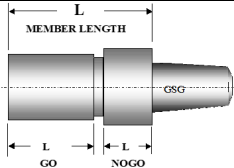

PROGRESSIVE CYLINDRICAL PLUG GAGES
STEEL

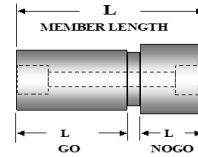

QUANTITY DISCOUNT 5 OR MORE OF IDENTICAL SIZE LESS 10%

CHROME ADD 50%

TAPERLOCK STYLE						
Size	Class	Tolerance	Length	QUANTITY	Handle #	Handle Price
				1		
.105 to .150 2.671mm to 3.81mm	XX	.000020	Go 3/8	\$ 128.00	00	\$ 12.00
	X	.000040	NoGo 7/32	\$ 107.00	00	\$ 12.00
	Y	.000070		\$ 100.00	00	\$ 12.00
	Z	.0001		\$ 100.00	00	\$ 12.00
.1501 to .230 3.811mm to 5.84mm	XX	.000020	Go 13/32	\$ 120.00	0	\$ 12.00
	X	.000040	NoGo 9/32	\$ 100.00	0	\$ 12.00
	Y	.000070		\$ 96.00	0	\$ 12.00
	Z	.0001		\$ 96.00	0	\$ 12.00
.2301 to .365 5.841mm to 9.27mm	XX	.000020	Go 3/4	\$ 122.00	1	\$ 11.00
	X	.000040	NoGo 5/16	\$ 102.00	1	\$ 11.00
	Y	.000070		\$ 97.00	1	\$ 11.00
	Z	.0001		\$ 97.00	1	\$ 11.00
.3651 to .510 9.271mm to 12.95mm	XX	.000020	Go 1	\$ 126.00	2	\$ 11.00
	X	.000040	NoGo 3/8	\$ 105.00	2	\$ 11.00
	Y	.000070		\$ 98.00	2	\$ 11.00
	Z	.0001		\$ 98.00	2	\$ 11.00
.5101 to .825 12.951mm to 20.96mm	XX	.000020	Go 1 1/4	\$ 137.00	3	\$ 11.00
	X	.000040	NoGo 1/2	\$ 114.00	3	\$ 11.00
	Y	.000070		\$ 105.00	3	\$ 11.00
	Z	.0001		\$ 105.00	3	\$ 11.00
.8251 to 1.135 20.961mm to 28.83mm	XX	.000030	Go 1 3/8	\$ 154.00	4	\$ 12.00
	X	.000060	GoNo 5/8	\$ 128.00	4	\$ 12.00
	Y	.000090		\$ 118.00	4	\$ 12.00
	Z	.00012		\$ 118.00	4	\$ 12.00
1.1351 to 1.510 28.831mm to 38.35mm	XX	.000030	Go 1 1/2	\$ 194.00	5	\$ 26.00
	X	.000060	GoNo 3/4	\$ 151.00	5	\$ 26.00
	Y	.000090		\$ 141.00	5	\$ 26.00
	Z	.00012		\$ 141.00	5	\$ 26.00
TRILOCK STYLE						
Size	Class	Tolerance	Length	QUANTITY	Handle #	Handle Price
				1		
1.5101 to 2.010 38.351mm to 51.05mm	XX	.000040	Go 1 7/8	\$ 265.00	5 1/2 SE	\$ 17.00
	X	.000080	NoGo 7/8	\$ 221.00	5 1/2 SE	\$ 17.00
	Y	.00012		\$ 210.00	5 1/2 SE	\$ 17.00
	Z	.00016		\$ 210.00	5 1/2 SE	\$ 17.00
2.0101 to 2.510 51.051mm to 63.75mm	XX	.000040	Go 2	\$ 312.00	6 SE	\$ 17.00
	X	.000080	NoGo 7/8	\$ 248.00	6 SE	\$ 17.00
	Y	.00012		\$ 226.00	6 SE	\$ 17.00
	Z	.00016		\$ 226.00	6 SE	\$ 17.00
2.5101 to 3.010 63.751mm to 76.45mm	XX	.000050	Go 2	\$ 350.00	7 SE	\$ 18.00
	X	.0001	NoGo 7/8	\$ 279.00	7 SE	\$ 18.00
	Y	.00015		\$ 255.00	7 SE	\$ 18.00
	Z	.0002		\$ 244.00	7 SE	\$ 18.00
3.0101 to 3.510 76.451mm to 89.15mm	XX	.000050	Go 2	\$ 436.00	7 SE	\$ 18.00
	X	.0001	NoGo 7/8	\$ 311.00	7 SE	\$ 18.00
	Y	.00015		\$ 287.00	7 SE	\$ 18.00
	Z	.0002		\$ 287.00	7 SE	\$ 18.00
3.5101 to 4.010 89.151mm to 101.85mm	XX	.000050	Go 2 1/8	\$ 508.00	7 SE	\$ 18.00
	X	.0001	NoGo 7/8	\$ 382.00	7 SE	\$ 18.00
	Y	.00015		\$ 333.00	7 SE	\$ 18.00
	Z	.0002		\$ 318.00	7 SE	\$ 18.00
4.0101 to 4.510 101.851mm to 114.55mm	XX	.000050	Go 2 1/8	\$ 579.00	7 SE	\$ 18.00
	X	.0001	NoGo 7/8	\$ 436.00	7 SE	\$ 18.00
	Y	.00015		\$ 384.00	7 SE	\$ 18.00
	Z	.0002		\$ 366.00	7 SE	\$ 18.00

CYLINDRICAL TAPER GAGES

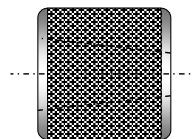

NATIONAL MACHINE TAPERS

Taper #	Large End	Small End	Length	Price Each	
				Plug	Ring
5	.500	.2995	.6875	\$ 552.00	\$ 885.00
10	.625	.3698	.8750	\$ 431.00	\$ 774.00
15	.750	.4401	1.0625	\$ 431.00	\$ 774.00
20	.875	.4922	1.3125	\$ 431.00	\$ 731.00
25	1.000	.5443	1.5625	\$ 452.00	\$ 731.00
30	1.250	.7031	1.8750	\$ 496.00	\$ 774.00

Taper #	Large End	Small End	Length	Price Each	
				Plug	Ring
35	1.500	.8438	2.2500	\$ 563.00	\$ 822.00
40	1.750	1.0026	2.5625	\$ 621.00	\$ 869.00
45	2.250	1.2839	3.3125	\$ 676.00	\$ 932.00
50	2.750	1.5833	4.0000	\$ 735.00	\$ 992.00
55	3.500	1.9870	5.1875	\$ 774.00	\$ 1,058.00
60	4.250	2.3906	6.3750	\$ 802.00	\$ 1,127.00

JARNO TAPERS - W/O TANG .6000" TPF

Taper #	Large End	Small End	Length	Price Each	
				Plug	Ring
1	.125	.100	.500	\$ 552.00	\$ 885.00
2	.250	.200	1.00	\$ 552.00	\$ 885.00
3	.375	.300	1.50	\$ 610.00	\$ 774.00
4	.500	.400	2.00	\$ 610.00	\$ 817.00
5	.625	.500	2.50	\$ 452.00	\$ 799.00
6	.750	.600	3.00	\$ 475.00	\$ 817.00
7	.875	.700	3.50	\$ 499.00	\$ 774.00
8	1.000	.800	4.00	\$ 542.00	\$ 842.00
9	1.125	.900	4.50	\$ 575.00	\$ 885.00
10	1.250	1.000	5.00	\$ 603.00	\$ 920.00

Taper #	Large End	Small End	Length	Price Each	
				Plug	Ring
11	1.375	1.100	5.50	\$ 636.00	\$ 981.00
12	1.500	1.200	6.00	\$ 757.00	\$ 1,057.00
13	1.625	1.300	6.50	\$ 792.00	\$ 1,117.00
14	1.750	1.400	7.00	\$ 825.00	\$ 1,161.00
15	1.875	1.500	7.50	\$ 895.00	\$ 1,274.00
16	2.000	1.600	8.00	\$ 1,023.00	\$ 1,455.00
17	2.125	1.700	8.50	\$ 1,138.00	\$ 1,546.00
18	2.250	1.800	9.00	\$ 1,205.00	\$ 1,569.00
19	2.375	1.900	9.50	\$ 1,235.00	\$ 1,678.00
20	2.500	2.000	10.00	\$ 1,297.00	\$ 1,767.00

MORSE TAPERS

Taper #	Large End	Small End	Length	TPF	Plug Price		Ring Price	
					W/O Tang	W/Tang	W/O Tang	W/Tang
					0	.3561	.2520	2.00
1	.4750	.3690	2 1/8	.59858	\$ 610.00	\$ 762.00	\$ 868.00	\$ 1,086.00
2	.7000	.5720	2 9/16	.59941	\$ 475.00	\$ 593.00	\$ 817.00	\$ 1,022.00
3	.9380	.7780	3 3/16	.60235	\$ 500.00	\$ 625.00	\$ 774.00	\$ 968.00
4	1.2310	1.0200	4 1/16	.62326	\$ 575.00	\$ 719.00	\$ 860.00	\$ 1,075.00
4 1/2	1.500	1.2660	4 1/2	.62400	\$ 575.00	\$ 719.00	\$ 946.00	\$ 1,323.00
5	1.7480	1.4750	5 3/16	.63151	\$ 731.00	\$ 914.00	\$ 1,117.00	\$ 1,397.00
6	2.4940	2.1160	7 1/4	.62565	\$ 972.00	\$ 1,216.00	\$ 1,325.00	\$ 1,657.00
7	3.2700	2.7500	10	.62400	\$ 1,399.00	\$ 1,748.00	\$ 1,590.00	\$ 2,082.00



All Standard Tapers manufacture to ASME/ANSI B5.10 class Z unless otherwise specified.

- Cat V Flange Tapers
- Medical Luer Tapers
- Steep Machine Tapers

Other Tapers available from GSG

Certification for above tapers = \$60.00 ea

SPECIAL TAPERS

TAPER WORKSHEET



Please furnish what information you have on your special gaging requirements. Mark up drawing(s) to show any additional characteristics.

From:
 Name: _____
 Company: _____
 Phone: _____
 Fax: _____

FAX TO: 1-860-537-4332
EMAIL TO: SALES@GG.GSGAGE.COM

Note: All tapers are held to +/- .0001 at large end diameter.
 Small end diameter reference only.
 Taper tolerance +/- .000050 inch per inch.
 Please specify if your requirements are different.

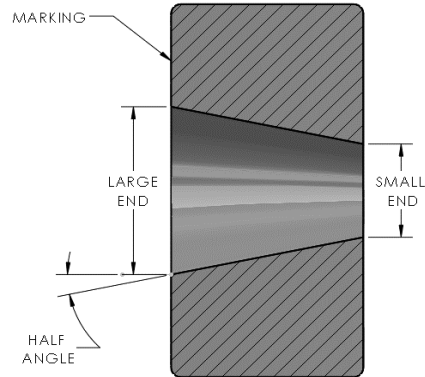

Mark Size: _____
 Tool #: _____

Steps at large end or small end (optional) _____

RING GAGE

Diameter @ Small End: _____
 Diameter @ Large End: _____
 Overall Length of Taper: _____

Taper/Ft: _____
 Taper/In: _____
 Taper Tol: _____ Inch/inch
 1/2 Angle: _____
 Included Angle: _____

Mark Size: _____
 Tool #: _____

TOOL MARKING

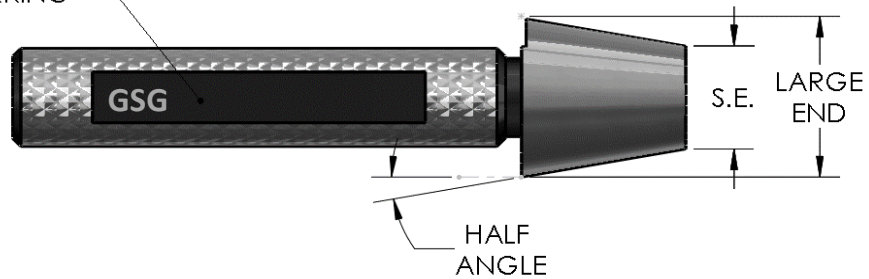

Steps at larg

PLUG GAGE

Diameter @ Small End: _____
 Diameter @ Large End: _____
 Overall Length of Taper: _____

Taper/Ft: _____
 Taper/In: _____
 Taper Tol: _____ Inch/inch
 1/2 Angle: _____
 Included Angle: _____



For interactive quote forms online, click on this code



SURVEILLANCE MASTERS

Micrometer Set Masters (except 01-1) are chrome plated to reduce wear and prevent rust.

MICROMETER SET MASTERS

Model #	Price
01-1E (English)	\$ 687.00
01-1M (Metric)	\$ 687.00
Certification	\$ 90.00
Plastic Storage Case	\$ 60.00

.100" to 1.00" with .512" and .762" for offset
01-1 is Stainless Steel to reduce wear and prevent rust.
Hardened, stabilized, ground to +/- .0001".



Model #	Price
16-1 (English)	\$ 1,173.00
16-1M (Metric)	\$ 1,173.00
Certification	\$ 90.00
Wood Storage Case	\$ 240.00

1.00" to 6.00" diameter in one inch increments
25mm to 150mm diameter in 25mm increments.
Case hardened, stabilized, ground to +/- .0001"
or to +/- .0025mm.



Model #	Price
16-1/2E (English)	\$ 1,600.00
16-1/2M (Metric)	\$ 1,600.00
Certification	\$ 180.00
Wood Storage Case	\$ 360.00

1/2" to 6.00" diameter in 1/2 inch increments.
12.5mm to 150mm diameter in 12.5mm increments
Case hardened, stabilized, ground to +/- .0001"
or +/- .0025mm.



Model #	Price
112E (English)	\$ 2,200.00
112M (Metric)	\$ 2,200.00
Certification	\$ 220.00
Wood Storage Case	\$ 360.00

1.00" to 12.00" diameter in one inch increments.
25mm to 300mm diameter in 25mm increments.
Case hardened, stabilized, ground to +/- .0001"
or +/- .0025mm.



112E shown
Custom Sizes Available

VERNIER CALIPER MASTERS

Model #	6.00" or 150mm Model	12.00" or 300mm Model	24.00" or 600mm Model
VC-1E (English)	\$ 767.00	\$ 3,067.00	\$ 6,772.00
VC-1M (Metric)	\$ 767.00	\$ 3,067.00	\$ 6,772.00
Certification	\$ 90.00	\$ 180.00	\$ 260.00
Storage Case	\$ 60.00	\$ 140.00	\$ 225.00
Manufactured Tolerance	±.0002 or .005mm	±.0005 or .013mm	±.001 or .025mm

For both inside and outside jaw measurements,
each step is hand lapped on both sides. All
steps are in 1/2" in English and 12.70mm in
Metric increments.



Scan the code to be taken to our
technical booklet for more information on our
surveillance products

SURVEILLANCE MASTERS & ARTIFACTS

ADM DEPTH MIC MASTER

Model #	Price
ADM-E(English)	\$ 3,200.00
ADM-E Riser (increase depth range x 2)	\$ 867.00
ADM-M(Metric)	\$ 3,200.00
ADM-M Riser (increase depth range x 2)	\$ 867.00
Certification	\$ 225.00
Wood ADM Storage Box by Gerstner	\$ 260.00
Wood ADM & Riser Storage Box by Gerstner	\$ 320.00

Depth's obtainable w/out Riser
 .500" to 5.50" in one inch steps, +/- .0001"
 12.5mm to 137.5mm in 25mm steps, +/- .0025mm.

Depth's obtainable w/Riser
 .500" to 11.50" in one inch steps +/- .0002
 12.5mm to 287.5mm in 25mm steps, +/- .005mm.



ADM Riser
(optional) **ADM**

GSG CMM QUIKCHEK'S

QUIKCHEK is your mechanical assurance of CMM accuracy.
 All QUIKCHEKS are 440c stainless steel
 hardened to Rc 60-62, Stress relieved & triple stabilized.
Certification Included
 Special sizes available, contact factory.

Model #	Price	Aluminum Case	Wood Case
4 inch	\$ 2,400.00	\$ 280.00	\$ 280.00
5 inch	\$ 3,710.00	\$ 300.00	\$ 300.00
8 inch	\$ 4,325.00	\$ 320.00	\$ 320.00
16 inch	\$ 12,733.00	\$ 465.00	N/A

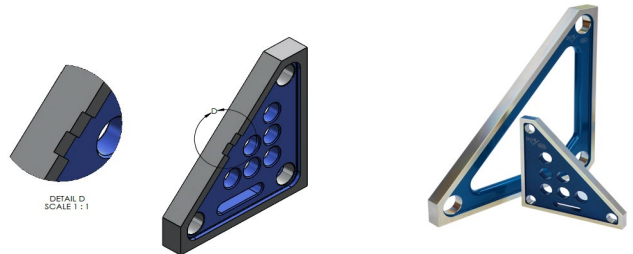

(shown) 5.00" QuikChek with depth notches

(shown) 8.00" & 16.00" QuikChek Models



Wood Storage Boxes by Gerstner



Click on the code for more product info and video

GSG GEOCHEK CIRCULAR ROUNDNESS MASTER

Model #	Price
GC-1	\$ 1,490.00
Case	\$ 112.00

Master for circular geometry systems.
 Precision Test & Set-up master.
 All Geometric Cheks are supplied with complete certs.
 Certs includes roundness & concentricity in three planes,
 perpendicularity (squareness) check & parallelism.
 All GeoChek's are 440c stainless steel
 Product Dimensions: 3.000" O.D x 2.000" I.D. x 4.000" Long



GSG Z-AXIS MASTERS

Model #	Price
LX-1	+/- .00005 \$ 757.00
GX-1	+/- .0001 \$ 680.00
Case	\$ 160.00

Master for calibrating the Z axis on your optical CMM. Certified to the nearest .000010".
 LX-1 Lapped base with mirror finish.
 GX-1 Ground finish base for less reflection.
 Supplied with certification.
 All Z-Axis Cheks are 440c stainless steel

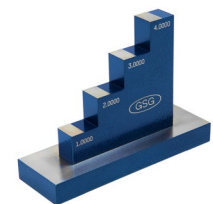

Scan the code to be taken to our technical booklet for more information on our surveillance products

MASTER SETTING PLUGS CLASS "W" FULL FORM

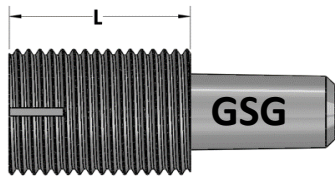

Other sizes available, contact factory.

METRIC 6g (Go Basic)				Handle #	Handle Price
Size	Length	Pitch Diameter	Price		
M1.6 x .35	1/4	1.354	\$ 154.00	000	\$ 12.00
M2 x 4	1/4	1.721	\$ 141.00	000	\$ 12.00
M2.5 x .45	1/4	2.188	\$ 141.00	000	\$ 12.00
M3 x .5	5/16	2.655	\$ 141.00	00	\$ 12.00
M4 x .7	13/32	3.523	\$ 139.00	00	\$ 12.00
M5 x .8	13/32	4.456	\$ 139.00	0	\$ 11.00
M6 x 1	1/2	5.324	\$ 117.00	1	\$ 11.00
M8 x 1.25	1/2	7.160	\$ 117.00	1	\$ 11.00
M10 x 1.5	3/4	8.994	\$ 127.00	2	\$ 11.00
M10 x 1.25	3/4	9.160	\$ 127.00	2	\$ 11.00
M12 x 1.75	3/4	10.890	\$ 131.00	2	\$ 11.00
M12 x 1.25	3/4	11.160	\$ 131.00	2	\$ 11.00
M14 x 2	7/8	12.663	\$ 148.00	3	\$ 11.00
M14 x 1.5	7/8	12.994	\$ 148.00	3	\$ 11.00
M16 x 2	7/8	14.663	\$ 177.00	3	\$ 11.00
M20 x 1.5	7/8	18.994	\$ 207.00	4	\$ 12.00
M22 x 1.5	1	20.994	\$ 219.00	4	\$ 12.00
M24 x 3	1	22.003	\$ 246.00	4	\$ 12.00

TRI-ROLL GAGING ROLLS

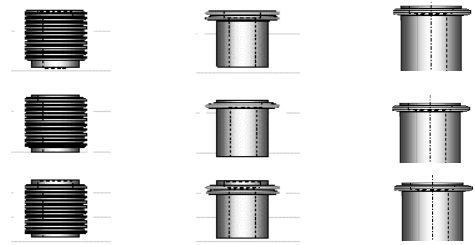

Type 3 Full Profile Functional Size Diameter	Type 4 Cone & Vee Single Element Pitch Diameter	Type 5 "Best Wire" Radius Single Element Pitch Diameter
\$ 380.00		\$ 221.00
\$ 380.00		\$ 221.00
\$ 380.00		\$ 221.00
\$ 380.00		\$ 221.00
\$ 380.00	\$ 331.00	\$ 221.00
\$ 380.00	\$ 331.00	\$ 221.00
\$ 380.00	\$ 331.00	\$ 221.00
\$ 380.00	\$ 331.00	\$ 221.00
\$ 380.00	\$ 331.00	\$ 221.00
\$ 380.00	\$ 331.00	\$ 221.00
\$ 380.00	\$ 331.00	\$ 221.00
\$ 380.00	\$ 331.00	\$ 221.00
\$ 380.00	\$ 331.00	\$ 221.00
\$ 380.00	\$ 331.00	\$ 221.00
\$ 380.00	\$ 331.00	\$ 221.00
\$ 380.00	\$ 331.00	\$ 221.00
\$ 391.00	\$ 372.00	\$ 256.00
\$ 391.00	\$ 372.00	\$ 256.00
\$ 391.00	\$ 372.00	\$ 256.00

TYPE 3 Functional Diameter Size	TYPE 4 Cone & Vee Single Element Pitch Diameter	TYPE 5 "Best Wire" Radius-Single Element Pitch Diameter
<p>Full ribbed rolls for functional diameter size for pitches coarser than 48 TPI (For 48 TPI and finer the ribs locate on alternate threads)</p>	<p>Two ribs (Vee type) on lower rolls (No 1 and 3) One rib (Cone type) on upper roll (No 2) Flank contact limited to 0.1 pitch.</p>	<p>Single ribs only with "Best Wire" size radius for any given pitch (TPI)</p>

SPECIAL ORDER - CONTACT FACTORY

TYPE 6-PLAIN ROLLS THREAD MAJOR DIA AND PLAIN CYLINDRICAL PARTS	TYPE 7-MINOR DIAMETER	TYPE 8-LEAD/FLANK ANGLE FULL PROFILE SINGLE ELEMENT PITCH DIA
<p>Straight cylindrical rolls for checking diameter and out-of-roundness.</p>	<p>(55 degree included angle) Two full profile "Vee" rolls (no.1 and 3) One full profile "Cone" roll (no.2).</p>	<p>Outside flanks relieved. One full profile "Cone" roll (no. 2)</p>

TRI-ROLL COMPONENTS



Frame, Indicator with Stand



**Dual Frame Assembly
(with frames assembled)**

There are 5 components that comprise a complete Tri-Roll system. To assist you in ordering, we have separated each of the five components into pricing tables with the size range & price.

1. Base & Accessories	
Description	Price
Base	\$ 48.00
Multiple Mounting Bar	\$ 49.00
Dual Frame Base Assembly	\$ 96.00
Aluminum Handle for Hand Held Unit	\$ 59.00

2. Frames				
Frame #	Range-Nominal Size		Roll Length Per Inch	Price
	Above	To & Including		
0	.059 (1.5mm)	.073 (1.8mm)	.223	\$ 453.00
1	.073 (1.8mm)	.099 (2.5mm)	.223	\$ 453.00
2	.099 (2.5mm)	.164 (4.2mm)	.223	\$ 461.00
3	.164 (4.2mm)	.313 (7.9mm)	.424	\$ 461.00
4	.313 (7.9mm)	.500 (12.7mm)	.424	\$ 469.00
5	.500 (12.7mm)	.750 (19.0mm)	.626	\$ 469.00
6	.750 (19.0mm)	1.125 (28.5mm)	.931	\$ 492.00
7	1.125 (28.5mm)	1.500 (38.1mm)	.931	\$ 492.00
8	1.500 (38.1mm)	1.875 (47.6mm)	.931	\$ 738.00
9	1.875 (47.6mm)	2.250 (57.1mm)	.931	\$ 783.00
10	2.250 (57.1mm)	2.625 (66.7mm)	.931	\$ 822.00
11	2.625 (66.7mm)	3.000 (76.2mm)	.931	\$ 973.00
12	3.000 (76.2mm)	3.375 (85.7mm)	.931	\$ 1,042.00

3. Dial Indicator		
Style	Graduations	Price
Dial Indicator	.0001 inch	\$ 245.00
Dial Indicator	.00025 inch	\$ 245.00
Dial Indicator	0.002mm Metric	\$ 245.00
Electronic Indicator		P.O.A.

4. Stop Adjusting Tool	
	Price
Stop Adjusting Tool	\$ 27.00

5. Rolls (See pages 35 & 36)

COMPARATORS

STC COMPARATOR

1. BASE			
Description		Price	
Base		\$	48.00
Multiple Mounting Bar		\$	49.00
Dual Frame Base Assembly		\$	96.00
Aluminum Handle for Hand Held Unit		\$	59.00
2.FRAMES			
Frame #	Above	To & Include	Price
STC-101	.111(2.82mm)	.750(19.05mm)	\$ 689.00
STC-201	.750(19.05mm)	2.0(50.8mm)	\$ 689.00
3. DIAL INDICATOR			
Graduations		Price	
.0001 Inch		\$	245.00
.00025 Inch		\$	245.00
0.002mm Metric		\$	245.00
Electronic Indicator	Price on application		P.O.A.
4. GAGING SEGMENTS			
Above		To & Include	Price
.111(2.82mm)		.750(19.05mm)	\$ 416.00
.750(19.05mm)		2.0(50.8mm)	P.O.A.
Stop Adjusting Tool			Price
			\$ 27.00



1. Base with adapter
2. Frame- One frame for entire range #10 to 2 1/2 diameter.
3. Indicator - Analog or electronic indicators available.
4. Segments - Full profile or Cone & Vee.



ITC COMPARATOR

1. Base & Accessories			
Description		Price	
Base With Adapter		\$	101.00
Multiple Mounting Bar		\$	49.00
Dual Frame Base Assembly		\$	96.00
2. FRAMES			
Frame #	Above	To & Include	Price
100	.189 (4.8mm)	2.500 (63.5mm)	\$ 819.00
200	2.500 (63.5mm)	5.000 (127mm)	\$1,000.00
300	5.000 (127.0mm)	8.000 (203.2mm)	\$1,183.00
3. DIAL INDICATOR			
Graduations		Price	
.0001 Inch		\$	234.00
.00025 Inch		\$	234.00
0 .002 mm Metric		\$	234.00
Electronic Indicator		P.O.A.	



MASTER SETTING RINGS CLASS "W"

ITC SEGMENT GAGING

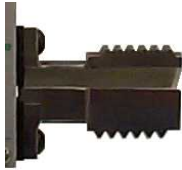

Functional Size
(Maximum Material
Condition) Use full
profile gaging segments

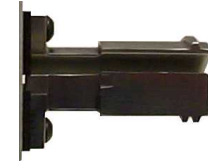
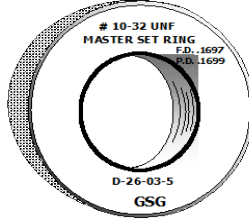

Pitch Diameter Size
(Minimum Material
Condition) Use single
element gaging
segments. Cone & Vee

INCH					
Size	Functional Size	Cone and Vee -		Solid Master	
	Functional Pitch Dia.	Single Element Pitch Dia.		Rings	
	Price	Price	Price	Price	Length
#10-24	\$ 442.00	\$ 486.00	\$ 447.00	3/8	
#10-32	\$ 442.00	\$ 486.00	\$ 447.00	3/8	
#12-24	\$ 442.00	\$ 486.00	\$ 447.00	3/8	
#12-28	\$ 442.00	\$ 486.00	\$ 447.00	3/8	
1/4-20	\$ 442.00	\$ 486.00	\$ 447.00	3/8	
1/4-28	\$ 442.00	\$ 486.00	\$ 447.00	3/8	
5/16-18	\$ 442.00	\$ 486.00	\$ 447.00	3/8	
5/16-24	\$ 442.00	\$ 486.00	\$ 447.00	3/8	
3/8-16	\$ 442.00	\$ 486.00	\$ 447.00	9/16	
3/8-24	\$ 442.00	\$ 486.00	\$ 447.00	9/16	
7/16-14	\$ 442.00	\$ 486.00	\$ 447.00	9/16	
7/16-20	\$ 442.00	\$ 486.00	\$ 447.00	9/16	
1/2-13	\$ 442.00	\$ 486.00	\$ 447.00	9/16	
1/2-20	\$ 442.00	\$ 486.00	\$ 447.00	9/16	
9/16-12	\$ 549.00	\$ 593.00	\$ 519.00	9/16	
9/16-18	\$ 549.00	\$ 593.00	\$ 519.00	9/16	
5/8-11	\$ 549.00	\$ 593.00	\$ 519.00	9/16	
5/8-18	\$ 549.00	\$ 593.00	\$ 519.00	9/16	
3/4-10	\$ 549.00	\$ 593.00	\$ 519.00	9/16	
3/4-16	\$ 549.00	\$ 593.00	\$ 519.00	9/16	
7/8-9	\$ 549.00	\$ 593.00	\$ 519.00	3/4	
7/8-14	\$ 549.00	\$ 593.00	\$ 519.00	3/4	
1"-8	\$ 549.00	\$ 593.00	\$ 519.00	3/4	
1"-12	\$ 549.00	\$ 593.00	\$ 519.00	3/4	
1"-14	\$ 549.00	\$ 593.00	\$ 519.00	3/4	
1 1/8"-7	\$ 568.00	\$ 612.00	\$ 628.00	3/4	
1 1/8"-12	\$ 568.00	\$ 612.00	\$ 628.00	3/4	
1 1/4"-7	\$ 568.00	\$ 612.00	\$ 628.00	3/4	
1 1/4"-12	\$ 568.00	\$ 612.00	\$ 628.00	3/4	
1 3/8"-6	\$ 568.00	\$ 612.00	\$ 628.00	3/4	
1 3/8"-12	\$ 568.00	\$ 612.00	\$ 628.00	3/4	
1 1/2"-6	\$ 568.00	\$ 612.00	\$ 628.00	3/4	
1 1/2"-12	\$ 568.00	\$ 612.00	\$ 628.00	3/4	

METRIC					
Size	Full Profile -	Cone and Vee -		Solid Master	
	Functional Pitch Dia.	Single Element Pitch Dia.		Rings	
	Price	Price	Price	Price	Length
M5x.8	\$ 442.00	\$ 486.00	\$ 447.00	3/8	
M6x1	\$ 442.00	\$ 486.00	\$ 447.00	3/8	
M8x1.25	\$ 442.00	\$ 486.00	\$ 447.00	9/16	
M10x1.5	\$ 442.00	\$ 486.00	\$ 447.00	9/16	
M10x1.25	\$ 442.00	\$ 486.00	\$ 447.00	9/16	
M12x1.75	\$ 442.00	\$ 486.00	\$ 447.00	9/16	
M12x1.25	\$ 442.00	\$ 486.00	\$ 447.00	9/16	
M14x2	\$ 549.00	\$ 593.00	\$ 519.00	9/16	
M14x1.5	\$ 549.00	\$ 593.00	\$ 519.00	9/16	
M16x2	\$ 549.00	\$ 593.00	\$ 519.00	9/16	
M20x1.5	\$ 549.00	\$ 593.00	\$ 519.00	3/4	
M22x1.5	\$ 549.00	\$ 593.00	\$ 519.00	3/4	
M24x3	\$ 549.00	\$ 593.00	\$ 519.00	3/4	

ZERO SPINDLES

Zero Spindle	
Spindle #	Price
AD-012	\$ 1,334.00
AD-013	\$ 1,607.00
AD-014	\$ 1,886.00
AD-015	\$ 2,134.00



Thread Checking Attachments	
EDP #	Price
AD-1200	\$ 489.00
ROLL FOR ABOVE	\$ 231.00



Zero Spindle Accessories					
For Spindle #	Centralizing Collar		For SPINDLE	Spindle-Loks	
	Collar #	Price		Lok #	Price
AD-012	AC-257	\$ 177.00	AD-012	AD-286	\$ 126.00
AD-013	AC-157-A	\$ 194.00	AD-013	AD-386	\$ 149.00
AD-014	AC-457-A	\$ 211.00	AD-014	AD-486	\$ 165.00
AD-015	AC-657-A	\$ 249.00	AD-015	AD-586	\$ 187.00

Zero Spindle Fixture Accessories			
Fixture Bases		Indicator Mount Assemblies	
Base #	Price	Assy #	Price
AD-1032	\$ 426.00	AD-006	\$ 415.00
AD-1033	\$ 530.00	AD-008	\$ 370.00
AD-1034	\$ 709.00	PLEASE SPECIFY POST LENGTH	
AD-1035	\$ 1,242.00	WHEN ORDERING THE AD-006	

Diaphragm Push Arbors and Zero Spindle Diaphragm Push Arbor Combinations						
For Spindle #	Flange Type Push Arbors and Combos				Between Centers Push Arbors	
	Arbor #	Price	Combo #	Price	Arbor #	Price
AD-012	AD-3222	\$ 1,219.00	AD-2220	\$ 2,791.00	AD-3221-A	\$ 1,093.00
AD-012	AD-3224	\$ 1,229.00	AD-2240	\$ 2,802.00	AD-3223-A	\$ 1,102.00
AD-012	AD-3228	\$ 1,242.00	AD-2290	\$ 2,814.00	AD-3225-A	\$ 1,112.00
AD-013	AD-3233	\$ 1,323.00	AD-2340	\$ 3,189.00	AD-3230-A	\$ 1,206.00
AD-014	AD-3243	\$ 1,632.00	AD-2440	\$ 3,813.00	AD-3240-A	\$ 1,326.00
AD-015	AD-3253	\$ 1,740.00	AD-2540	\$ 4,211.00	AD-3250-A	\$ 1,424.00
AD-015	AD-3263	\$ 1,780.00	AD-2640	\$ 4,297.00	AD-3260-A	\$ 1,510.00



Dual-Flex Push Arbors and Zero Spindle Dual-Flex Push Arbor Combinations						
For Spindle #	Flange Type Push Arbors and Combos				Between Centers Push Arbors	
	Arbor #	Price	Combo #	Price	Arbor #	Price
AD-012	DF-200-F	\$ 1,691.00	DF-200-C	\$ 3,284.00	DF-200	\$ 1,416.00
AD-012	DF-300-F	\$ 1,701.00	DF-300-C	\$ 3,295.00	DF-300	\$ 1,424.00
AD-012	DF-400-F	\$ 1,716.00	DF-400-C	\$ 3,311.00	DF-400	\$ 1,436.00
AD-012	DF-500-F	\$ 1,721.00	DF-500-C	\$ 3,317.00	DF-500	\$ 1,447.00
AD-013	DF-600-F	\$ 1,824.00	DF-600-C	\$ 3,715.00	DF-600	\$ 1,503.00
AD-013	DF-700-F	\$ 1,834.00	DF-700-C	\$ 3,723.00	DF-700	\$ 1,510.00
AD-014	DF-800-F	\$ 2,239.00	DF-800-C	\$ 4,447.00	DF-800	\$ 1,694.00
AD-014	DF-900-F	\$ 2,244.00	DF-900-C	\$ 4,455.00	DF-900	\$ 1,705.00
AD-015	DF-1000-F	\$ 2,398.00	DF-1000-C	\$ 4,901.00	DF-1000	\$ 1,818.00
AD-015	DF-1100-F	\$ 2,405.00	DF-1100-C	\$ 4,909.00	DF-1100	\$ 1,873.00
AD-015	DF-1200-F	\$ 2,439.00	DF-1200-C	\$ 4,945.00	DF-1200	\$ 1,980.00

Tork-Lok Arbors and Zero Spindle Tork-Lok Arbor Combinations

Standard Arbors and Combos					Short Series Arbors and Combos				
Spindle #	Arbor #	Price	Combo #	Price	Spindle #	Arbor #	Price	Combo #	Price
AD-013	AC-2110	\$ 631.00	AC-4110	\$ 2,718.00	AD-013	AC-8100	\$ 663.00	AC-10110	\$ 2,748.00
AD-013	AC-2210	\$ 644.00	AC-4210	\$ 2,727.00	AD-013	AC-8200	\$ 676.00	AC-10210	\$ 2,761.00
AD-013	AC-2310	\$ 663.00	AC-4310	\$ 2,748.00	AD-013	AC-8300	\$ 682.00	AC-10310	\$ 2,767.00
AD-014	AC-2410	\$ 676.00	AC-4410	\$ 3,092.00	AD-014	AC-8400	\$ 682.00	AC-10410	\$ 3,100.00
AD-014	AC-2510	\$ 684.00	AC-4510	\$ 3,104.00	AD-014	AC-8500	\$ 684.00	AC-10510	\$ 3,104.00
AD-015	AC-2610	\$ 792.00	AC-4610	\$ 3,543.00	AD-015	AC-8600	\$ 782.00	AC-10610	\$ 3,533.00
AD-015	AC-2710	\$ 846.00	AC-4710	\$ 3,595.00	AD-015	AC-8700	\$ 824.00	AC-10710	\$ 3,575.00
AD-015	AC-2810	\$ 1,148.00	AC-4810	\$ 3,898.00	AD-015	Standard and Short Series Collets are Available on Request			
AD-015	AC-2910	\$ 1,265.00	AC-4910	\$ 4,013.00	AD-015				



PLEASE CALL FACTORY TO ENSURE COLLET AND PART LENGTH MATCH

Zero Spindle 3 Jaw Chuck Combinations

EDP #	Zero Spindle	Chuck Size	Chuck Assembly #	Price
BSC-13	AD-013	4" 3-JAW	CA-13	\$ 3,598.00
BSC-15	AD-015	5" 3-JAW	CA-15	\$ 4,223.00



Zero Spindle 5C Collet Chuck Combination

EDP #	Zero Spindle	Chuck Size	Chuck Assembly #	Price
CFC-13	AD-013	5C	CFC-13	\$ 3,030.00

PRECISION 5C COLLETS ARE AVAILABLE ON REQUEST



Zero Spindle 1C Collet Chuck Combination

EDP #	Zero Spindle	Chuck Size	Chuck Assembly #	Price
CFC-12	AD-012	1C	CFC-12	\$ 2,729.00

PRECISION 1C COLLETS ARE AVAILABLE ON REQUEST



GSG CHAMFER GAGE - ORDERING GUIDE

PLACE GAGE ANVIL ON FLAT SURFACE & PRESS THE "ON/CLR" BUTTON

READY

- PLACE GAGE FIRMLY ON A FLAT SURFACE

SET

- PRESS "ON/CLR"

GO

- PLACE GAGE IN HOLE FEATURE
- (LARGE END SIZE DISPLAYS ON SCREEN)

INTERCHANGABLE ANVIL ENDS

THUMB RING

ANVIL ASSEMBLY

GSG LOW PROFILE STEM COLLET

GSG CHAMFER INDICATOR

US 2017/0299367 A1

P1= 2.0"

P2= 4.0"

P3= 6.0"

62.00°

92.00°

120.00°

135.00°

062

092

120

135

CUSTOM ANGLES AVAILABLE



Click on the code to see the interactive Chamfer Gage Catalog

The GSG Digital Chamfer Gage is sold as separate components. When placing a chamfer gage order you must purchase a **GAGE BODY** (shown to the left) along with an anvil end.

Each **GAGE BODY** is programmed for the desired angle anvil(s). Once they have been programmed at our factory they are dedicated to that particular angle.

After purchasing for a particular anvil angle, you can then purchase other diameter anvils but they must be the same angle that the gage was initially purchased for.

Anvils are available individually in both standard and custom sizes or they can be purchased in sets. (see page 41)

NEW ITEM		
Part #	Product Description	Price
GSG150CGB	GSG Indicator Body	\$ 645.00

GSG DIGITAL CHAMFER GAGE

The all new GSG Digital Chamfer Gage can be provided with any angle and any diameter. Buy several anvils and go from one feature check to another in as little as 20 seconds with a repeatability of .0001"
The most accurate and versatile chamfer gage on the market. Can be customized for virtually any hole feature.



- Hard Programmed Ratio Measuring Mode
- SPC Cables USB, MTI, RS232
- Measuring System in English or Metric
- Travel Reverse
- Auto Off
- Rotating Bezel
- T.I.R. Measuring with Low & High Storage Recall
- Powered by Batteries, AC Jack or Output Cable
- User Tolerance Settings
- Inch/Metric Display Conversion
- Large LCD Display
- Maximum Reading Hold
- Display / Freeze Reading Hold
- Extra Large Number Display

CUSTOM ANVIL CONFIGURATIONS TO MATCH YOUR APPLICATION!



GSG CHAMFER GAGE - INDIVIDUAL ANVILS

* Must be purchased with "GAGE BODY" found on page 41.

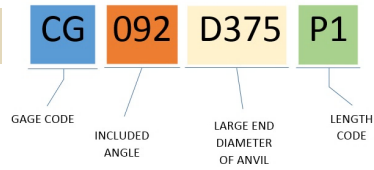

ITEM #	ANGLE (Included)	LARGE END DIAMETER	P1 LENGTH 2.00"	P2 LENGTH 4.00"	P3 LENGTH 6.00"
CG062D0375	62° ANVIL	0.3750	\$ 235.00	\$ 335.00	\$ 435.00
CG062D0500	62° ANVIL	0.5000	\$ 260.00	\$ 370.00	\$ 470.00
CG062D0750	62° ANVIL	0.7500	\$ 300.00	\$ 390.00	\$ 490.00
CG092D0375	92° ANVIL	0.3750	\$ 235.00	\$ 335.00	\$ 435.00
CG092D0500	92° ANVIL	0.5000	\$ 270.00	\$ 370.00	\$ 470.00
CG092D0750	92° ANVIL	0.7500	\$ 310.00	\$ 395.00	\$ 595.00
CG092D1250	92° ANVIL	1.2500	\$ 330.00	\$ 430.00	\$ 615.00
CG092D1500	92° ANVIL	1.5000	\$ 350.00	\$ 505.00	\$ 635.00
CG120D0750	120° ANVIL	0.7500	\$ 310.00	\$ 395.00	\$ 420.00
CG120D1500	120° ANVIL	1.5000	\$ 345.00	\$ 510.00	\$ 540.00
CG120D2500	120° ANVIL	2.5000	\$ 475.00	\$ 575.00	\$ 660.00
CG120D3250	120° ANVIL	3.2500	\$ 565.00	\$ 765.00	\$ 795.00
CG135D0750	135° ANVIL	0.7500	\$ 310.00	\$ 410.00	\$ 440.00
CG135D1500	135° ANVIL	1.5000	\$ 355.00	\$ 520.00	\$ 590.00
CG135D2500	135° ANVIL	2.5000	\$ 485.00	\$ 606.00	\$ 675.00
CG135D3500	135° ANVIL	3.5000	\$ 595.00	\$ 675.00	\$ 815.00

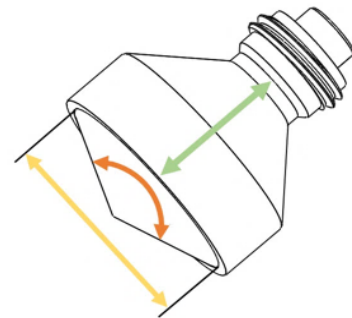

GSG CHAMFER GAGE - 3 PIECE "P1" SETS

(INCLUDES 1- GSG DIGITAL INDICATOR BODY AND ANVILS SHOWN IN THE CHART BELOW)

ITEM #	ANGLE (Included)	LENGTH	INCLUDES .375 DIA. ANVIL	INCLUDES .500 DIA. ANVIL	INCLUDES .750 DIA. ANVIL	INCLUDES 1.50 DIA. ANVIL	INCLUDES 2.50 DIA. ANVIL	PRICING
CG062P1	62° ANVIL	2.00	✓	✓	✓	X	X	\$ 1,627.00
CG092P1	92° ANVIL	2.00	✓	✓	✓	X	X	\$ 1,652.00
CG120P1	120° ANVIL	2.00	X	X	✓	✓	✓	\$ 1,850.00
CG135P1	135° ANVIL	2.00	X	X	✓	✓	✓	\$ 1,872.00

*ADDITIONAL SETS AVAILABLE ON-LINE



For the full digital catalog of GSG Chamfer Gage attachments scan this code

CHAMFER GAGE ACCESSORIES

ABS STORAGE CASES



It is unbreakable, watertight, airtight, dustproof, chemical resistant and corrosion proof. Our cases are constructed to protect your gages and prevent damage and corrosion.

High Impact structural copolymer that makes it extremely strong and durable. Its exclusive 1/4" (6.4 mm) neoprene o-ring and ABS latches seal perfectly

We waterjet the cutouts in the foam to conform to your gage ensuring a perfect fit.

Case Prices

Part #	Product	Price
CG1050	Chamfer Gage	\$ 199.00

*We can provide custom ABS cases on just about any product we manufacture
Pricing is upon request for products not listed.

Tighter L.E. Tolerance Available
Call Factory for pricing and availability

CHAMFER RING MASTERS

(±.0005 L.E. TOLERANCE W/CERTIFICATION)

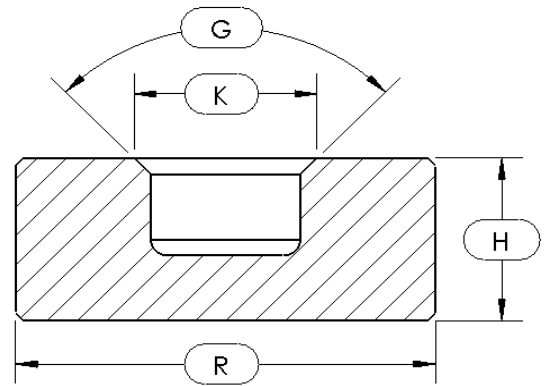

ITEM #	G	K	H	R	THRU HOLE SIZE	INCLUDES CERT.	A2 STEEL Rc58-62	CARBIDE W/STEEL JACKET
TPG90K250	90° INCLUDED	0.250	0.500	1.750	0.125	✓	\$ 230.00	\$ 385.00
TPG90K375	90° INCLUDED	0.375	0.500	1.750	0.200	✓	\$ 241.00	\$ 400.00
TPG90K500	90° INCLUDED	0.500	0.500	1.750	0.250	✓	\$ 253.00	\$ 415.00
TPG90K750	90° INCLUDED	0.750	0.750	2.000	0.500	✓	\$ 365.00	\$ 430.00
TPG90K100	90° INCLUDED	1.000	1.000	2.500	0.750	✓	\$ 278.00	\$ 446.00
TPG90K125	90° INCLUDED	1.250	1.000	2.500	1.000	✓	\$ 291.00	\$ 463.00
TPG90K150	90° INCLUDED	1.500	1.500	3.000	1.250	✓	\$ 305.00	\$ 481.00
TPG90K175	90° INCLUDED	1.750	1.500	3.500	1.500	✓	\$ 320.00	\$ 500.00
TPG90K200	90° INCLUDED	2.000	1.750	3.500	1.750	✓	\$ 336.00	\$ 520.00

FOR CUSTOM SIZES CONTACT FACTORY

*All Chamfer Masters come standard with flat lapped bottom

INDICATOR COLLETS



Lowest Profile Indicator Collet on the market!

Don't use up your indicator travel with a standard collet...

The GSG Indicator Collet is the lowest profile collet on the market. This allows for maximum travel to be obtained by utilizing the full throw allowed on the indicator stem.

Total stick out is .500" when mounted by the 5/8-18 thread. Available for both 3/8 (9.5mm) and 5/16" (7.9mm) indicator stems

Low Profile Collets

Part #	STEM DIAMETER	Price
CH375	3/8	\$ 25.00
CH312	5/16	\$ 25.00

For the full digital catalog of GSG Chamfer Gage attachments scan this code



MEDICAL GAGES HEXALOBES

All GSG Hexalobe Plug Gages are manufactured to ISO10664-2014 Standards
* Special sizes available upon request - Contact Factory

Most Hexalobe Plugs "In Stock"

Steel Prices

Hexalobe	Plugs	Rings
T-06	\$ 630.00	\$ 730.00
T-07	\$ 630.00	\$ 730.00
T-08	\$ 620.00	\$ 720.00
T-09	\$ 610.00	\$ 710.00
T-10	\$ 600.00	\$ 700.00
T-15	\$ 590.00	\$ 690.00
T-20	\$ 580.00	\$ 680.00
T-25	\$ 575.00	\$ 675.00
T-27	\$ 550.00	\$ 650.00
T-30	\$ 525.00	\$ 625.00
T-40	\$ 460.00	\$ 560.00
T-45	\$ 430.00	\$ 520.00
T-50	\$ 400.00	\$ 500.00
T-55	\$ 380.00	\$ 460.00
T-60	\$ 380.00	\$ 430.00
T-70	\$ 380.00	\$ 430.00
T-80	\$ 380.00	\$ 430.00
T-90	\$ 360.00	\$ 410.00
T-100	\$ 360.00	\$ 410.00
Calibrations	\$ 120.00	\$ 160.00

Carbide Prices

Hexalobe	Plugs	Rings (Steel Jacket w/carbide insert)
T-06	\$ 730.00	\$ 830.00
T-07	\$ 730.00	\$ 830.00
T-08	\$ 720.00	\$ 820.00
T-09	\$ 710.00	\$ 810.00
T-10	\$ 700.00	\$ 800.00
T-15	\$ 690.00	\$ 790.00
T-20	\$ 680.00	\$ 780.00
T-25	\$ 670.00	\$ 775.00
T-27	\$ 650.00	\$ 750.00
T-30	\$ 625.00	\$ 725.00
T-40	\$ 600.00	\$ 660.00
T-45	\$ 570.00	\$ 630.00
T-50	\$ 540.00	\$ 600.00
T-55	\$ 520.00	\$ 560.00
T-60	\$ 520.00	\$ 530.00
T-70	\$ 520.00	\$ 525.00
T-80	\$ 520.00	\$ 525.00
T-90	\$ 500.00	\$ 620.00
T-100	\$ 500.00	\$ 680.00
Calibrations	\$ 120.00	\$ 160.00

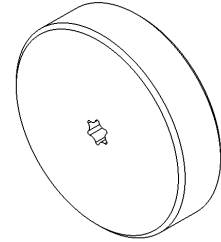
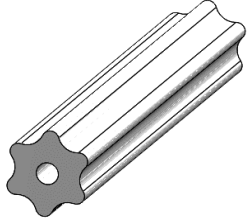

HEXALOBE PENETRATION GAGES

The GSG Hexalobe Depth Gage utilizes the components of our Digital Chamfer gage. This allows for interchangeable Anvils so the user can go from one size to another in under 20 seconds. Simply purchase the main body and add Hexalobe end(s) you need.

** ALL HEXALOBE DEPTH ATTACHMENTS COME WITH (1) CERTIFIED (GO) HEXALOBE MEMBER INSTALLED.



T-08 Attachment shown

GSG INDICATOR BODY	PRICE
GSG150CGB	\$ 645.00

(See product description on page 41)

** HEXALOBE ATTACHMENT	PRICE
T-06	\$ 1,310.00
T-07	\$ 1,270.00
T-08	\$ 1,250.00
T-09	\$ 1,230.00
T-10	\$ 1,170.00
T-15	\$ 1,140.00
T-20	\$ 1,110.00
T-25	\$ 1,050.00
T-27	\$ 1,010.00
T-30	\$ 950.00
T-40	\$ 910.00
T-45	\$ 880.00
T-50	\$ 850.00
T-55	\$ 830.00
T-60	\$ 830.00
T-70	\$ 830.00
T-80	\$ 830.00
T-90	\$ 810.00
T-100	\$ 810.00

10% OFF WHEN
PURCHASING 2 OR MORE

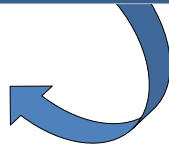

HEXALOBE COLLETS

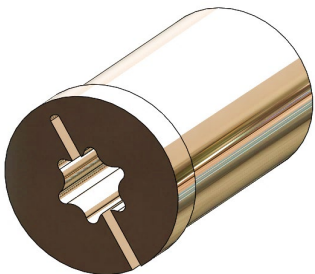

The GSG Hexalobe Collets allow male hexalobes to be held securely in standard wire handles.
All hexalobe collets are manufactured from brass.

Collets	
Hexalobe Size	Price
T06 - T10	\$ 35.00
T15 - T25	\$ 37.00
T27 - T55	\$ 40.00
T60 - T100	\$ 45.00

Handles	
	Price
Single	\$ 14.00
Double Ended	\$ 16.00



Hold Hexalobe Gages firmly in standard AGD style Handles

Hexalobe Handle Collets



NEW PRODUCTS

GSG DIGITAL INDICATORS

All indicators available with certification - \$30.00 each

GSG VRS Indicator

1.000" LCD travel indicator that can be programmed to view both numeric and analog at the same time. Increments down to .0001" / .002mm. Comes with Lifting Knob and Flat Back.

Built in Wireless & USB Cable Connect



VRS2110-GSG1 1.000" Travel Range \$ 420.00

Numeric & Analog Display

GSG VRS Indicator



Built in Wireless & USB Cable Connect

1.000" Travel indicator with .00005" / .001mm increments. Switch from inch/mm. Output via SPC Cable. Comes with Dust Cap and Flat Back

VRS3110-GSG1 1.000" Travel Range \$ 445.00

GSG VRS Indicator

.600" LCD travel indicator that can be programmed to view both numeric and analog at the same time. Increments down to .00005" / .001mm. Comes with Dust Cap and Flat Back.

Built in Wireless & USB Cable Connect



A3110-GSG1 .600" Travel Range \$ 440.00

GSG Mini Logic

"AGD Group 1 size" (1.70" diameter)



The Mini Logic IQ is loaded with basic and advanced features that are easy to operate. Featuring .400" of travel and increments down to .00005. Comes with Flat Back (Optional Lug Back Available)

MQ3665-0-48 .400" Travel Range \$ 460.00

Connect without wires...

Download the free indicator app for Android or Apple iOS Devices, Just search for "Electronic Dial Indicator"

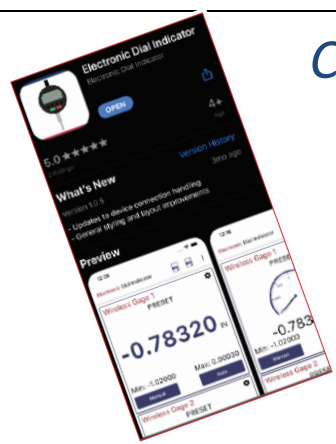

NEW PRODUCTS

GSG MECHANICAL INDICATORS

All indicators available with certification - \$30.00 each

Group 2 mechanical indicator with 1.0" of travel in .001" increments w/counter. Available in flat or lug back.

26104CJ-GSG 1.000 Travel Range \$ 135.00



Group 2 mechanical indicator with 1.000 of travel in .0005 increments w/counter. Available in flat or lug back. (Counterclockwise Dial)

26103CCJ-GSG 1.0000" Travel Range \$ 135.00

All GSG Mechanical Indicators available in Metric!

GSG MECHANICAL "CHAMFER GAGE" INDICATORS

Group 2 Chamfer Gage (90°) indicator .500" or 1.000 travel in .001 increments w/counter. Available with flat back. Both English and Metric with 2:1 Ratio

26103CCJ-GSG 0° - 90° w/1.00" Travel Range \$ 165.00 (Standard)
52135CC-GSG 0° - 90° w/13.5mm Travel Range \$ 165.00 (Metric)



Many other indicators available.. Check out our website for more info!

GSG INDICATOR ACCESSORIES

NEW PRODUCTS

GSG Digital Indicator Guard

Protect your investment with a protective guard. Our guards were specifically designed to allow access to data cable ports and battery compartments. They can also be used in conjunction with the GSG Chamfer Gage and our line of Penetration Gages



CG150D	Protective Guard	\$	65.00	(Digital Gages)
CG150M	Protective Guard	\$	65.00	(Mechanical Gages)



GSG SPS CABLES

G13-0055	USB Connector - 12ft length	\$	68.00
G03-0019	MTI Connector - 6ft length	\$	96.00

Our cables are supplied in 6' lengths. USB available in 12' by request.

GRANITE STANDS

Black Granite Base Comparators designed to meet the requirements of both the large and small shop. Several sizes available, with or without fine adjustment.

MODEL	Base Size	Stem/Lug Mount	Column Height	Fine Adjustment	Price
6066	6" x 6" x 2"	LUG	8.00"	NO	\$ 430.00
6066-20S	6" x 6" x 2"	STEM	8.00"	YES	\$ 430.00
60812-1S	6" x 6" x 2"	STEM	12.00"	YES	\$ 535.00
60812-1	6" x 6" x 2"	LUG	12.00"	YES	\$ 535.00



Model 6066 shown

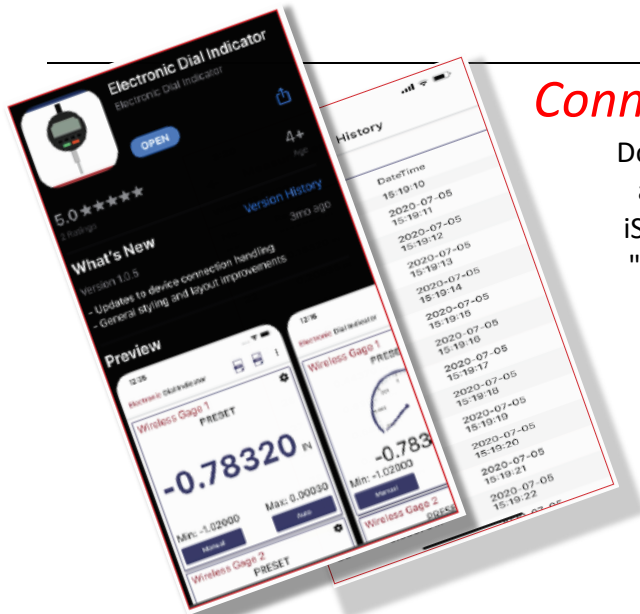

Connect without wires...

Download the free indicator app for Android or Apple iSO Devices, Just search for "Electronic Dial Indicator" in your app store

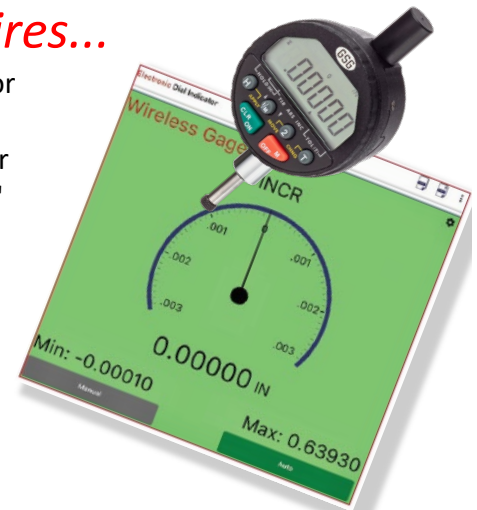

NEW PRODUCT LISTING

GSG Hex Plug Gages

HEX & SQUARE GAGES AVAILABLE IN ANY SIZE,
CALL FACTORY FOR SIZES NOT FOUND BELOW

Our gages are manufactured to B18.3-2012 standards. Custom sizes available.

Hex Rings also available upon request!

Call Factory for a quote.

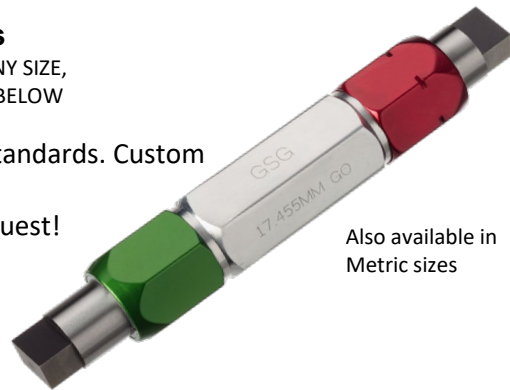

Also available in Metric sizes

* For custom size pricing, use the price of the next size up on the chart below.

Certification add \$30.00 per member / \$60.00 per set

Nominal Size Across Flats		GO / NO-GO	PRICE	PRICE	PRICE	SOLD SEPARATELY
FRACTIONAL	DECIMAL FORM	TOLERANCE	GO MBR ONLY	NOGO MBR ONLY	NOGO MBR ONLY	HANDLE
			HEX SHAPE	HEX SHAPE	RECTANGULAR SHAPE	REVERSIBLE STYLE
7/64	0.1094	±0.0002	\$ 193.00	\$ 193.00	\$ 154.00	#3 W DE \$14.00
1/8	0.125		\$ 193.00	\$ 193.00	\$ 154.00	#3 W DE \$14.00
5/32	0.1562		\$ 193.00	\$ 193.00	\$ 154.00	#3 W DE \$14.00
3/16	0.1875		\$ 193.00	\$ 193.00	\$ 154.00	#3 W DE \$14.00
13/64	0.2031		\$ 193.00	\$ 193.00	\$ 154.00	#3 W DE \$14.00
7/32	.2188		\$ 182.00	\$ 182.00	\$ 146.00	#3 W DE \$14.00
15/64	0.2344		\$ 182.00	\$ 182.00	\$ 146.00	#3 W DE \$14.00
1/4	0.25		\$ 182.00	\$ 182.00	\$ 146.00	#4 W DE \$15.00
17/64	0.2656		\$ 182.00	\$ 182.00	\$ 146.00	#4 W DE \$15.00
9/32	0.2812		\$ 182.00	\$ 182.00	\$ 146.00	#4 W DE \$15.00
19/64	0.2969		\$ 182.00	\$ 182.00	\$ 146.00	#4 W DE \$15.00
5/16	0.3125		\$ 182.00	\$ 182.00	\$ 146.00	#4 W DE \$15.00
11/32	0.3438		\$ 182.00	\$ 182.00	\$ 146.00	#4 W DE \$15.00
3/8	0.375		\$ 182.00	\$ 182.00	\$ 146.00	#5 W DE \$15.00
13/32	0.4062		\$ 182.00	\$ 182.00	\$ 146.00	#5 W DE \$15.00
7/16	0.4375		\$ 198.00	\$ 198.00	\$ 159.00	#5 W DE \$15.00
1/2	0.5		\$ 198.00	\$ 198.00	\$ 159.00	#6 W DE \$16.00
9/16	0.5625		\$ 198.00	\$ 198.00	\$ 159.00	#7 W DE \$16.00
5/8	0.625	±0.0003	\$ 198.00	\$ 198.00	\$ 159.00	#7 W DE \$16.00
11/16	0.6875		\$ 198.00	\$ 198.00	\$ 159.00	#8 W DE \$24.00
3/4	0.75		\$ 209.00	\$ 209.00	\$ 168.00	#8 W DE \$24.00
13/16	0.8125		\$ 209.00	\$ 209.00	\$ 168.00	#8 W DE \$24.00
7/8	0.875		\$ 209.00	\$ 209.00	\$ 168.00	#8 W DE \$24.00
15/16	0.9375		\$ 209.00	\$ 209.00	\$ 168.00	#8 W DE \$24.00
1	1		\$ 232.00	\$ 232.00	\$ 185.00	#8 W DE \$24.00
1 1/16	1.0625		\$ 232.00	\$ 232.00	\$ 185.00	#8 W DE \$24.00
1 1/8	1.125	±0.0004	\$ 232.00	\$ 232.00	\$ 185.00	#8 W DE \$24.00
1 3/16	1.1875		\$ 248.00	\$ 248.00	\$ 198.00	#8 W DE \$24.00
1 1/4	1.25		\$ 248.00	\$ 248.00	\$ 198.00	#8 W DE \$24.00
1 5/16	1.3125		\$ 248.00	\$ 248.00	\$ 198.00	#8 W DE \$24.00
1 3/8	1.375		\$ 248.00	\$ 248.00	\$ 198.00	#8 W DE \$24.00
1 7/16	1.4375		\$ 248.00	\$ 248.00	\$ 198.00	#8 W DE \$24.00
1 1/2	1.5		\$ 248.00	\$ 248.00	\$ 198.00	#8 W DE \$24.00
1 5/8	1.625	±0.0005	\$ 248.00	\$ 248.00	\$ 198.00	#8 W DE \$24.00
1 11/16	1.6875		\$ 303.00	\$ 303.00	\$ 243.00	#8 W DE \$24.00
1 3/4	1.75		\$ 303.00	\$ 303.00	\$ 243.00	#8 W DE \$24.00
1 13/16	1.8125		\$ 303.00	\$ 303.00	\$ 243.00	#8 W DE \$24.00
1 7/8	1.875		\$ 303.00	\$ 303.00	\$ 243.00	#8 W DE \$24.00
1 15/16	1.9375		\$ 303.00	\$ 303.00	\$ 287.00	#8 W DE \$24.00
2	2		\$ 358.00	\$ 358.00	\$ 287.00	#8 W DE \$24.00
2 1/16	2.0625		\$ 358.00	\$ 358.00	\$ 287.00	#8 W DE \$24.00
2 3/16	2.1875	±0.0006	\$ 358.00	\$ 358.00	\$ 287.00	#8 W DE \$24.00
2 1/4	2.25		\$ 358.00	\$ 358.00	\$ 287.00	#8 W DE \$24.00
2 3/8	2.375		\$ 358.00	\$ 358.00	\$ 287.00	#8 W DE \$24.00
2 7/16	2.4375		\$ 375.00	\$ 375.00	\$ 300.00	#8 W DE \$24.00
2 9/16	2		\$ 375.00	\$ 375.00	\$ 300.00	#8 W DE \$24.00
2 5/8	2.625		\$ 375.00	\$ 375.00	\$ 300.00	#8 W DE \$24.00
2 3/4	2.75		\$ 375.00	\$ 375.00	\$ 300.00	#8 W DE \$24.00
2 13/16	2.8125		\$ 375.00	\$ 375.00	\$ 300.00	#8 W DE \$24.00
2 7/8	2.875		\$ 375.00	\$ 375.00	\$ 300.00	#8 W DE \$24.00
2 15/16	2.9375		\$ 375.00	\$ 375.00	\$ 300.00	#8 W DE \$24.00

DECIMAL EQUIVALENT CHART

Conversions for Number/Letter Drills, Metric Measurements and Fractional Sizes

# 97 .0059	# 67 .0320	# 39 .0995	5mm .1969	8mm .3150	15.5mm .6102
.15mm .0059	# 66 .0330	# 36 .1015	# 8 .1990	0 .3160	5/8 .6250
# 96 .0063	.85mm .0335	2.6mm .1024	5.1mm .2008	8.1mm .3189	16mm .6299
.16mm .0063	# 65 .0350	# 37 .1040	# 7 .2010	8.2mm .3228	41/64 .6406
# 95 .0067	.9 mm .0354	2.7mm .1063	13/64 .2031	P .3230	16.5mm .6496
.17mm .0067	# 64 .0360	# 36 .1065	# 6 .2040	8.25mm .3248	21/32 .6562
# 94 .0071	# 63 .0370	2.75mm .1083	5.2mm .2047	8.3mm .3268	17mm .6693
.18mm .0071	.95mm .0374	7/64 .1094	# 5 .2055	21/64 .3281	43/64 .6719
# 93 .0075	# 62 .0380	# 35 .1100	5.25mm .2067	8.4mm .3307	11/16 .6875
.19mm .0075	# 61 .0390	2.8mm .1102	5.3mm .2087	Q .3320	17.5mm .6890
# 92 .0079	1.0 mm .0394	# 34 .1110	# 4 .2090	8.5mm .3346	45/64 .7031
.2mm .0079	# 60 .0400	# 33 .1130	5.4mm .2126	8.6mm .3386	18mm .7087
# 91 .0083	# 59 .0410	2.9mm .1142	# 3 .2130	R .3390	23/32 .7188
.21mm .0083	1.05mm .0413	# 32 .1160	5.5mm .2165	8.7mm .3425	18.5mm .7283
# 90 .0087	# 58 .042	3mm .1181	7/32 .2188	11/32 .3438	47/64 .7344
.22mm .0087	# 57 .043	# 31 .1200	5.6mm .2205	8.75mm .3445	19mm .7480
# 89 .0091	1.1mm .0433	3.1mm .1220	# 2 .2210	8.8mm .3465	3/4 .7500
.23mm .0091	1.15mm .0453	1/8 .1250	5.7mm .2244	S .3480	49/64 .7656
.24mm .0094	# 56 .0465	3.2mm .1260	5.75mm .2264	8.9mm .3504	19.5mm .7677
# 88 .0095	3/64 .0469	3.25mm .1280	# 1 .2280	9mm .3543	25/32 .7812
.25mm .0098	1.2mm .0472	# 30 .1285	5.8mm .2283	T .3580	20mm .7874
# 87 .0100	1.25mm .0492	3.3mm .1299	5.9mm .2323	9.1mm .3583	51/64 .7969
.26mm .0102	1.3mm .0512	3.4mm .1339	A .2340	23/64 .3594	20.5mm .8071
# 86 .0105	# 55 .0520	# 29 .1360	15/64 .2344	9.2mm .3622	13/16 .8125
.27mm .0106	1.35mm .0531	3.5mm .1378	6mm .2362	9.25mm .3642	21mm .8268
# 85 .0110	# 54 .0550	# 28 .1405	B .2380	9.3mm .3661	53/64 .8281
.28mm .0110	1.4mm .0551	9/64 .1406	6.1mm .2402	U .3680	27/32 .8438
.29mm .0114	1.45mm .0571	3.6mm .1417	C .2420	9.4mm .3701	21.5mm .8465
# 84 .0115	1.5mm .0591	# 27 .1440	6.2mm .2441	9.5mm .3740	55/64 .8594
.3mm .0118	# 53 .0595	3.7mm .1457	D .2480	3/8 .3750	22mm .8661
# 83 .0120	1.55mm .0610	# 26 .1470	6.25mm .2461	V .3770	7/8 .8750
# 82 .0125	1/16 .0625	3.75mm .1476	6.3mm .2480	9.6mm .3780	22.25mm .8760
.32mm .0126	1.6mm .0630	# 25 .1495	E .2500	9.7mm .3819	22.5mm .8858
# 81 .0130	# 52 .0635	3.8mm .1496	1/4 .2500	9.75mm .3839	57/64 .8906
.34mm .0134	1.65mm .0650	# 24 .1520	6.4mm .2520	9.8mm .3858	23mm .9055
# 80 .0135	1.7mm .0669	3.9mm .1535	6.5mm .2559	W .3880	29/32 .9062
.35mm .0138	# 51 .0870	# 23 .1540	F .2570	9.9mm .3898	59/64 .9219
.36mm .0142	1.75mm .0689	5/32 .1562	6.6mm .2598	25/64 .3906	23.5mm .9252
# 79 .0145	# 50 .0700	# 22 .1570	G .2610	10mm .3937	15/16 .9375
.38mm .0150	1.8mm .0709	4mm .1575	6.7mm .2638	X .3970	24mm .9449
1/64 .0156	1.85mm .0728	# 21 .1590	17/64 .2656	Y .4040	61/64 .9531
.4mm .0157	# 49 .0730	# 20 .1610	6.75mm .2657	13/32 .4062	24.5mm .9646
# 78 .0160	1.9mm .0748	4.1mm .1614	H .2860	Z .4130	31/32 .9688
.42mm .0165	# 48 .0760	4.2mm .1654	6.8mm .2677	10.5mm .4134	25mm .9843
.44mm .0173	1.95mm .0768	# 19 .1680	6.9mm .2717	27/64 .4219	63/64 .9844
.45mm .0177	5/64 .0781	4.25mm .1873	I .2720	11mm .4331	1 - 1.0000
# 77 .0180	# 47 .0785	4.3mm .1693	7mm .2756	7/16 .4375	25.5mm 1.0039
.46mm .0181	2mm .0787	# 18 .1695	J .2770	11.5mm .4528	1-1/64 1.0156
.48mm .0189	2.05mm .0807	11/64 .1719	7.1mm .2795	29/64 .4531	26mm 1.0236
.5mm .0197	# 46 .0810	# 17 .1730	K .2810	15/32 .4688	1-1/32 1.0312
# 76 .0200	# 45 .0820	4.4mm .1732	9/32 .2812	12mm .4724	26.5mm 1.0433
# 75 .0210	2.1mm .0827	# 16 .1770	7.2mm .2835	31/64 .4844	1-3/64 1.0469
.55mm .0217	2.15mm .0846	4.5mm .1772	7.25mm .2854	12.5mm .4921	1-1/16 1.0625
# 74 .0225	# 44 .0880	# 15 .1800	7.3mm .2874	1/2 .5000	27mm 1.0630
.6mm .0236	2.2mm .0886	4.6mm .1811	L .2900	13mm .5118	1-5/64 1.0781
# 73 .0240	2.25mm .0886	# 14 .1820	7.4mm .2913	33/64 .5156	27.5mm 1.0827
# 72 .0250	# 43 .0890	# 13 .1850	M .2950	17/32 .5312	1-3/32 1.0938
.65mm .0256	2.3mm .0906	4.7mm .1850	7.5mm .2953	13.5mm .5315	28mm 1.1024
# 71 .0260	2.35mm .0925	4.75mm .1870	19/64 .2969	35/64 .5469	1-7/64 1.1094
.7mm .0276	# 42 .0935	3/16 .1875	7.6mm .2992	14mm .5512	28.5mm 1.1220
# 70 .0280	3/32 .0938	4.8mm .1890	N .3020	9/16 .5620	1-1/8 1.1250
# 69 .0292	2.4mm .0945	# 12 .1890	7.7mm .3031	14.5mm .5709	19/64 1.1406
.75mm .0295	# 41 .0960	# 11 .1910	7.75mm .3051	37/64 .5781	29mm 1.1417
# 68 .0310	2.45mm .0965	4.9mm .1929	7.8mm .3071	15mm .5906	15/32 1.1562
1/32 .0312	# 40 .0980	# 10 .1935	7.9mm .3110	19/32 .5938	29.5mm 1.1614
.8 mm .0315	2.5mm .0984	#9 .1960	5/16 .3125	39/64 .6094	1 11/64 1.1719

GLASTONBURY SOUTHERN GAGE™

GLASTONBURY SOUTHERN GAGE
46 INDUSTRIAL PARK ROAD
ERIN, TN 37061
Ph; 800-251-4243

WWW.GSGAGE.COM



GLASTONBURY SOUTHERN GAGE
87 UPTON ROAD
COLCHESTER, CT 06415
Ph; 860-537-7340

OUR PRODUCT LINES INCLUDE BUT ARE NOT LIMITED TO:

- *Thread Plugs
- *Snap Gages
- *ID & OD Segments
- *Chamfer Gages
- *Service Tooling
- *Cylindrical Rings
- *Hexalobe Gages
- *Snap Gages
- *Hex Gages
- *Thread Rings
- *Zero Spindles
- *Part-Like Masters
- *Design & Build
- *Work Holding Fixtures
- *Steel, Chrome & Carbide Pins
- *Mic Masters
- *Variable Thread Gaging Systems
- *Oblong Gages
- *Master Setting Disc's
- *Cylindrical Plugs
- *Medical Gages
- *API Gages
- *Tri-Roll Comparators
- *Thread Work Plugs
- *CMM Artifacts
- *Calibration Services
- *Grinding Services

Gages manufactured from many materials including Steel, Stainless & Carbide



Need it fast?
Redline Service
available

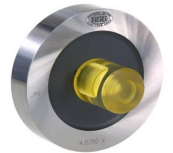
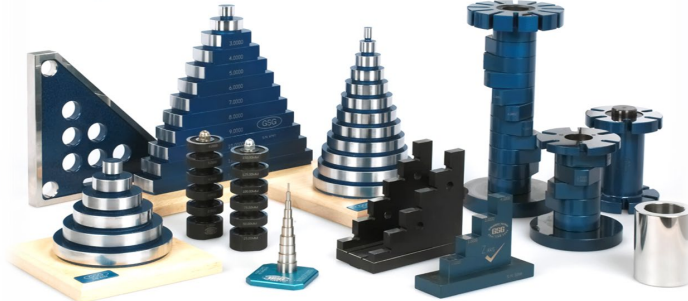

www.gsgage.com



GSG...YOUR SOURCE FOR SPECIAL GAGES

MOBILE FRIENDLY, JUST SCAN THE CODES ON THE PAGES FOR
ADDITIONAL PRODUCT INFO

