

THE BASICS OF LIMIT GAGING



455 Douglas Ave. Holland Mi 49424
Tel. 616-396-4604 Fax. 616-396-0413
www.hemcogages.com

**DESCRIPTION AND
BASIC TERMINOLOGY
OF LIMIT GAGING**

**CYLINDRICAL GAGE
DESIGN AND USE**

Limit Gaging

What is Limit gaging?

Limit gaging is the most basic method of assuring manufacturing that its products are meeting its most basic tolerances, and that it will function as required in final assembly. Typically it has 2 gaging members 1 representing the maximum material condition, 1 representing the minimum material condition.

How does it Function?

In general when we discuss limit or functional gaging we talk about Go and No-Go gaging.

* The Go gage represents the product at its Maximum Material Condition and verifies that it has not been exceeded.

* The No-Go gage represents the product at its Minimum Material Condition and verifies that it has not been exceeded.

Limit gaging strengths

- Fast and sure qualification of product,
- Requires minimal training.
- Indicates the product will assemble and function as intended.
- Economical
- Minimal maintenance.

Limit Gaging Terms

Maximum Material Condition as Pertaining to Internal Diameters.

Maximum Material Condition is the condition of the part when the greatest amount of material remains on the part and still being within its tolerance limits. (Minimum bore size.)

Minimum Material Condition as Pertaining to Internal Diameters.

Minimum Material Condition is the condition of the part when the least amount of material remains on the part and still being within its tolerance limits. (Maximum bore size.)

INTERNAL PRODUCT

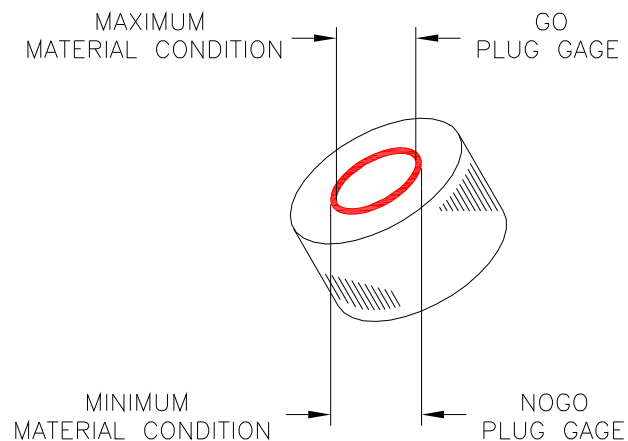

Maximum Material Condition as Pertaining to External Diameters.

Is the condition of the part when the greatest amount of material remains on the part and still being within its tolerance limits. (Maximum shaft size.)

Minimum Material Condition as Pertaining to External Diameters.

Is the condition of the part when the least amount of material remains on the part and still being within its tolerance limits. (Minimum shaft size.)

EXTERNAL PRODUCT

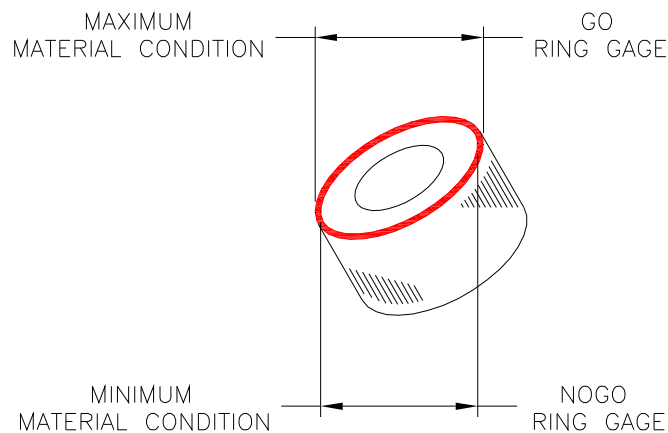

Functional Size

Is the accumulation of all the dimensions and features involved in a part.

Assemble-ability

Is the assurance that when the accumulation of the mating products features when at maximum material condition will fit and perform as designed.

Go Gage

Represents the Maximum Material Condition and verifies that it has not been exceeded.

No-Go Gage

Represents the Minimum Material Condition and verifies that it has not been exceeded.

Cylindrical Gaging

The Design, Intent, Selection, and Use of Cylindrical Gaging

Reference ASME B89.1.5-1998 for Master Discs or Cylindrical Plug Gages.

Reference ANSI/ASME B89.1.6M-1984 for Master Rings and Ring Gages.

DESIGN- Gage blank design as shown in ASME/ANSI B47.1-1988

Cylindrical Ring Gage Blank – Size Range .010 – 12.260

The design of the plain cylindrical ring blank has a knurled O.D. and length proportional to its size range. Blank sizes over 1.510 are flanged to eliminate unnecessary weight. When used as a limit gages the No-Go will have an annular groove in the knurled O.D. to identify it as such. Master setting rings use the same blank design and identified as Min., Max., or Mean.

CYLINDRICAL RING GAGES / MASTER SETTING RINGS

BLANK	INCH RANGE		METRIC RANGE		O.D.	LENGTH	BLANK	INCH RANGE		METRIC RANGE		O.D.	LENGTH
	ABOVE	TO & INCL	ABOVE	TO & INCL				ABOVE	TO & INCL	ABOVE	TO & INCL		
#00	.010	.150	1.02	3.81	.937	.187	#11	4.010	4.760	101.85	120.90	7.250	1.500
#0	.150	.230	3.81	5.84	.937	.375	#12	4.760	5.510	120.90	139.95	8.250	1.500
#1	.230	.365	5.84	9.27	1.125	.562	#13	5.510	6.260	139.95	159.00	9.250	1.500
#2	.365	.510	9.27	12.95	1.375	.750	#14	6.260	7.010	159.00	178.05	10.250	1.500
#3	.510	.825	12.95	20.96	1.750	.937	#15	7.010	7.760	178.05	197.10	11.250	1.500
#4	.825	1.135	20.96	28.83	2.125	1.125	#16	7.760	8.510	197.10	216.15	12.250	1.500
#5	1.135	1.510	28.83	38.35	2.500	1.312	#17	8.510	9.260	216.15	235.20	13.250	1.500
#6	1.510	2.010	38.35	51.05	4.000	1.500	#18	9.260	10.010	235.20	254.25	14.250	1.500
#7	2.010	2.510	51.05	63.75	4.500	1.500	#19	10.010	10.760	254.25	273.30	15.250	1.500
#8	2.510	3.010	63.75	76.45	5.000	1.500	#20	10.760	11.510	273.30	292.35	16.250	1.500
#9	3.010	3.510	76.45	89.15	5.500	1.500	#21	11.510	12.260	292.35	311.40	17.250	1.500
#10	3.510	4.010	89.15	101.85	6.250	1.500							

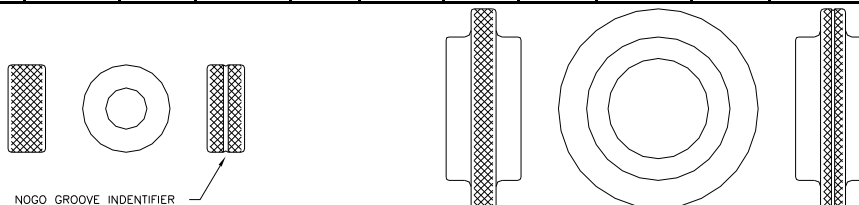

Cylindrical Plug Gage Blank – Size Range .010 – 8.010 and Larger

The design of a cylindrical plug gage involves 4 individual blank designs.

1) Wire Type Design – Range .010 – 1.010 inch.

Wire type gage blank also known as reversible or Pin gages. The gage mounts in a Double or Single ended collet handle. The Go gage is identified with a Green collet nut; the No-Go gage is identified with a Red collet nut which also has an annular groove cut around the hex diameter. Both gaging members can be reversed for extended gage life making this design the most economical gage design.

CYLINDRICAL REVERSIBLE GAGES

HANDLE DOUBLE END	HANDLE SINGLE END	INCH RANGE		METRIC RANGE		BLANK LENGTH
		ABOVE	TO & INCL	ABOVE	TO & INCL	
1W	1W-S	.010	.075	0.25	1.91	1.000
2W	2W-S	.075	.180	1.91	4.57	1.250
3W	3W-S	.180	.281	4.57	7.14	1.500
4W	4W-S	.281	.406	7.14	10.31	1.750
5W	5W-S	.406	.510	10.31	12.95	2.000
6W	6W-S	.510	.635	12.95	16.13	2.000
7W	7W-S	.635	.760	16.13	19.30	2.000
8W	8-WS	.760	1.010	19.30	25.65	2.000

* AT MANUFACTURES DESCRETION BLANK LENGTH MAY BE LONGER

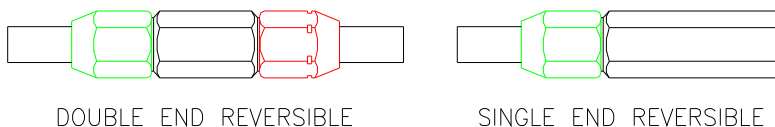
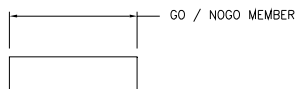

2) Taper-Lock Type Design – Range .059 – 1.510 inch.

Taper-lock Type gage blanks are designed with a tapered shank mounting into a handle with a tapered hole. The taper-lock can not be reversed and prevents the accidental use of a portion of the gage that is worn out of tolerance. Go and No-Go gages are identified by the length of the gaging member with the Go member being longer than the No-Go member.

TAPERLOCK CYLINDRICAL GAGE						
HANDLE	INCH RANGE		METRIC RANGE		GO LENGTH	NOGO LENGTH
	ABOVE	TO & INCL	ABOVE	TO & INCL		
#000	.059	.105	1.50	2.67	.375	.187
#00	.105	.150	2.67	3.81	.375	.218
#0	.150	.230	3.81	5.84	.406	.281
#1	.230	.365	5.84	9.27	.750	.312
#2	.365	.510	9.27	12.95	1.000	.375
#3	.510	.825	12.95	20.96	1.250	.500
#4	.825	1.135	20.96	28.83	1.500	.625
#5	1.135	1.510	28.83	38.35	1.625	.750

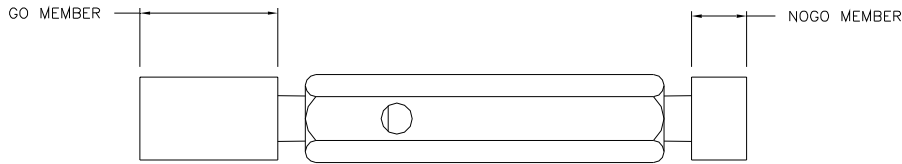

3) Tri-Lock Type Design – Range .760 – 8.010 inch.

Tri-Lock Type gage blanks are designed with a 3 face notches equally spaced around a counter bored thru hole. The gaging mounts on a Double or Single ended handle with 3 matching lugs and a tapped hole using a cap screw. Go and No-Go gages are identified by the length of the gaging member with the Go member being longer than the No-Go member. Gages over 4 inches in diameter will use individual single ended handles for the Go and No-Go members to reduce weight concerns. Both gaging members can be reversed for extended gage life.

TRILOCK CYLINDRICAL GAGE						
HANDLE	INCH RANGE		METRIC RANGE		GO LENGTH	NOGO LENGTH
	ABOVE	TO & INCL	ABOVE	TO & INCL		
2 1/2	.760	.947	19.30	24.05	1.250	.750
3 1/2	.947	1.135	24.05	28.83	1.375	.750
3 1/2	1.135	1.510	28.83	38.35	1.500	.750
5 1/2	1.510	2.010	38.35	51.05	1.875	.875
6	2.010	2.510	51.05	63.75	2.000	.875
7	2.510	3.510	63.75	89.15	2.000	1.000
7	3.510	8.010	89.15	203.45	2.125	1.000

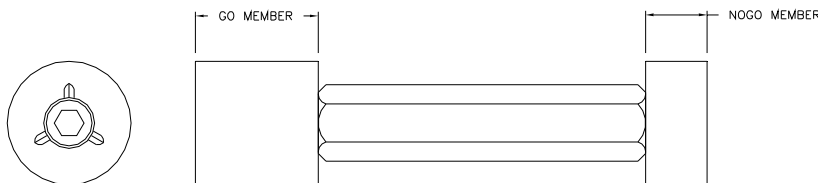

4) Annular Type Design – Range 8.010 – 12.010 inch.

Annular Type gage blanks are bored out to reduce weight and have 4 tapped holes to accommodate Ball type handles. Go and No-Go gages are identified by the length of the gaging member with the Go member being longer (2.250”) than the No-Go member (1.000”). Both gaging members can be reversed for extended gage life.

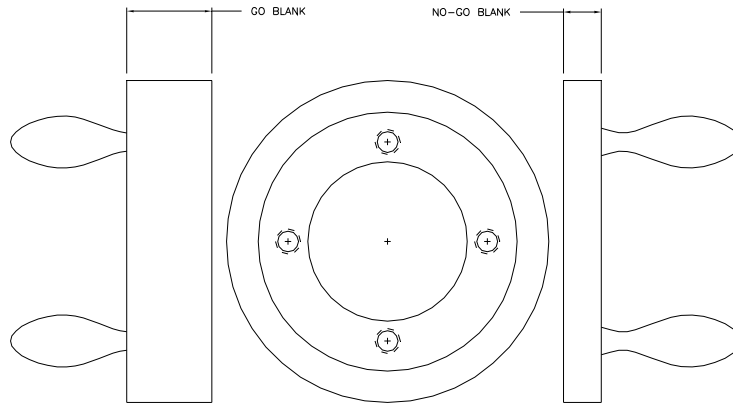

Intent- and purpose of limit gaging.

The intent and purpose of limit gaging, as applied to the bore and shaft diameter is to assure that the maximum and minimum functional size of its cylinder have not been exceeded and to ensure assemble-ability. Using simplistic tried, true, and economical methods.

Selection- of Gage Size and Tolerance.

Internal diameters or bores require the use of a Go / No-Go plug gage.

The Go plug gage represents the product at its **Maximum Material Condition.**

The No-Go plug gage represents the product at its **Minimum Material Condition.**

External diameters or shafts require the use of a Go / No-Go ring gage.

The Go ring gage represents the product at its **Maximum Material Condition.**

The No-Go ring gage represents the product at its **Minimum Material Condition.**

In determining the appropriate tolerance gage makers will use 10% of the product tolerance, 5% will be applied to the Go gage, 5% will be applied to the No-Go. It is a common practice to select a Tolerance one class smaller. In doing so, refer to the following chart (page 11) for the appropriate class designation.

The purpose of limit gage being is to not allow the product to exceed its maximum or minimum material condition, the direction of the gage tolerance is to move toward the products tolerance zone.

Cylindrical Plug gage	Go	+ tolerance
	No-Go	- tolerance

Cylindrical Ring gage	Go	- tolerance
	No-Go	+ tolerance

Tolerance on roundness and taper shall not exceed ½ the total tolerance on diameter.

Example:

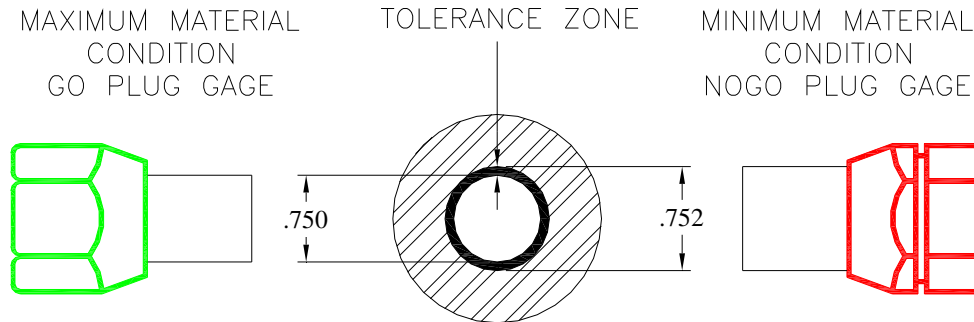

Size Determination

Using an example of a part having a bore of .750 / .752. The Go Plug gage is to be manufactured to the Maximum material condition size which is .750. The No-go Plug gage is to be manufactured to the Minimum material condition size which is .752.

Tolerance Selection

Tolerance selection is based on the gagemakers practice of allowing 10% of the products manufacturing tolerance for gaging. Based on a product having a size range of .750 / .752 a total tolerance of .002. 10% of the products tolerance is .0002, one half of this is applied to the Go gage, one half is applied to the No-go, based on our tolerance chart the tolerance selection would be Class Z or .0001”.

Gage Purchasing

To purchase this gage specify the following.
Go .750 / NoGo .752 Tolerance Class Z Reversible with Certification.

GAGE MAKERS TOLERANCE FOR CYLINDRICAL GAGES							
ABOVE	TO & INCL.	XXX	XX	X	Y	Z	ZZ
.010"	.825"	.000010	.000020	.00004	.00007	.00010	.00020
0.254mm	20.95mm	0.25um	0.51um	1.02um	1.78um	2.54um	5.08um
.825"	1.510"	.000015	.000030	.00006	.00009	.00012	.00024
20.95mm	38.35mm	0.38um	0.76um	1.52um	2.29um	3.05um	6.10um
1.510"	2.510"	.000020	.000040	.00008	.00012	.00016	.00032
38.35mm	63.75mm	0.51um	1.02um	2.03um	3.05um	4.06um	8.13um
2.510"	4.510"	.000025	.000050	.00010	.00015	.00020	.00040
63.75mm	114.55mm	0.64um	1.27um	2.54um	3.81um	5.08um	10.16um
4.510"	6.510"	.000033	.000065	.00013	.00019	.00025	.00050
114.55mm	165.35mm	0.84um	1.65um	3.30um	4.83um	6.35um	12.70um
6.510"	9.010"	.000040	.00008	.00016	.00024	.00032	.00064
165.35mm	228.85mm	1.02um	2.03um	4.06um	6.10um	8.13um	16.26um
9.010"	12.010"	.000050	.00010	.00020	.00030	.00040	.00080
228.85mm	305.95mm	1.27um	2.54um	5.08um	7.62um	10.16um	20.32um
12.010"	15.010"	.000075	.00015	.00030	.00045	.00060	.00120
305.05mm	381.25mm	1.90um	3.81um	7.62um	11.43um	15.24um	30.48um
15.010"	18.010"	.000100	.00020	.00040	.00060	.00080	.00160
381.25mm	457.45mm	2.54um	5.08um	10.16um	15.24um	20.32um	40.64um
18.010"	21.010"	.000125	.00025	.00050	.00075	.00100	.00200
457.45mm	533.65mm	3.18um	6.35um	12.70um	19.05um	25.40um	50.80um

Gaging options

The use of wear allowance.

The intent of wear allowance on a gage is to increase the wear life of the Go gaging member. The Go member size selection is increased beyond the maximum material condition by an amount agreed upon by manufacturing and quality. Once this determination is made the Go member is to be purchased to this size and allowed to wear to its maximum material condition.

Example: Based on the example in figure 6 with a .750 / .752 product size. The standard Go member would be .750 with a + Z tolerance. When manufacturing allows adding a .0001 for wear now making the Go member .7501 with a + Z tolerance will increase the life of the gage substantially with minimal affect on manufacturing. The benefits included reduced gage purchases and extended periods between calibrations.

When purchasing the gage specify a .7501 Go a .7520 No-Go with a handle. The gage should be marked .7500 Go .0001 W.A. 7520 No-Go Class Z.

Entry Options

Several options are available to help reduce wear at the entrance area of the plug or ring, as well as help assist in the application of the gage, these include a chamfer, radius, or pilot. Typically this is added to the Go member only as the No-Go member is not expected to enter.

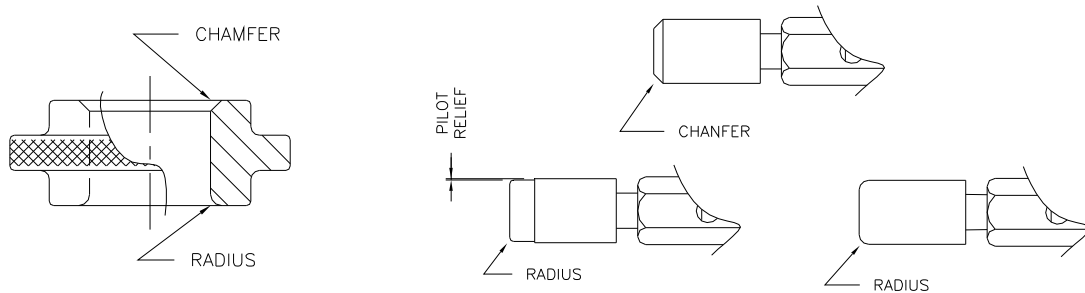

Depth Notch

When inspecting a hole or bore where a depth is controlled it is common practice to include depth notches. Depth notches representing the minimum and maximum length are ground onto the O.D. of the Go plug gage. 2 styles of notches are used, the whistle notch is generally used on Reversible gages, and the standard depth notch typically is used on Taperlock or Trilock plug gages.

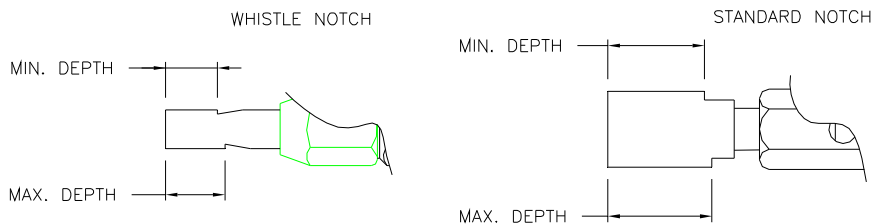

Air Vent

When gaging tight toleranced holes it is common have air lock. To alleviate this it is recommended to have an air vent ground parallel to the O.D. of the Go plug gage to allow air release.

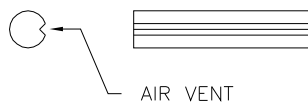

Straightness Gage

It is common when the length of a bore exceeds 4 times or more than that of the bore to see a straightness call out, a method to assure the product is functionally acceptable is the use of an alignment plug. The design of the alignment plug is to make a plug gage equal to the length of the product. The plug diameter is to equal to the product at its maximum material condition minus the straightness tolerance.

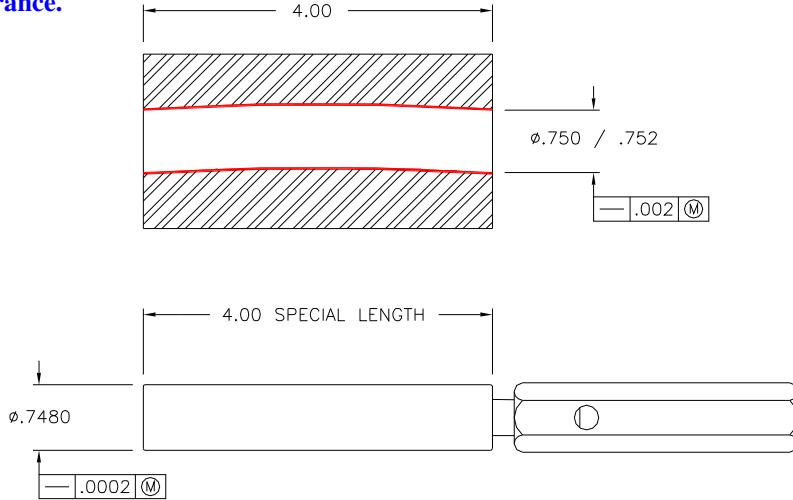

True Position Gage

The True Position gage is generally designed to assure the functional position of a datum diameter and 1 or more additional diameters, and assure the diameters are aligned within acceptable limits assuring assemble-ability.

In designing a True Position Gage the “datum diameter” of the plug gage is manufactured to the maximum material condition and a Go plug gage tolerance applied. To properly gage the position of the associated diameters, take the diameters maximum material condition, minus the products positional tolerance and apply a Go plug tolerance.

Additional gaging for this application is a .5000/.5005 plug gage with an extra length Go member to accommodate the extra length of the product. To check the counter bore a 1.000/.990 plug gage with .500/.531 depth notches.

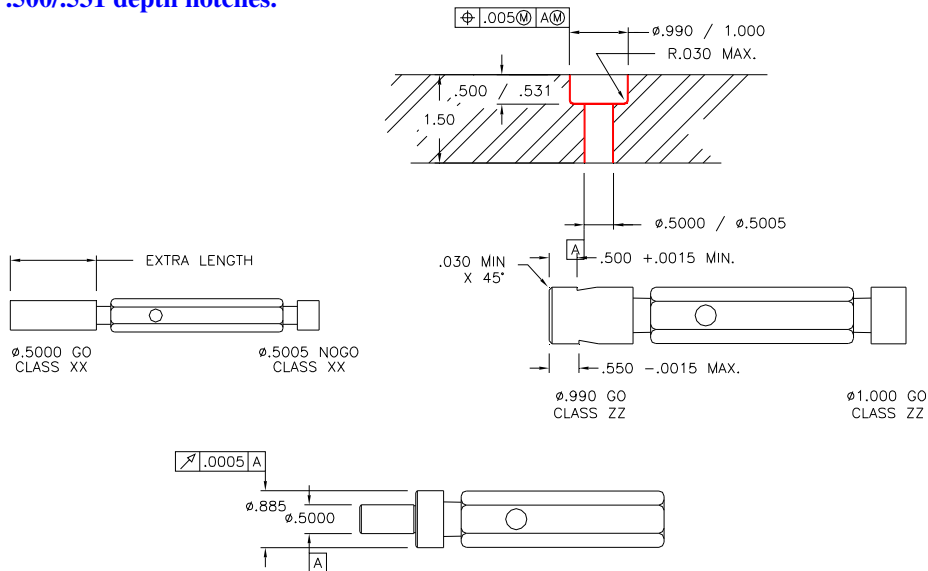

Flatted No-Go Plug

The purpose of the No-Go gage is to assure that the functional bore of a cylinder has not been exceeded at its maximum material condition, a No-Go plug gage could however accept product where a portion of the cylinder may be oversized due to ovality. To detect this condition a No-Go plug may be flatted or diamond relieved and, when applied to the product, rotated checking the entire cylinder for an oversized condition. Typically the plug gage is flatted to 1/3 of its diameter for a minimum length equal to the diameter.

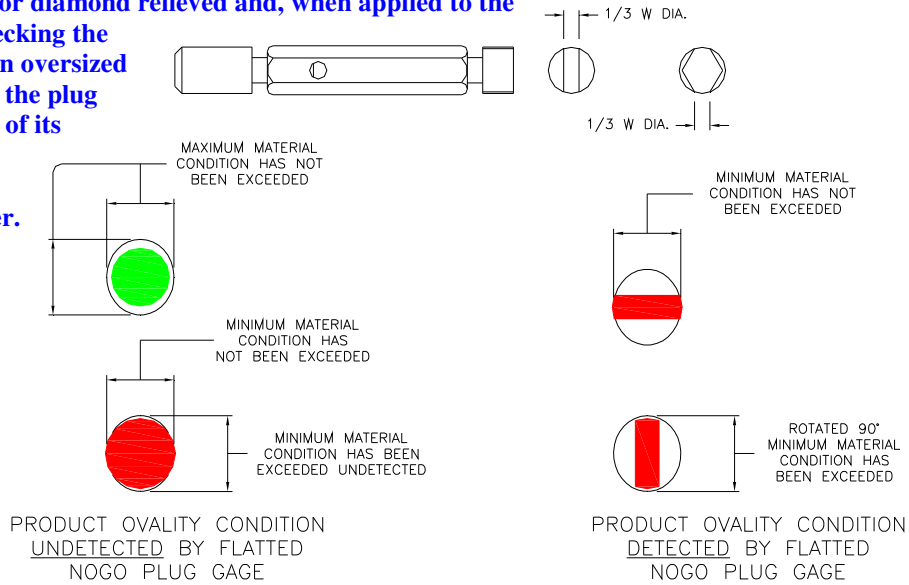

Progressive Gage

The progressive gage is when the Go and No-Go gages are on the same gage member. The benefit of this is speed and convenience. The negative is when the Go portion wears the entire gage will have to be replaced.

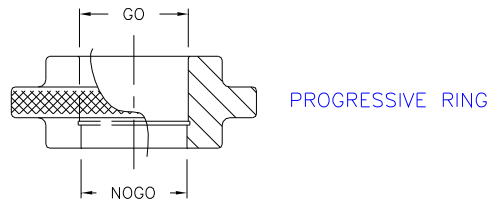

Long Go Gage

Standard extra length gage blanks are available. These are commonly used for applications where extra deep holes, bores, or recesses occur. In most cases this is only applied to the Go member as the No-Go member is not expected to enter.

PROGRESSIVE / EXTRA LENGTH TAPERLOCK DESIGN

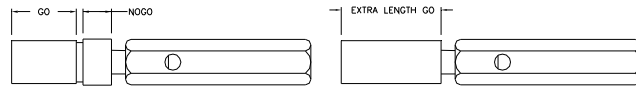

TAPERLOCK PROGRESSIVE CYLINDRICAL GAGE							
HANDLE	INCH RANGE		METRIC RANGE		GO LENGTH	NOGO LENGTH	EXTRA LENGTH
	ABOVE	TO & INCL	ABOVE	TO & INCL			
#000	.059	.105	1.50	2.67	.375	.187	.687
#00	.105	.150	2.67	3.81	.375	.218	.718
#0	.150	.230	3.81	5.84	.406	.281	.812
#1	.230	.365	5.84	9.27	.750	.312	1.187
#2	.365	.510	9.27	12.95	1.000	.375	1.500
#3	.510	.825	12.95	20.96	1.250	.500	1.875
#4	.825	1.135	20.96	28.83	1.375	.625	2.125
#5	1.135	1.510	28.83	38.35	1.500	.750	2.125

PROGRESSIVE GAGE TRILOCK DESIGN

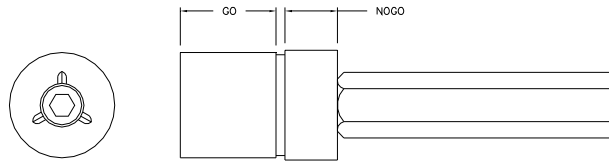

TRILOCK PROGRESSIVE CYLINDRICAL GAGE						
HANDLE	INCH RANGE		METRIC RANGE		GO LENGTH	NOGO LENGTH
	ABOVE	TO & INCL	ABOVE	TO & INCL		
5 1/2	1.510	2.010	38.35	51.05	1.875	.875
6	2.010	2.510	51.05	63.75	2.000	.875
7	2.510	3.510	63.75	89.15	2.000	.875
7	3.510	4.510	89.15	114.55	2.125	.875

Gage Certification

A gage certificate is available for gages giving the as measured dimension at the factory, however, it is the users obligation to verify the gage meets their own internal requirements.

Standard Certification

A standard certification would include information such as nominal size, tolerance, and measurements at front, center, back, and 90 degrees. General tracking information is also included, such as purchase order number, gage number, and date of certification.

ISO Certification

The ISO certification includes the same information as a standard certification in addition to having uncertainty budgets, and is supported by an Accreditation Agency.

Proper Use of the Cylindrical Gage

Internal Product

- 1, Select the appropriate gage based on manufacturing requirements such as gage length, min. /max. size and tolerance.
- 2, Make sure the gage has been calibrated.
- 3, Make sure the gage temperature and product temperature are similar.
- 4, Make sure both the gage and part are clean and free of burrs.
- 5, Maintain a light coating of oil on the gaging members.
- 6, The Go member should go freely into the product indicating that the Maximum material condition (undersized) has not been exceeded.
- 7, The Not Go member should not go into the product indicating the minimum material condition (oversized) has not been exceeded.

External Product

- 1, Select the appropriate gage based on manufacturing requirements such as gage length, min. /max. size and tolerance.
- 2, Make sure the gage has been calibrated.
- 3, Make sure the gage temperature and product temperature are similar.
- 4, Make sure both the gage and part are clean and free of burrs.
- 5, Maintain a light coating of oil on the gages.
- 6, The Go ring should go freely onto the product indicating that the Maximum material condition (oversized) has not been exceeded.
- 7, The Not Go ring should not go onto the product indicating the minimum material condition (undersized) has not been exceeded.

Gage Identification.

Standard gage identification would include the following:

- Go size
- No Go size
- Tolerance
- Manufacture

Additional marking options

- Gage Number or Tool Number
- Part Number
- Operation Number

Metric Gages typically are supplied with Gold handles.

How to Order Gages

The necessary information to be provided include the following.

- Quantity required
- Go and or No-Go diameters
- Style of blank
- Handle if required
- Tolerance class
- Certification
- Options if necessary

If you are uncomfortable with specifying gaging requirements call the manufacture for assistance.

CYLINDRICAL PURCHASE OPTIONS							
QTY.	GO DIAMETER	NOGO DIAMETER	STYLE	HANDLE	TOLERANCE	CERT.	OPTIONS
			REVERSIBLE TAPERLOCK TRILOCK	SINGLE END OR DOUBLE END	XXX XX X Y Z ZZ	STANDARD OR ISO 17025	DEPTH NOTCH SPECIAL LENGTH CHAMFER RADIUS FLATTED NOGO PILOT
EXAMPLE 1	.7500	.7520	TAPERLOCK	DOUBLE END	Z	ISO 17025	.030 RAD GO

Master Setting Gage.

When a variable (indicating) gage is required such as a bore gage, air gage, or indicating snap gage a setting master is required. Indicating gages that measure internal diameters or bores require a master setting ring, where an indicating gage that gages an O.D. or shaft diameter require a master setting disk.

The gage configuration of the master setting ring is the same as the plain ring and is typically manufactured to the products Mean condition. A set of Minimum and Maximum master rings can also be used to verify the accuracy of the gage across the complete range of the system.

The design of the master setting ring is the same as that of the Go / No-Go plain cylindrical ring gage.

The master setting disc is designed with insulating grips and comes in Style 1, 2, and 3. Style 1 is the long master; Style 2 is to be used as a Min. / Max. master, and Style 3 is the short master.

Tolerance for setting masters use the same letter classification as limit gages. The selection of tolerance is the same 10% rule as limit gaging however this is for entire gaging system and allowance for inaccuracies in the indicating gage must also be taken into account. The direction of the tolerance for style 1 and 3 is bilateral which is a split tolerance going 1/2 + and 1/2 - from the mean size. For style 2 the tolerance is unilateral, minus on the maximum, plus on the minimum.

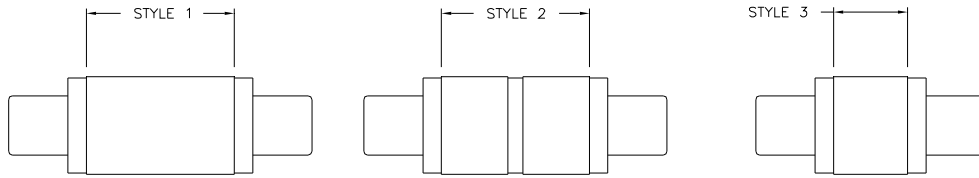

MASTER SETTING DISC						
GRIP	INCH RANGE		METRIC RANGE		STYLE 1 & 2	STYLE 3
	ABOVE	TO & INCL	ABOVE	TO & INCL	LENGTH	LENGTH
00	.105	.150	19.30	24.05	.750	.375
0	.150	.230	24.05	28.83	.875	.437
1	.230	.365	28.83	38.35	1.000	.500
2	.365	.510	38.35	51.05	1.125	.562
3	.510	.825	51.05	63.75	1.250	.625
4	.825	1.135	63.75	89.15	1.375	.687
5	1.135	1.510	89.15	203.45	1.625	.812
6	1.510	2.010	38.35	51.05	1.875	.875
6	2.010	2.510	51.05	63.75	2.000	.875
7	2.510	3.510	63.75	89.15	2.000	1.000
7	3.510	8.010	89.15	203.45	2.125	1.000

Gage Calibration

The frequency of a calibration is at the user's discretion. Determination should be based on frequency of use and environment.

In areas where calibrations are performed, the environment is considered critical.

- Cleanliness is critical, measuring equipment shall be shielded from smoke, dust, mist, and other contaminants.
- Vibration, all measuring equipment has to be shielded from vibration.
- Temperature, 68 +/- 2 degrees is the standard temperature at which all measurements should be taken. The gage and the equipment should at all times be at the same temperature.
- Humidity, should be held below 45% to reduce problems caused by rust and corrosion.

Also measurement uncertainty should at all times be taken into consideration, some of the areas affected are.

- Gage block stack up.
- Mechanical deformation.
- Thermo uncertainty.
- Instrument geometry.
- Reproducibility of mechanical comparison.

Typical acceptance criteria for calibration is to measure the gages in 3 planes, the mid section and 1/16" from each end, then rotate 90 degrees and measured in 3 additional planes.

Cylindrical gage acceptance or rejection criteria is based on the use of the full Tolerance Class and the Calibrators Uncertainty Budget.